

## Designated client product

This product will be discontinued its production in the near term.  
And it is provided for customers currently in use only, with a time limit.  
It can not be available for your new project. Please select other new or existing products.

For more information, please contact our sales office in your region.

New Japan Radio Co.,Ltd.

[www.njr.com](http://www.njr.com)

## HIGH PERFORMANCE LOW-NOISE DUAL OPERATIONAL AMPLIFIER

### ■ GENERAL DESCRIPTION

NJM2114 is a high performance dual low noise operational amplifier that could be replaced in application with NJM5532. Comparing to NJM5532; it has superior specifications on Slew Rate, Bandwidth and Offset Voltage. Furthermore lower noise and distortion are achieved, it is applicable for Hi-Fi audio equipments.

### ■ FEATURES

- Operating Voltage (  $\pm 3.0V \sim \pm 22.0V$  )
- High Slew Rate (  $15V/\mu s$  typ. )
- Wide Unity Gain Bandwidth (  $13MHz$  typ. )
- Low Noise Voltage (  $0.9\mu V_{rms}$  typ. )
- High Output Current (  $60mA$  typ. )
- Package Outline DIP8, DMP8, SIP8
- Bipolar Technology

### ■ PACKAGE OUTLINE

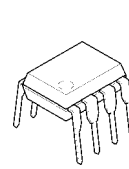

NJM2114D

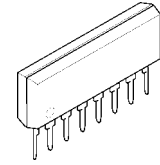

NJM2114L



NJM2114M

### ■ PIN CONFIGURATION

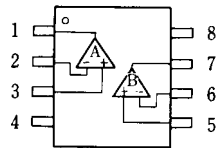

NJM2114D  
NJM2114M

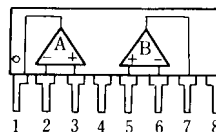

NJM2114L

### PIN FUNCTION

- 1.A OUTPUT
- 2.A -INPUT
- 3.A +INPUT
- 4.V<sup>-</sup>
- 5.B +INPUT
- 6.B -INPUT
- 7.B OUTPUT
- 8.V<sup>+</sup>

### ■ EQUIVALENT CIRCUIT

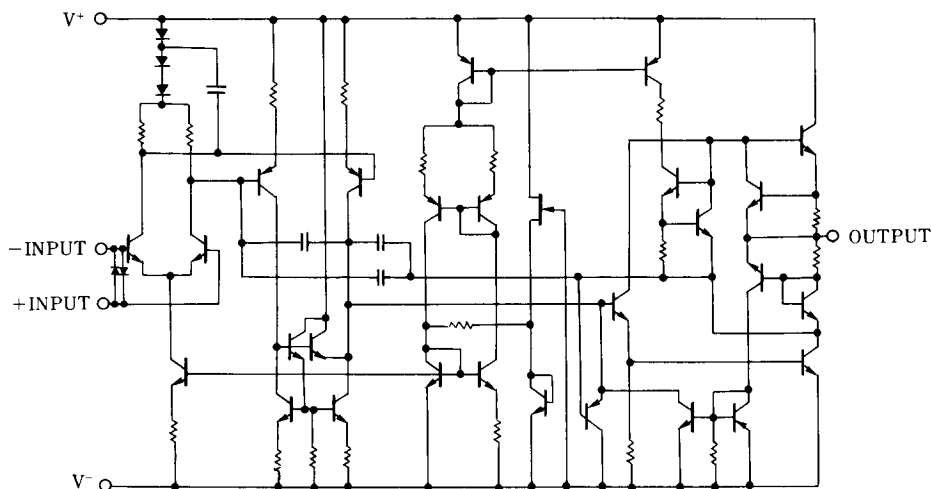

# NJM2114

## ■ ABSOLUTE MAXIMUM RATINGS

( Ta=25°C )

PARAMETER	SYMBOL	RATINGS	UNIT
Supply Voltage	$V^+ / V^-$	$\pm 22$	V
Input Voltage	$V_{IC}$	$V^+ / V^-$	V
Differential Input Voltage	$V_{ID}$	$\pm 0.5$	V
Power Dissipation	$P_D$	( DIP8 ) 800 ( SIP8 ) 800 ( DMP8 ) 600 ( note )	mW
Operating Temperature Range	$T_{opr}$	-20~+75	°C
Storage Temperature Range	$T_{stg}$	-40~+125	°C

( note ) At on PC board

## ■ ELECTRICAL CHARACTERISTICS

Direct Current Characteristics

(  $V^+ / V^- = \pm 15V, Ta = 25^\circ C$  )

PARAMETER	SYMBOL	TEST CONDITION	MIN.	TYP.	MAX.	UNIT
Operating Current	$I_{CC}$		-	9	16	mA
Input Offset Voltage	$V_{IO}$		-	0.2	3	mV
Input Offset Current	$I_{IO}$		-	0.01	0.3	uA
Input Bias Current	$I_B$		-	0.5	1.8	uA
Common Mode Input Voltage Range	$V_{ICM}$		$\pm 12$	$\pm 13$	-	V
Common Mode Rejection Ratio	CMR	$V_{ICM} = 12V$	70	100	-	dB
Supply Voltage Rejection Ratio	SVR	$V^+ / V^- = \pm 22 \rightarrow \pm 11V$	80	100	-	dB
Large Swing Voltage Gain 1	$A_{V1}$	$R_L \geq 2k\Omega, V_O = \pm 10V$	88	110	-	dB
Large Swing Voltage Gain 2	$A_{V2}$	$R_L \geq 600\Omega, V_O = \pm 10V$	83	104	-	dB
Maximum Output Voltage 1	$V_{OM1}$	$R_L \geq 600\Omega$	$\pm 12$	+14/-13	-	V
Maximum Output Voltage 2	$V_{OM2}$	$R_L \geq 600\Omega, V^+ / V^- = \pm 18V$	$\pm 15$	+17/-16	-	V
Input Resistance	$R_{IN}$		-	100	-	k $\Omega$
Output Current	$I_O$		-	60	-	mA
Slew Rate	SR	$G_V = 20dB, R_L = 2k\Omega$	-	15	-	V/ $\mu s$
Gain Bandwidth product	GB		-	13	-	MHz
Equivalent Input Noise Voltage	$V_{NI}$	20Hz~20kHz	-	0.9	-	$\mu V_{rms}$
Equivalent Input Noise Voltage	$e_N$	$f_o = 30Hz$	-	5.5	-	nV/ $\sqrt{Hz}$
Equivalent Input Noise Voltage	$e_N$	$f_o = 1kHz$	-	3.3	-	nV/ $\sqrt{Hz}$
Equivalent Input Noise Current	$I_{NI}$	$f_o = 30Hz$	-	1.5	-	pA/ $\sqrt{Hz}$
Equivalent Input Noise Current	$I_{NI}$	$f_o = 1kHz$	-	0.4	-	pA/ $\sqrt{Hz}$
Total Harmonic Distortion	THD	$f = 1kHz, V_O = 5V$	-	0.0005	-	%

## ■ NOTE

In the application as a voltage follower, there might be the case the inputs are damaged especially the moment the supply voltage is switched on.

That's why we recommend you to put the current limiting resistor at the input pin.

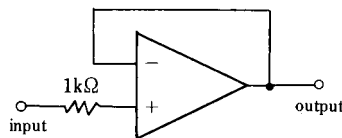

## ■ TYPICAL CHARACTERISTICS

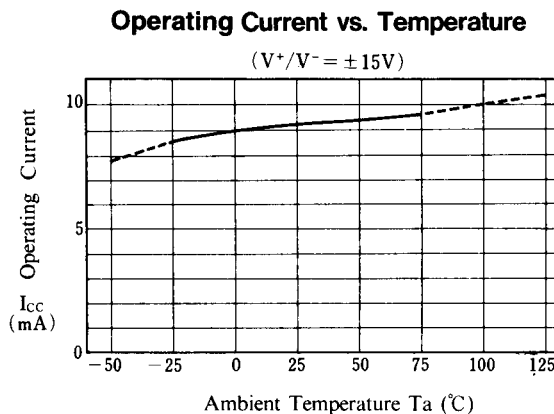
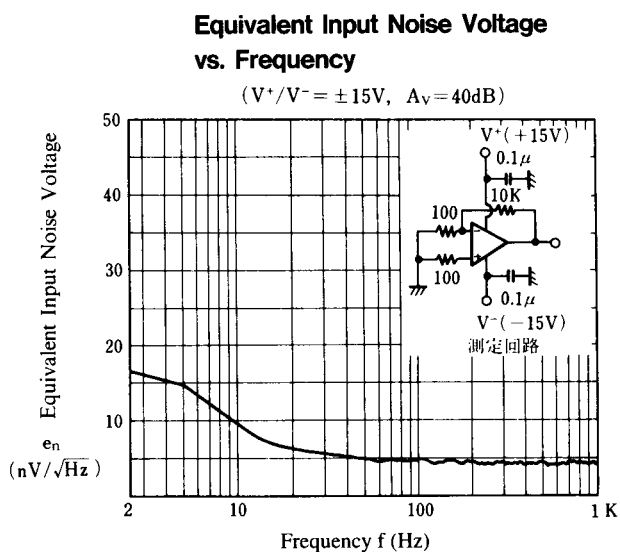
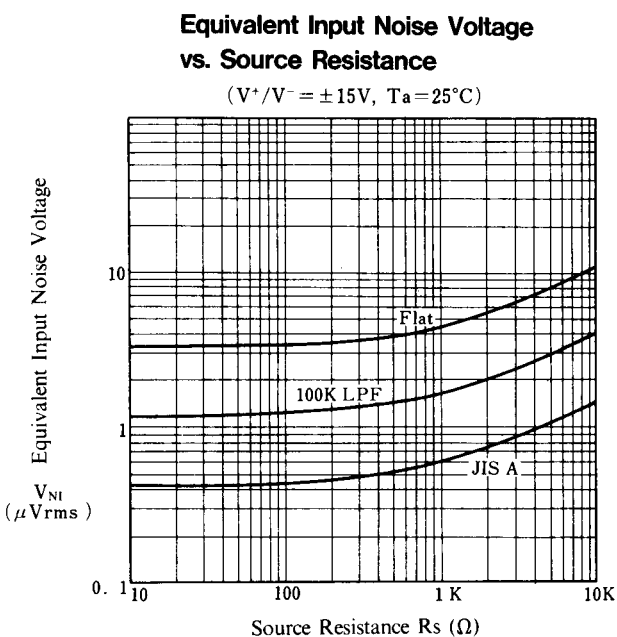
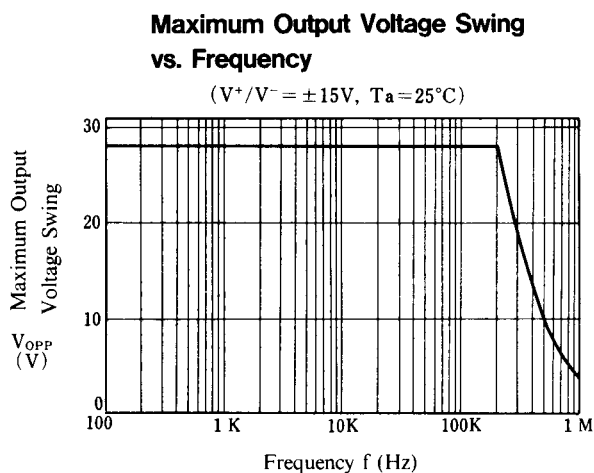
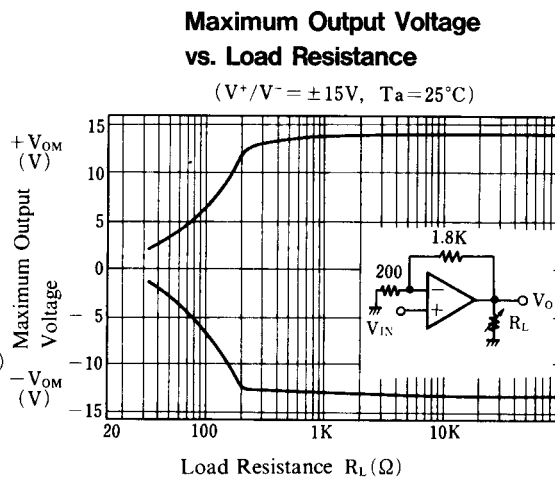
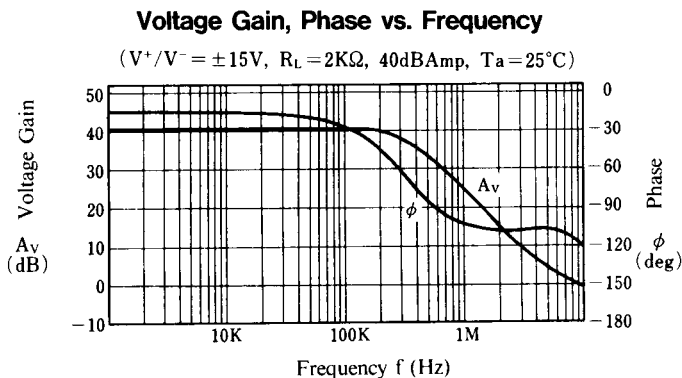

## ■ TYPICAL CHARACTERISTICS

**Input Offset Voltage vs. Temperature**

( $V^+/V^- = \pm 15V$ )

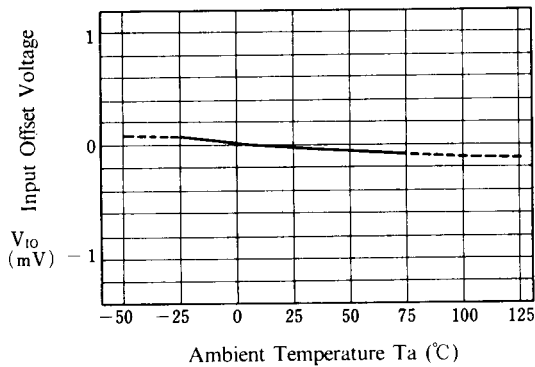

**Input Bias Current vs. Temperature**

( $V^+/V^- = \pm 15V$ )

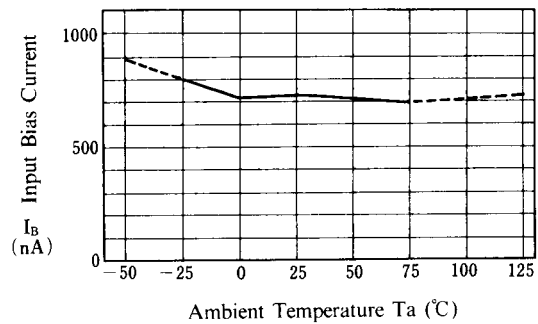

**Maximum Output Voltage vs. Operating Voltage**

( $R_L = 600\Omega, T_a = 25^\circ C$ )

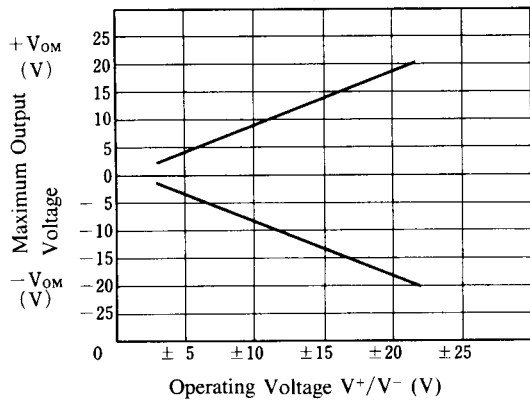

**Total Harmonic distortion vs. Output Voltage**

( $V^+/V^- = \pm 15V, R_L = 10k\Omega, \text{Gain} = 20dB, T_a = 25^\circ C$ )

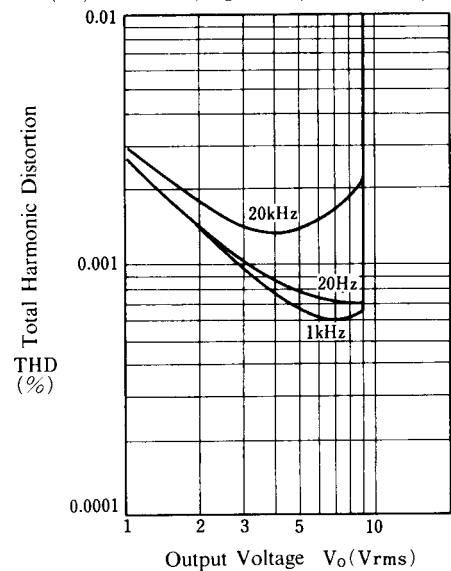

**Operating Current vs. Operating Voltage**

( $T_a = 25^\circ C$ )

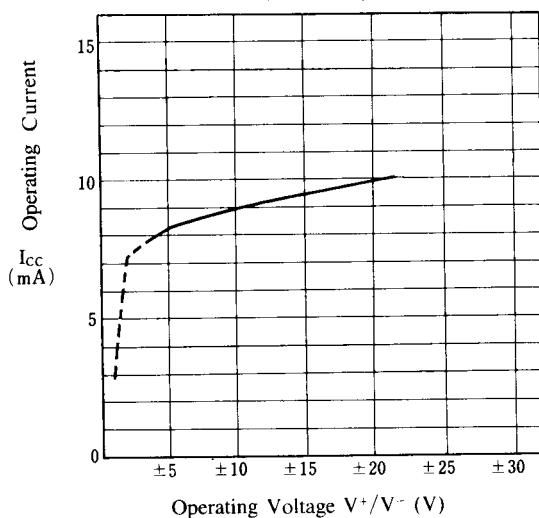

**[CAUTION]**

The specifications on this databook are only given for information, without any guarantee as regards either mistakes or omissions. The application circuits in this databook are described only to show representative usages of the product and not intended for the guarantee or permission of any right including the industrial rights.