

Low $V_{CE(sat)}$

2SA1567

Silicon PNP Epitaxial Planar Transistor (Complement to type 2SC4064)

Application : DC Motor Driver, Chopper Regulator and General Purpose

■ Absolute maximum ratings (Ta=25°C)

Symbol	Ratings	Unit
V_{CBO}	-50	V
V_{CEO}	-50	V
V_{EBO}	-6	V
I_C	-12	A
I_B	-3	A
P_C	35(Tc=25°C)	W
T_J	150	°C
T_{stg}	-55 to +150	°C

■ Electrical Characteristics (Ta=25°C)

Symbol	Conditions	Ratings	Unit
I_{CBO}	$V_{CB}=-50V$	-100max	μA
I_{EBO}	$V_{EB}=-6V$	-100max	μA
$V_{(BR)CEO}$	$I_C=-25mA$	-50min	V
h_{FE}	$V_{CE}=-1V, I_C=-6A$	50min	
$V_{CE(sat)}$	$I_C=-6A, I_B=-0.3A$	-0.35max	V
f_r	$V_{CE}=-12V, I_E=0.5A$	40typ	MHz
COB	$V_{CB}=-10V, f=1MHz$	330typ	pF

■ Typical Switching Characteristics (Common Emitter)

V_{CC} (V)	R_L (Ω)	I_C (A)	V_{BB1} (V)	V_{BB2} (V)	I_{B1} (mA)	I_{B2} (mA)	t_{on} (μs)	t_{stg} (μs)	t_f (μs)
-24	4	-6	-10	5	-120	120	0.4typ	0.4typ	0.2typ

External Dimensions FM20 (TO220F)

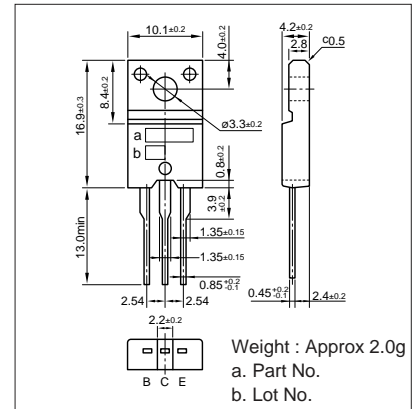

I_C-V_{CE} Characteristics (Typical)

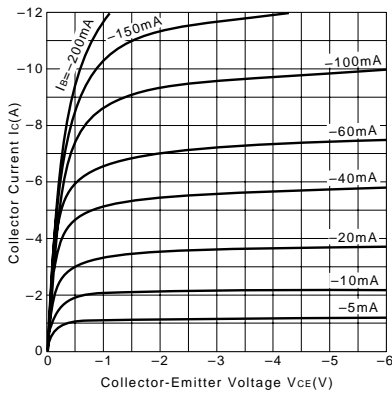

$V_{CE(sat)}-I_B$ Characteristics (Typical)

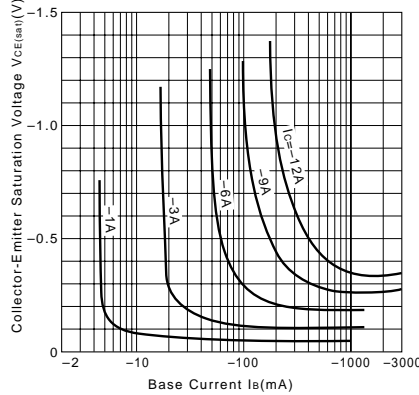

I_C-V_{BE} Temperature Characteristics (Typical)

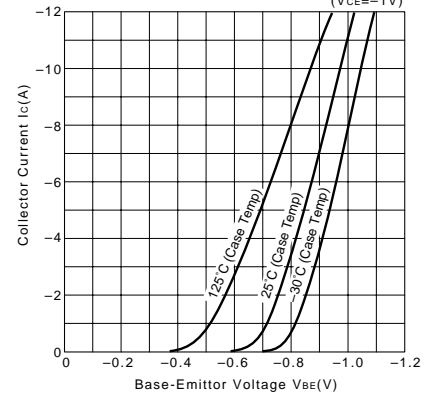

$h_{FE}-I_C$ Characteristics (Typical)

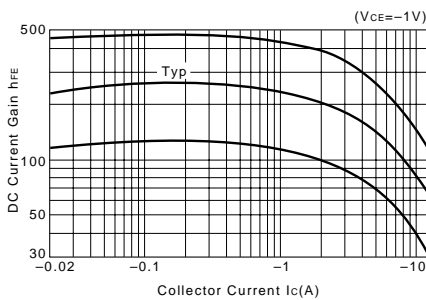

$h_{FE}-I_C$ Temperature Characteristics (Typical)

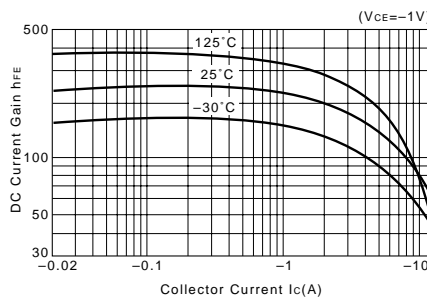

$\theta_{j-a}-t$ Characteristics

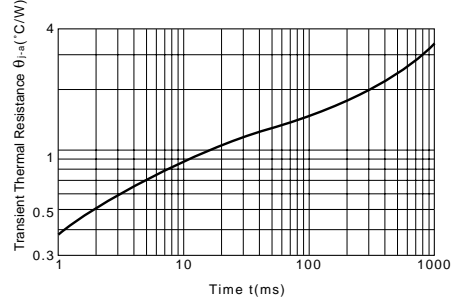

f_T-I_E Characteristics (Typical)

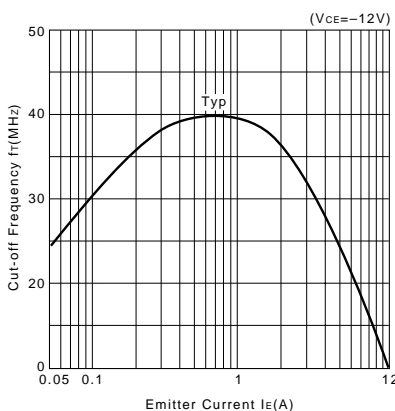

Safe Operating Area (Single Pulse)

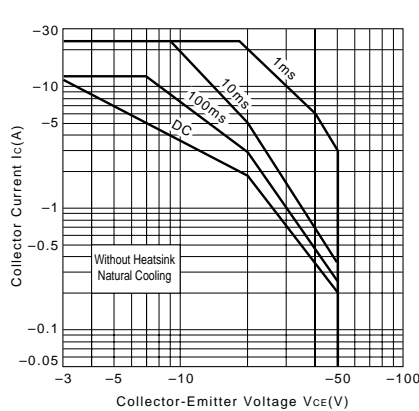

P_C-T_a Derating

