

1

2

3

4

5

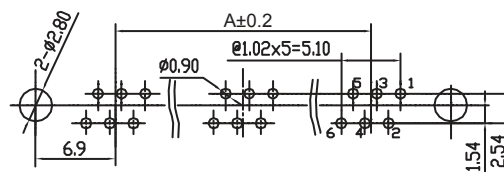

PCB LAYOUT - COMPONENT VIEW

TECHNICAL CHARACTERISTICS

MATERIAL
 INSULATOR: PBT
 FLAMMABILITY RATING: UL94-V0
 COLOR: BLACK
 CONTACT MATERIAL: COPPER ALLOY
 CONTACT TYPE: STAMPED CONTACT
 PLATING: GOLD
 METAL PIN: BRASS NI PLATED
 QUALITY CLASS: 500 MATING CYLCES

ENVIRONMENTAL
 OPERATING TEMPERATURE: -40°C UP TO +85°C
 COMPLIANCE: LEAD FREE AND ROHS

ELECTRICAL
 CURRENT RATING: 1.5 A
 WORKING VOLTAGE: 120 VAC
 INSULATION RESISTANCE: >500 MΩ
 WITHSTANDING VOLTAGE: 1000 VAC/min
 CONTACT RESISTANCE: 20 mΩ max

STANDARD
 RoHS CERTIFIED: E324776

SOLDERING
 JEDEC LEAD FREE WAVE SOLDERING PROCESS

PACKAGING
 TRAY

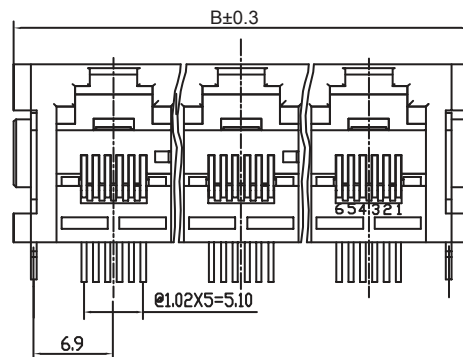
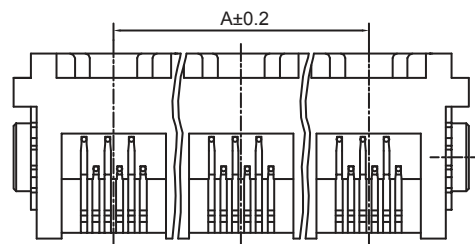
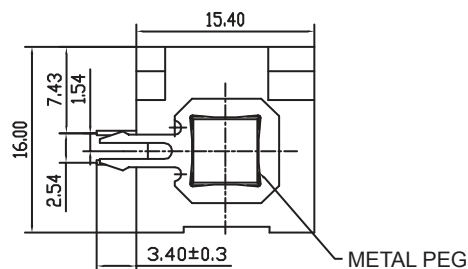

size	ports		
	2	3	4
xx	12	18	24
A	11.00	22.00	33.00
B	28.20	39.20	50.20

RoHS Compliant

PROJECTION:



GENERAL TOLERANCE

.X = +/- 0.3

.XX = +/- 0.20



APPROVAL: JTs

UNIT: MM

SCALE:

SHEET: 1/3

DRAW: AS

DESCRIPTION: HORIZONTAL PLASTIC 6P6C
 ASSEMBLY MODULAR JACK TAB UP

WERI PART NO: 615 0xx 149 421

SIZE

A4

REV	DATE	FILE	BY
G			
F			
E			
D			
C			
B	10-SEP-15	ADDITION TABLE	AK
A	23-JUL-14	PDF	AS

1

2

3

4

5

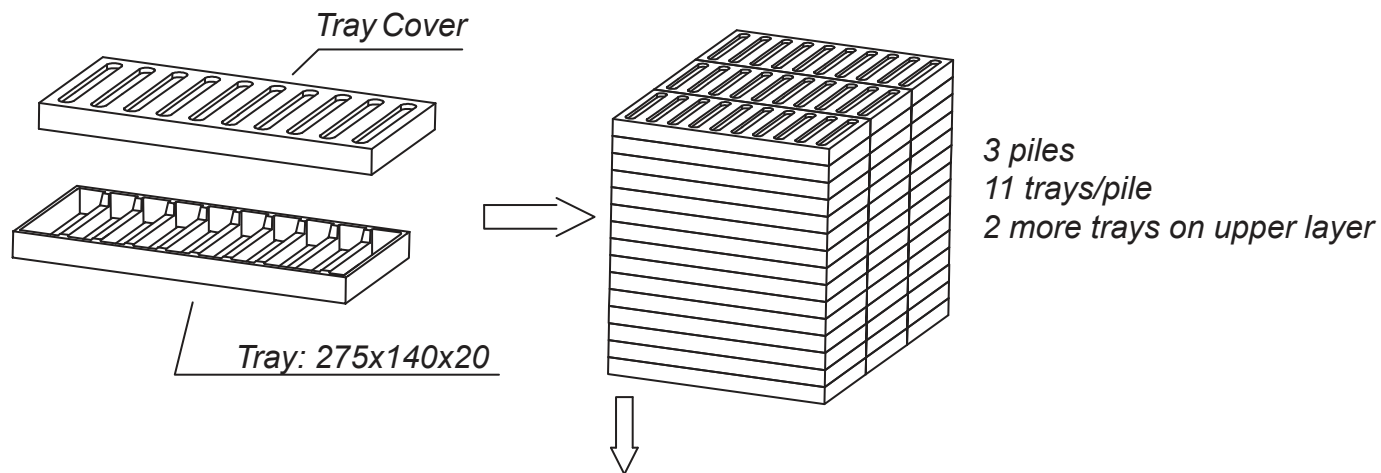

Carton size: 460x310x310
Waterproof bag size: 450x350x570

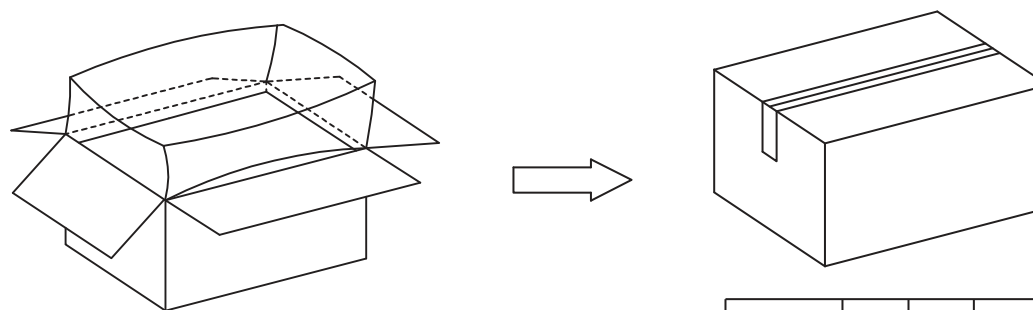

Ports	2	3	4
Pcs/Tray	40	30	20
Pcs/Carton	1400	1050	700

RoHS Compliant

G			
F			
E			
D			
C			
B			
A	23-JUL-14	PDF	AS
REV	DATE	FILE	BY

PROJECTION:



APPROVAL: JTs

GENERAL TOLERANCE

.X = +/- 0.2

.XX = +/- 0.15



UNIT: MM

SCALE:

SHEET: 2/3

DRAW: AS

DESCRIPTION: HORIZONTAL PLASTIC 6P6C
ASSEMBLY MODULAR JACK TAB UP

WERI PART NO: 615 0xx 149 421

SIZE

A4

1

2

3

4

5

Cautions and Warnings:

This electronic component is designed and developed with the intention for use in general electronics equipments.



Before incorporating the components into any equipments in the field such as aerospace, aviation, nuclear control, submarine, transportation, (automotive control, train control, ship control), transportation signal, disaster prevention, medical, public information network etc. where higher safety and reliability are especially required or if there is possibility of direct damage or injury to human body, Würth Elektronik must be asked for a written approval.

In addition, even electronic component in general electronic equipments, when used in electrical circuits that require high safety, reliability functions or performance, the sufficient reliability evaluation-check for the safety must be performed before by the user before usage.

A

B

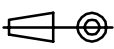
C

RoHS Compliant				PROJECTION: 	GENERAL TOLERANCE .X = +/- 0.2 .XX = +/- 0.15	 WÜRTH ELEKTRONIK	DESCRIPTION: DISCLAIMER	SIZE A4
G								
F								
E								
D								
C				APPROVAL: JC	UNIT: MM	WERI PART NO: DISCLAIMER	SIZE A4	
B					SCALE:			
A	10-SEP-14	PDF	QL		SHEET: 3/3			
REV	DATE	FILE	BY		DRAW: QL			

D