

# μPD5750T7D

## SiGe BiCMOS Integrated Circuit Wide Band LNA IC with Through Function

R09DS0009EJ0100

Rev.1.00

Feb 24, 2011

### DESCRIPTION

The μPD5750T7D is a low noise wideband amplifier IC mainly designed for the portable digital TV application. This IC exhibits low noise figure and high power gain characteristics. The μPD5750T7D has an LNA pass-through function (bypass function) to prevent the degradation of the received signal quality at the strong electric field, and achieve the high reception sensitivity and low power consumption.

The package is a 6-pin WLBGA (Wafer Level Ball Grid Array) (T7D) suitable for surface mount.

This IC is manufactured using our latest SiGe BiCMOS process that shows superior high frequency characteristics.

### FEATURES

- Low voltage operation :  $V_{CC} = 1.8 \text{ V TYP.}$
- Low mode control voltage :  $V_{\text{cont(H)}} = 1.0 \text{ V to } V_{CC}, V_{\text{cont(L)}} = 0 \text{ to } 0.4 \text{ V}$
- Low current consumption :  $I_{CC} = 3.1 \text{ mA TYP. @ } V_{CC} = 1.8 \text{ V (LNA-mode)}$   
:  $I_{CC} = 1 \mu\text{A MAX. @ } V_{CC} = 1.8 \text{ V (Bypass-mode)}$
- Low noise :  $\text{NF} = 1.5 \text{ dB TYP. @ } V_{CC} = 1.8 \text{ V, } f = 470 \text{ MHz}$   
(LNA-mode) :  $\text{NF} = 1.4 \text{ dB TYP. @ } V_{CC} = 1.8 \text{ V, } f = 770 \text{ MHz}$
- High gain :  $G_p = 13.5 \text{ dB TYP. @ } V_{CC} = 1.8 \text{ V, } f = 470 \text{ MHz}$   
(LNA-mode) :  $G_p = 12.5 \text{ dB TYP. @ } V_{CC} = 1.8 \text{ V, } f = 770 \text{ MHz}$
- Low insertion loss :  $L_{\text{ins}} = 1.2 \text{ dB TYP. @ } V_{CC} = 1.8 \text{ V, } f = 470 \text{ MHz}$   
(Bypass-mode) :  $L_{\text{ins}} = 1.4 \text{ dB TYP. @ } V_{CC} = 1.8 \text{ V, } f = 770 \text{ MHz}$
- High-density surface mounting : 6-pin WLBGA (0.73 × 0.48 × 0.26 mm)
- Included protection circuit for ESD

### APPLICATIONS

- Low noise amplifier for the portable and mobile digital TV system, etc.

### ORDERING INFORMATION

Part Number	Order Number	Package	Marking	Supplying Form
μPD5750T7D-E4A	μPD5750T7D-E4A-A	6-pin WLBGA (T7D) (Pb-Free)	A	<ul style="list-style-type: none"> <li>• Embossed tape 8 mm wide</li> <li>• Pin A3, B3 face the perforation side of the tape</li> <li>• Qty 10 kpcs/reel</li> </ul>

**Remark** To order evaluation samples, please contact your nearby sales office.

Part number for sample order: μPD5750T7D

### CAUTION

Observe precautions when handling because these devices are sensitive to electrostatic discharge.

## PIN CONNECTIONS AND MARKING

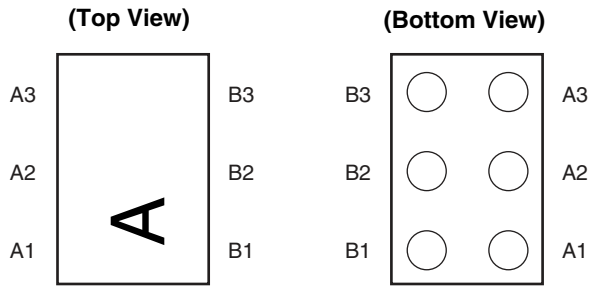

Pin No	Pin Name
A1	INPUT
A2	GND1
A3	OUTPUT
B1	V <sub>cont</sub>
B2	GND2
B3	V <sub>CC</sub>

## INTERNAL BLOCK DIAGRAM

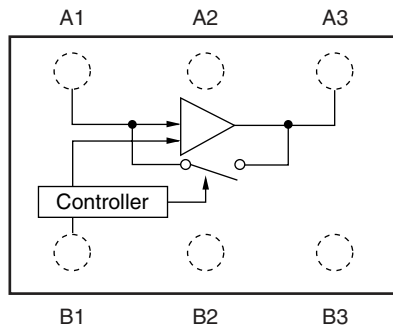

## TRUTH TABLE

V <sub>cont</sub>	Gain	Mode
H	High	LNA-mode
L	Low	Bypass-mode

Remark "H" = V<sub>cont</sub> (H), "L" = V<sub>cont</sub> (L)

## ABSOLUTE MAXIMUM RATINGS (T<sub>A</sub> = +25°C, unless otherwise specified)

Parameter	Symbol	Ratings	Unit
Supply Voltage	V <sub>CC</sub>	3.6	V
Mode Control Voltage	V <sub>cont</sub>	3.6	V
Operating Ambient Temperature	T <sub>A</sub>	-40 to +85	°C
Storage Temperature	T <sub>stg</sub>	-55 to +150	°C
Input Power	P <sub>in</sub>	+30	dBm

## RECOMMENDED OPERATING RANGE (T<sub>A</sub> = +25°C, unless otherwise specified)

Parameter	Symbol	MIN.	TYP.	MAX.	Unit
Supply Voltage	V <sub>CC</sub>	1.6	1.8	2.0	V
Mode Control Voltage (H)	V <sub>cont</sub> (H)	1.0	—	V <sub>CC</sub>	V
Mode Control Voltage (L)	V <sub>cont</sub> (L)	0	—	0.4	V
Operating Frequency	f	50	—	1 800	MHz
Operating Ambient Temperature	T <sub>A</sub>	-40	—	+85	°C
Input Power (LNA-mode)	P <sub>in</sub>	—	—	+7	dBm
Input Power (Bypass-mode)	P <sub>in</sub>	—	—	+15	dBm

**ELECTRICAL CHARACTERISTICS 1 (DC Characteristics)**  
( $T_A = +25^{\circ}\text{C}$ ,  $V_{CC} = 1.8\text{ V}$ , unless otherwise specified)

Parameter	Symbol	Test Conditions	MIN.	TYP.	MAX.	Unit
Circuit Current 1	$I_{CC1}$	$V_{cont} = 1.8\text{ V}$ , No Signal (LNA-mode)	1.6	3.1	4.5	mA
Circuit Current 2	$I_{CC2}$	$V_{cont} = 0\text{ V}$ , No Signal (Bypass-mode)	–	–	1	μA
Mode Control Current 1	$I_{cont1}$	$V_{cont} = 1.8\text{ V}$ , No Signal (LNA-mode)	–	20	30	μA
Mode Control Current 2	$I_{cont2}$	$V_{cont} = 0\text{ V}$ , No Signal (Bypass-mode)	–	–	1	μA

**ELECTRICAL CHARACTERISTICS 2 (LNA-mode)**  
( $T_A = +25^{\circ}\text{C}$ ,  $V_{CC} = V_{cont} = 1.8\text{ V}$ ,  $Z_S = Z_L = 50\ \Omega$ , unless otherwise specified)

Parameter	Symbol	Test Conditions	MIN.	TYP.	MAX.	Unit
Power Gain 1	$G_{P1}$	$f = 470\text{ MHz}$ , $P_{in} = -30\text{ dBm}$ , excluded PCB and connector losses <b>Note 1</b>	10.5	13.5	16.5	dB
Power Gain 2	$G_{P2}$	$f = 770\text{ MHz}$ , $P_{in} = -30\text{ dBm}$ , excluded PCB and connector losses <b>Note 1</b>	9.5	12.5	15.5	dB
Noise Figure 1	NF1	$f = 470\text{ MHz}$ , excluded PCB and connector losses <b>Note 2</b>	–	1.5	2.0	dB
Noise Figure 2	NF2	$f = 770\text{ MHz}$ , excluded PCB and connector losses <b>Note 2</b>	–	1.4	2.0	dB
Output Return Loss 1	$RL_{out1}$	$f = 470\text{ MHz}$ , $P_{in} = -30\text{ dBm}$	6.5	8.5	–	dB
Output Return Loss 2	$RL_{out2}$	$f = 770\text{ MHz}$ , $P_{in} = -30\text{ dBm}$	6.0	8.0	–	dB
Input 3rd Order Intercept Point 1	$IIP_{31}$	$f1 = 470\text{ MHz}$ , $f2 = 471\text{ MHz}$ , $P_{in} = -30\text{ dBm}$	–15	–11	–	dBm
Input 3rd Order Intercept Point 2	$IIP_{32}$	$f1 = 770\text{ MHz}$ , $f2 = 771\text{ MHz}$ , $P_{in} = -30\text{ dBm}$	–12	–8	–	dBm

Notes: 1. Input-output PCB and connector losses : 0.20 dB (at 470 MHz), 0.27 dB (at 770 MHz)  
 2. Input PCB and connector losses : 0.10 dB (at 470 MHz), 0.14 dB (at 770 MHz)

**ELECTRICAL CHARACTERISTICS 3 (Bypass-mode)**  
( $T_A = +25^{\circ}\text{C}$ ,  $V_{CC} = 1.8\text{ V}$ ,  $V_{cont} = 0\text{ V}$ ,  $Z_S = Z_L = 50\ \Omega$ , unless otherwise specified)

Parameter	Symbol	Test Conditions	MIN.	TYP.	MAX.	Unit
Insertion Loss 1	$L_{ins1}$	$f = 470\text{ MHz}$ , $P_{in} = -10\text{ dBm}$ , excluded PCB and connector losses <b>Note</b>	–	1.2	2.0	dB
Insertion Loss 2	$L_{ins2}$	$f = 770\text{ MHz}$ , $P_{in} = -10\text{ dBm}$ , excluded PCB and connector losses <b>Note</b>	–	1.4	2.0	dB
Input Return Loss 1	$RL_{in1}$	$f = 470\text{ MHz}$ , $P_{in} = -10\text{ dBm}$	10	17	–	dB
Input Return Loss 2	$RL_{in2}$	$f = 770\text{ MHz}$ , $P_{in} = -10\text{ dBm}$	10	14	–	dB
Output Return Loss 1	$RL_{out1}$	$f = 470\text{ MHz}$ , $P_{in} = -10\text{ dBm}$	10	17	–	dB
Output Return Loss 2	$RL_{out2}$	$f = 770\text{ MHz}$ , $P_{in} = -10\text{ dBm}$	10	14	–	dB
Input 3rd Order Intercept Point	$IIP_3$	$f1 = 770\text{ MHz}$ , $f2 = 771\text{ MHz}$ , $P_{in} = -2.5\text{ dBm}$	+25	+32	–	dBm

Note: Input-output PCB and connector losses : 0.20 dB (at 470 MHz), 0.27 dB (at 770 MHz)

**STANDARD CHARACTERISTICS FOR REFERENCE 1 (LNA-mode)**  
 (T<sub>A</sub> = +25°C, V<sub>CC</sub> = V<sub>cont</sub> = 1.8 V, Z<sub>S</sub> = Z<sub>L</sub> = 50 Ω, unless otherwise specified)

Parameter	Symbol	Test Conditions	Reference Value	Unit
Isolation 1	ISL1	f = 470 MHz, P <sub>in</sub> = -30 dBm	-30	dB
Isolation 2	ISL2	f = 770 MHz, P <sub>in</sub> = -30 dBm	-25	dB
Input Return Loss 1	RL <sub>in1</sub>	f = 470 MHz, P <sub>in</sub> = -30 dBm	1.7	dB
Input Return Loss 2	RL <sub>in2</sub>	f = 770 MHz, P <sub>in</sub> = -30 dBm	2.5	dB
Input Impedance 1	Z <sub>in1</sub>	f = 470 MHz, P <sub>in</sub> = -30 dBm <b>Note</b>	0.50 - j 2.01	Ω
Input Impedance 2	Z <sub>in2</sub>	f = 770 MHz, P <sub>in</sub> = -30 dBm <b>Note</b>	0.36 - j 1.21	Ω
Gain 1 dB Compression Output Power 1	P <sub>O(1 dB)1</sub>	f = 470 MHz	-12	dBm
Gain 1 dB Compression Output Power 2	P <sub>O(1 dB)2</sub>	f = 770 MHz	-12	dBm

Note: Calibration reference plane : Device edge side

**STANDARD CHARACTERISTICS FOR REFERENCE 2 (Bypass-mode)**  
 (T<sub>A</sub> = +25°C, V<sub>CC</sub> = 1.8 V, V<sub>cont</sub> = 0 V, Z<sub>S</sub> = Z<sub>L</sub> = 50 Ω, unless otherwise specified)

Parameter	Symbol	Test Conditions	Reference Value	Unit
Gain 1 dB Compression Output Power	P <sub>O(1 dB)</sub>	f = 770 MHz	+6	dBm

**TEST CIRCUIT**

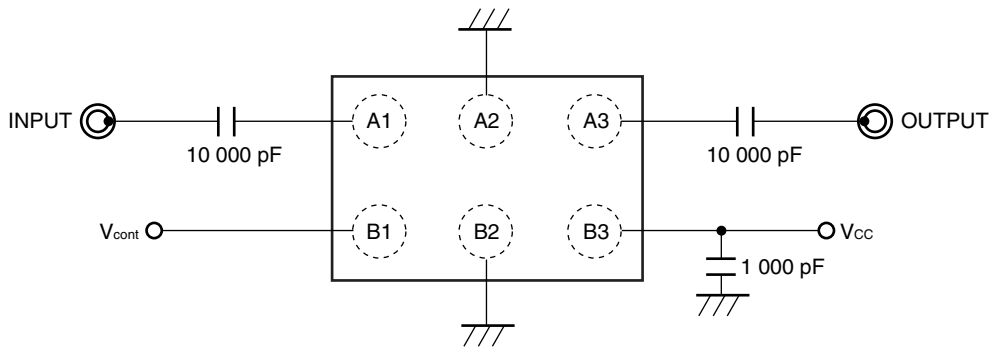

**TYPICAL CHARACTERISTICS 1 (DC Characteristics)**

( $T_A = +25^\circ\text{C}$ , unless otherwise specified)

CIRCUIT CURRENT vs. SUPPLY VOLTAGE

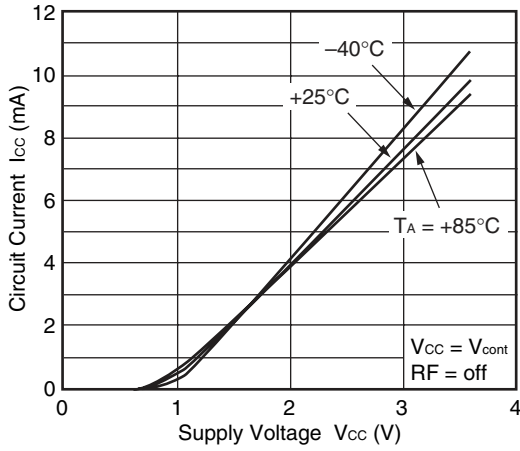

CIRCUIT CURRENT vs. OPERATING AMBIENT TEMPERATURE

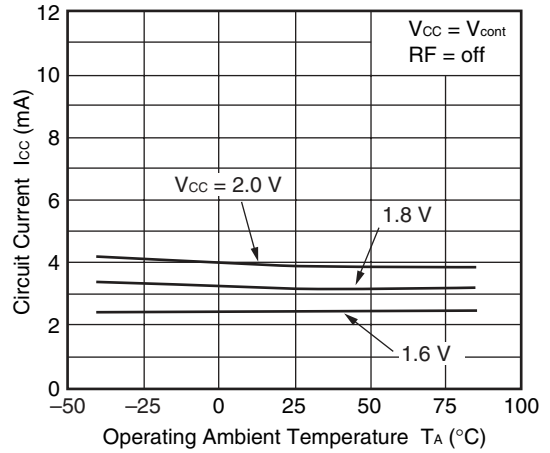

MODE CONTROL CURRENT vs. SUPPLY VOLTAGE

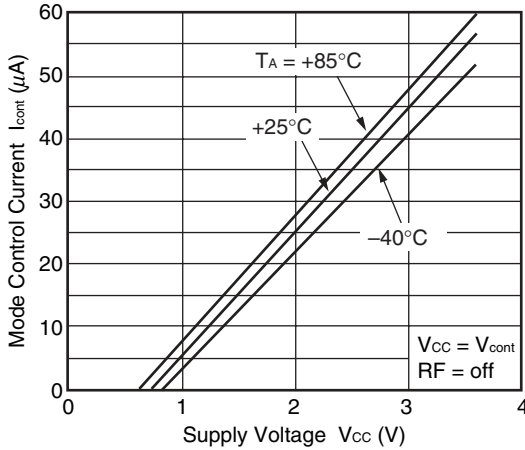

MODE CONTROL CURRENT vs. OPERATING AMBIENT TEMPERATURE

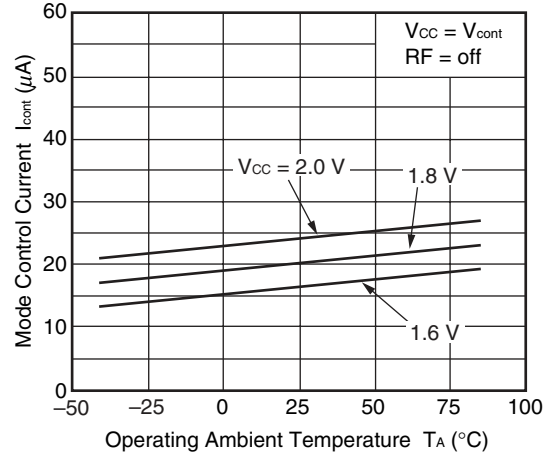

CIRCUIT CURRENT vs. MODE CONTROL VOLTAGE

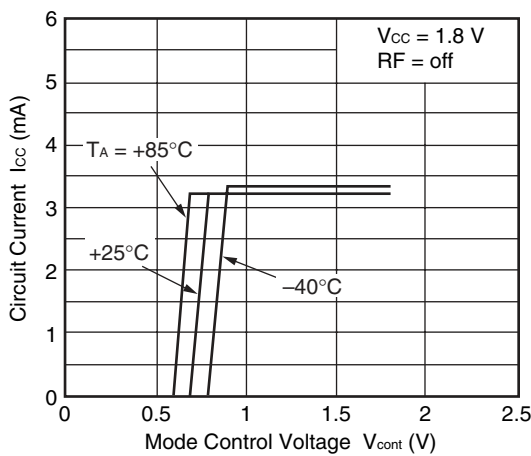

MODE CONTROL CURRENT vs. MODE CONTROL VOLTAGE

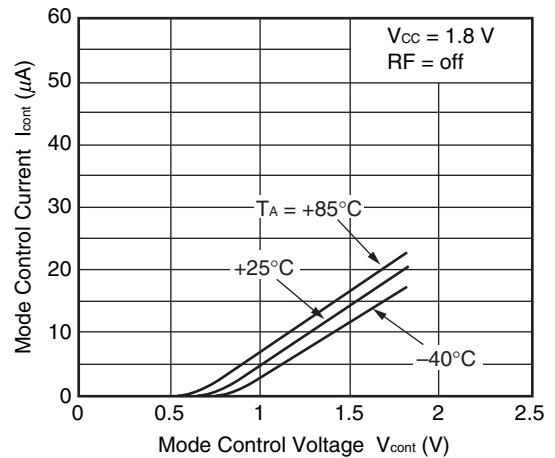

**Remark** The graphs indicate nominal characteristics.

**TYPICAL CHARACTERISTICS 2 (LNA-mode)**  
 (T<sub>A</sub> = +25°C, unless otherwise specified)

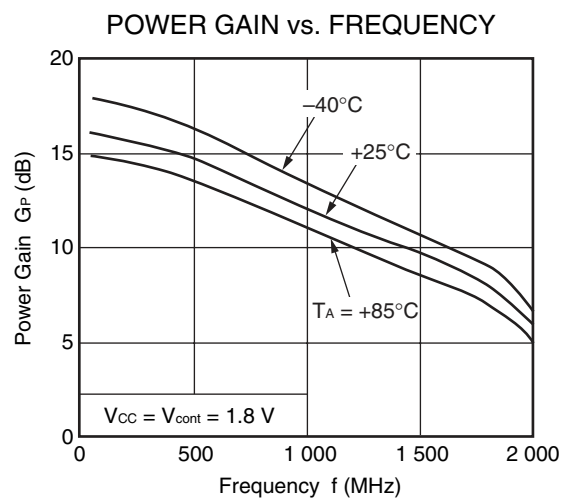
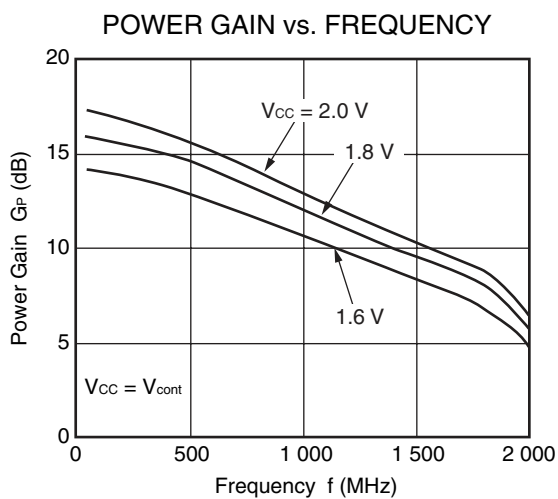
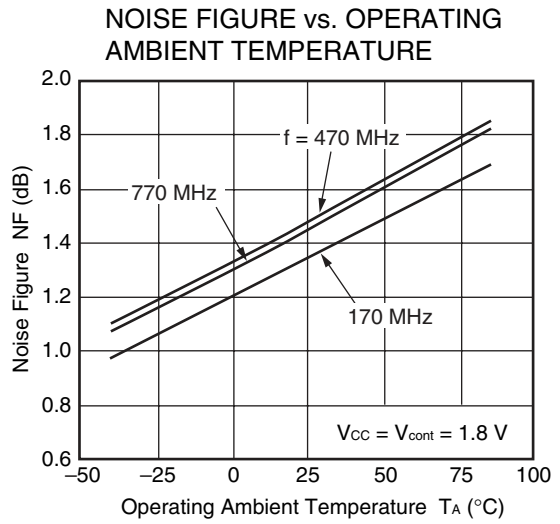
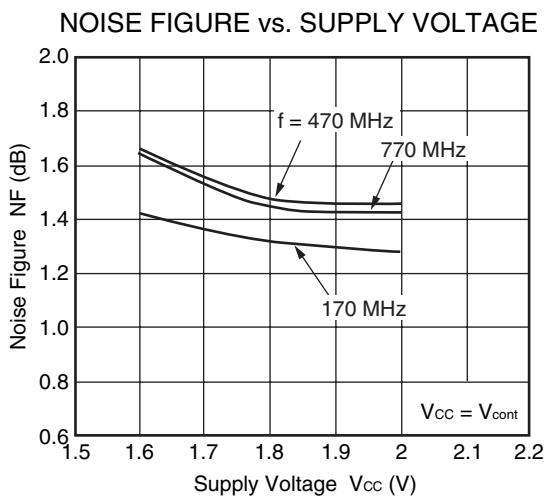
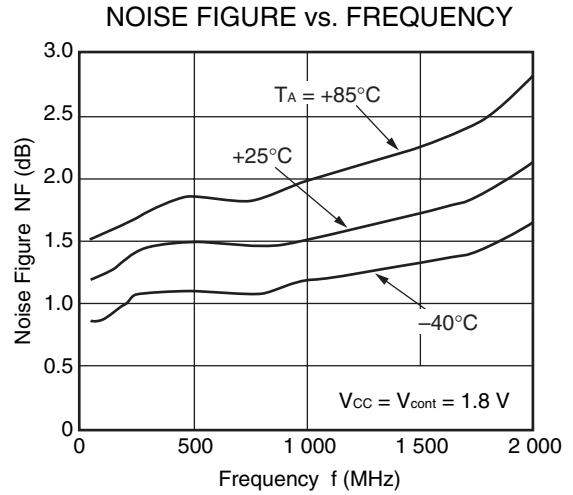
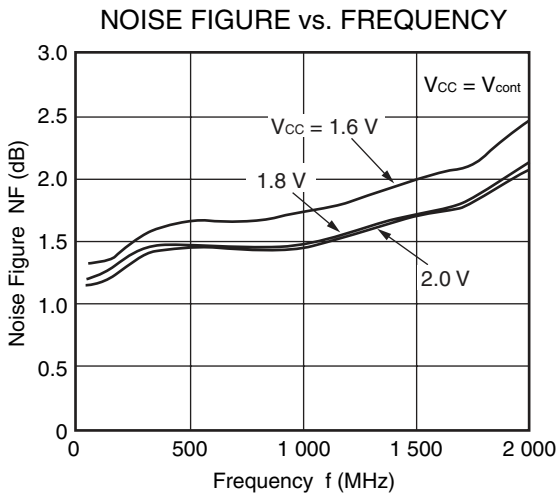

**Remark** The graphs indicate nominal characteristics.

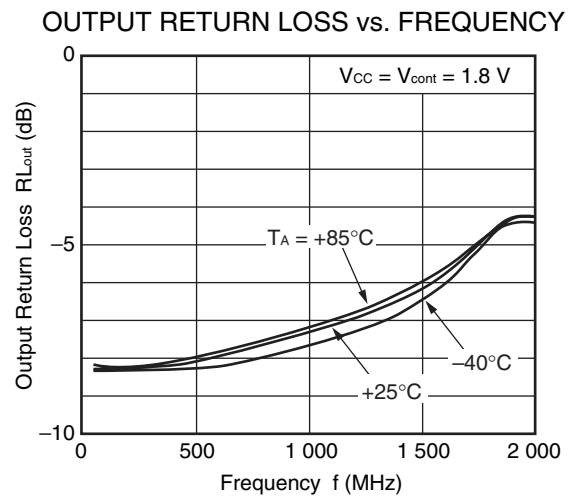
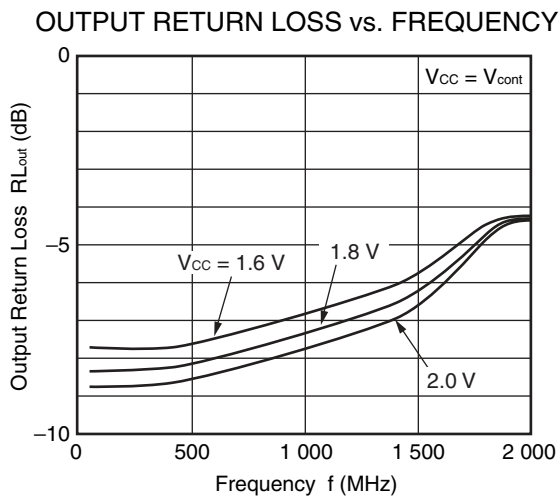
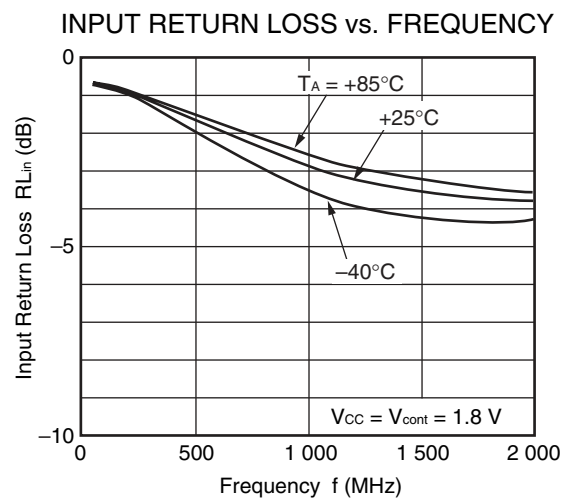
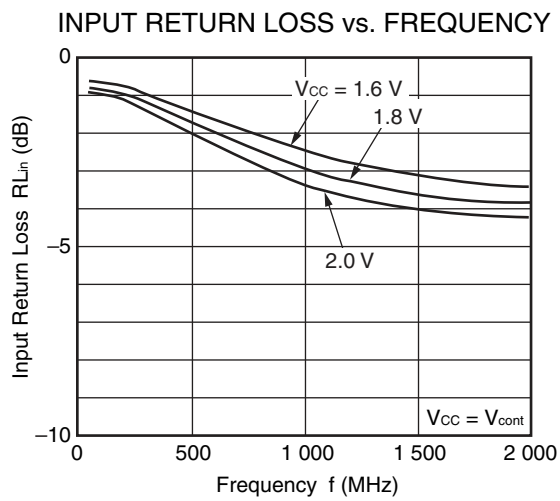
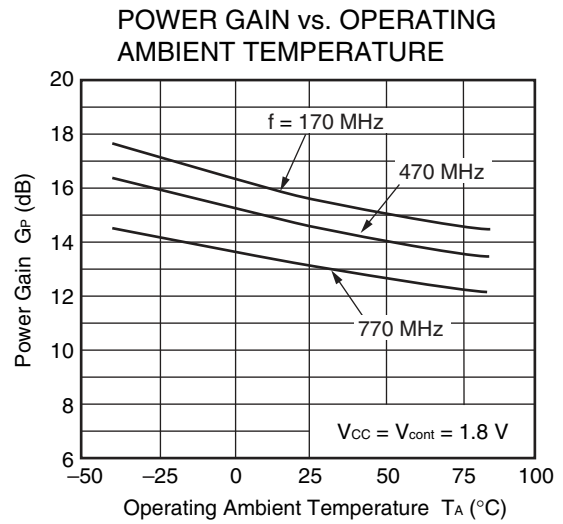
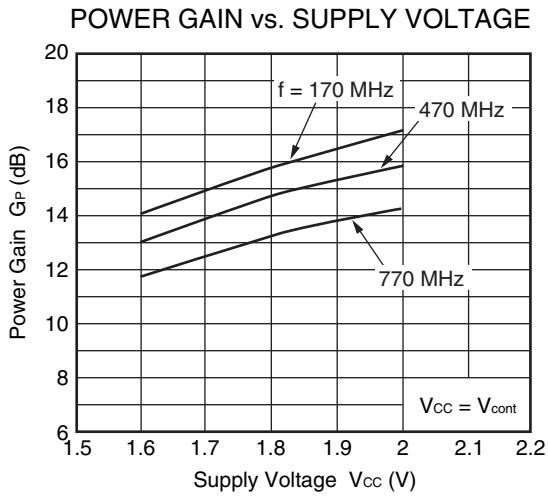

**Remark** The graphs indicate nominal characteristics.

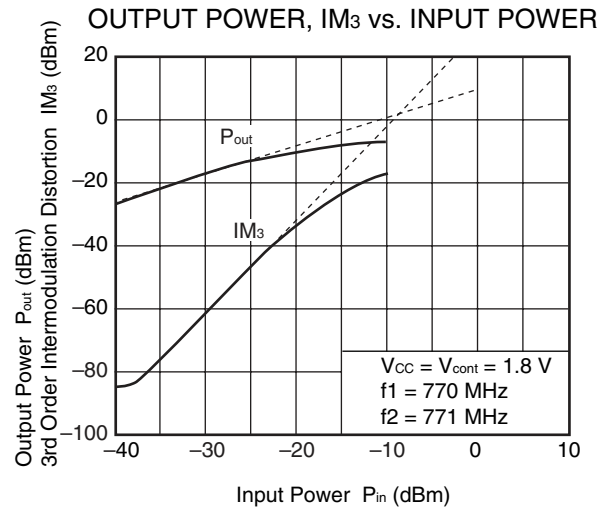
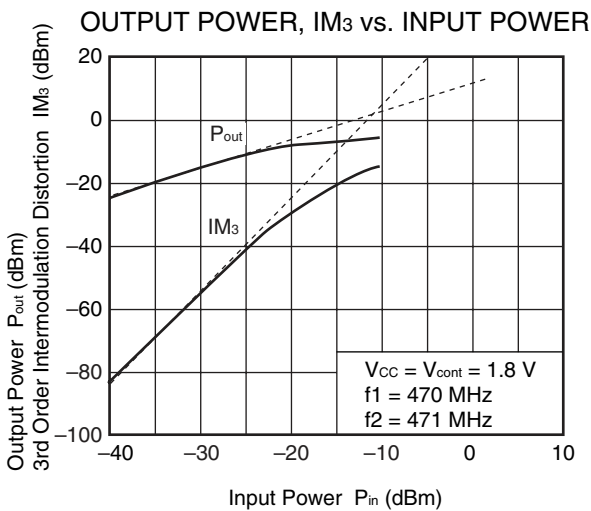
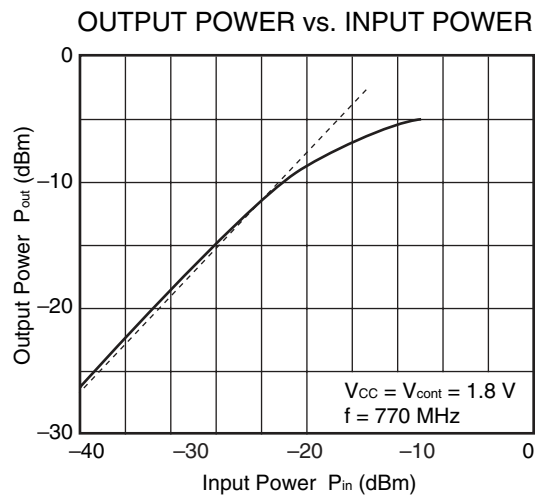
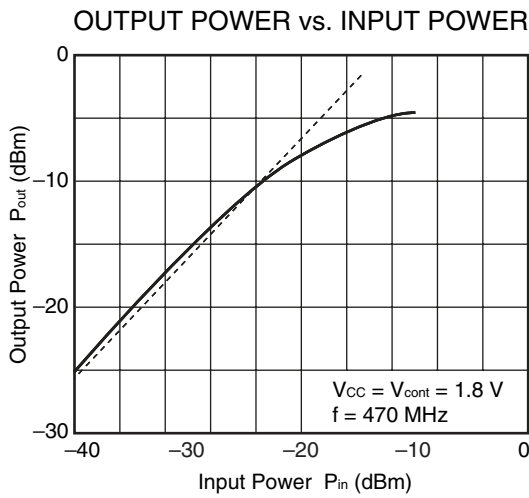
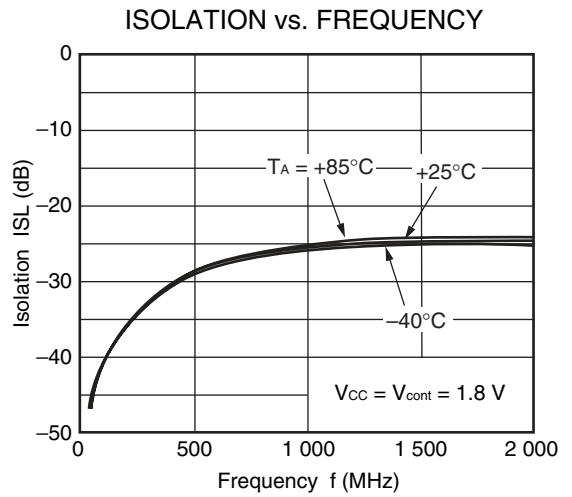
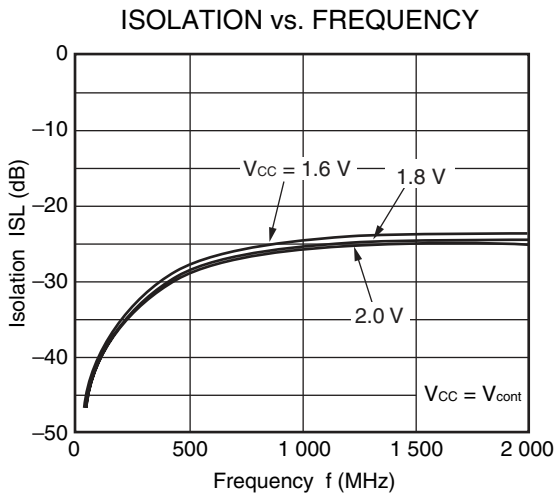

**Remark** The graphs indicate nominal characteristics.



### S-PARAMETERS 1 (LNA-mode)

( $T_A = +25^\circ\text{C}$ ,  $V_{CC} = V_{cont} = 1.8\text{ V}$ , Calibration reference plane: Device edge side)

#### S<sub>11</sub>-FREQUENCY

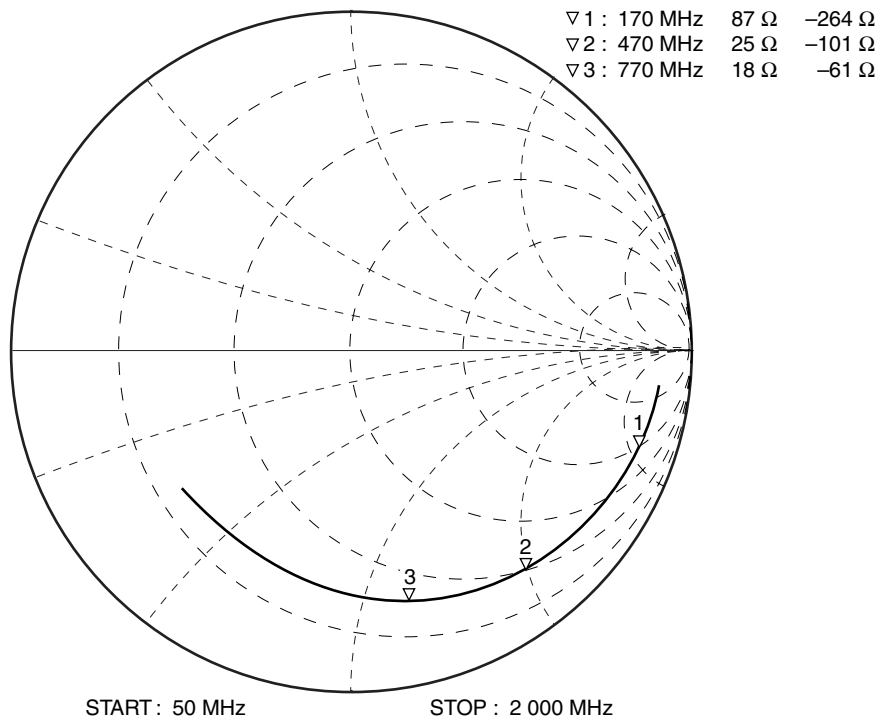

#### S<sub>22</sub>-FREQUENCY

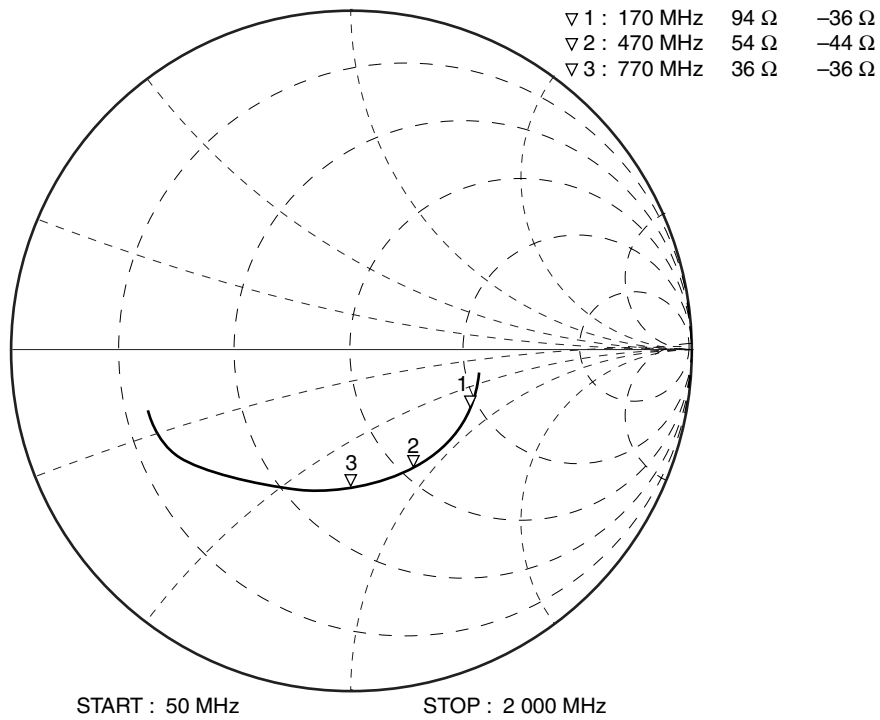

**Remark** The graphs indicate nominal characteristics.

### TYPICAL CHARACTERISTICS 3 (Bypass-mode) ( $T_A = +25^\circ\text{C}$ , unless otherwise specified)

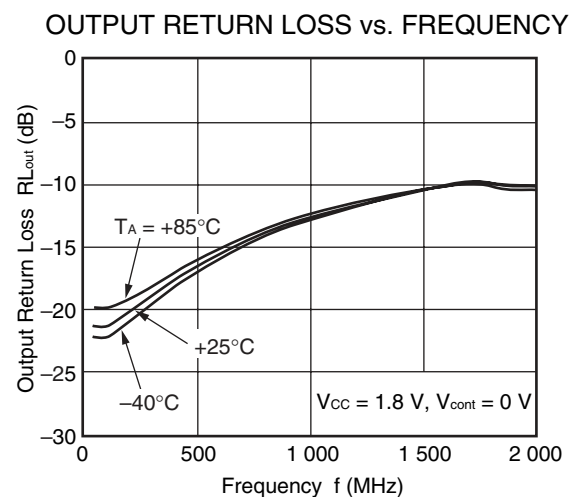
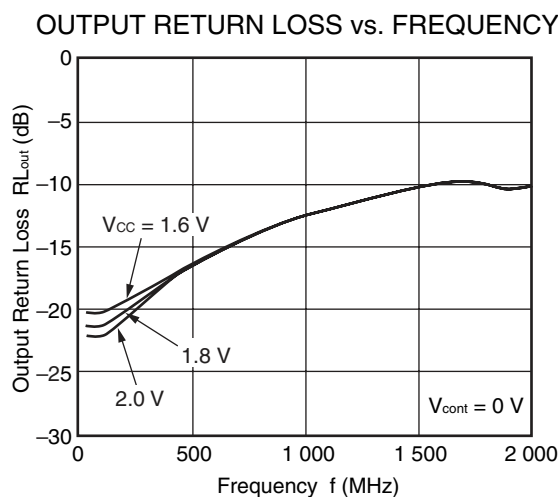
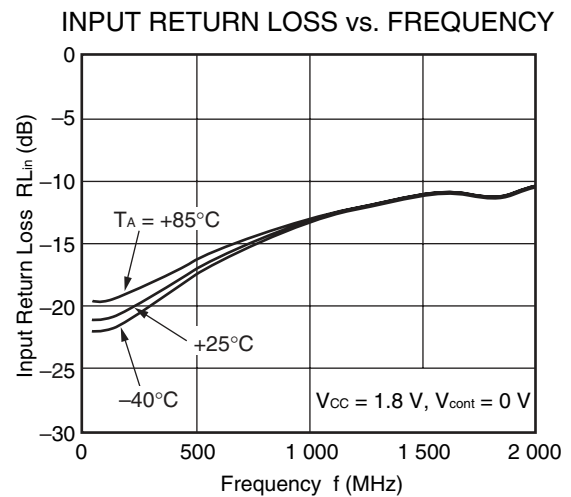
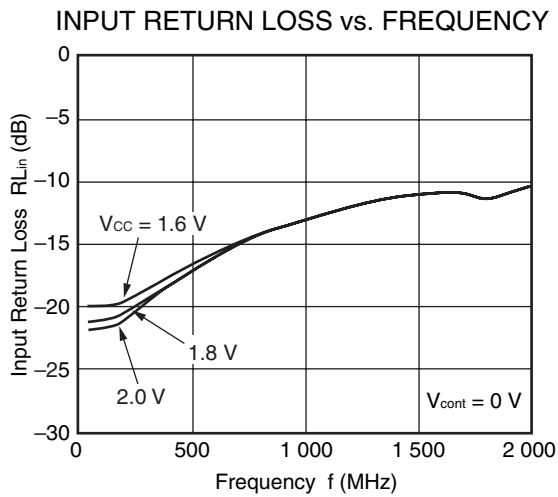
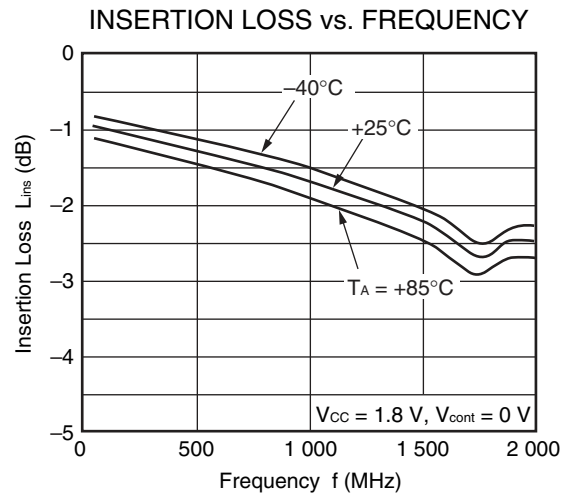
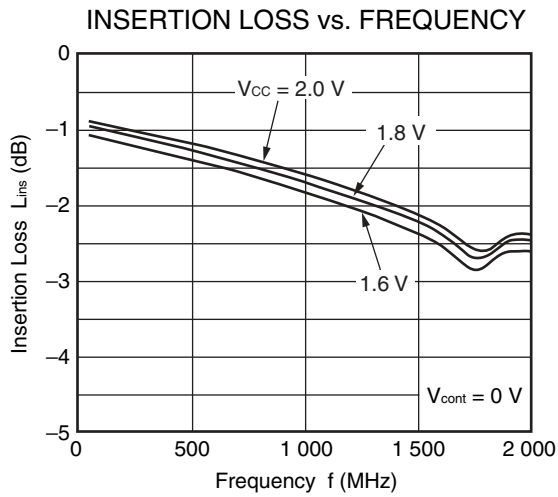

**Remark** The graphs indicate nominal characteristics.

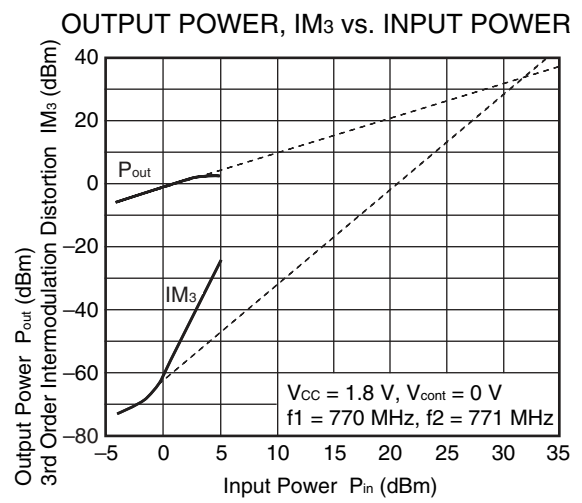
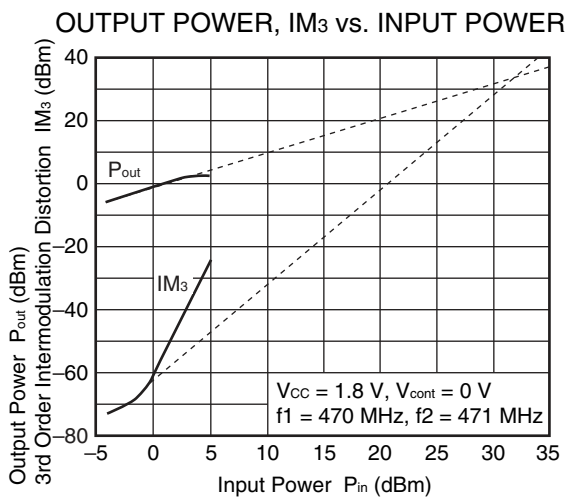
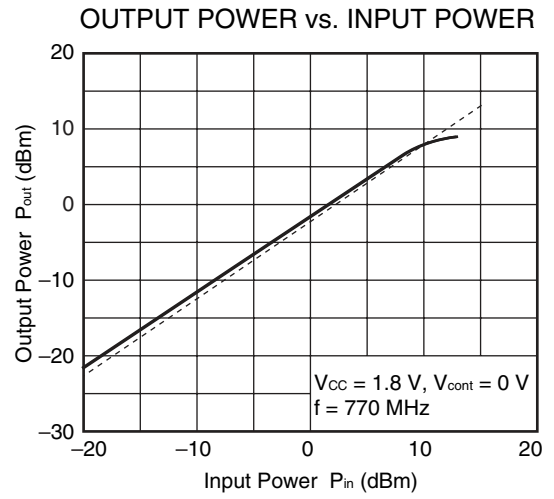
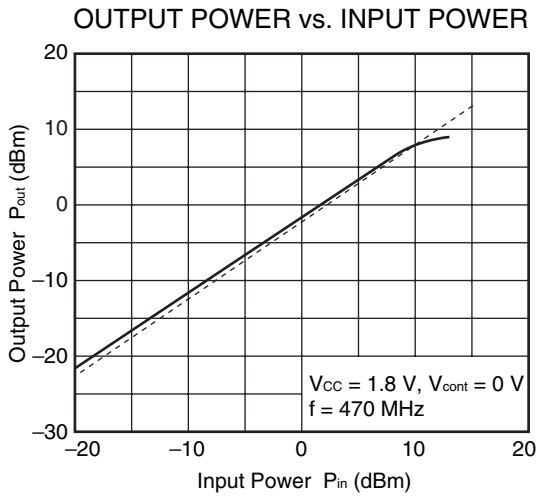

**Remark** The graphs indicate nominal characteristics.

### S-PARAMETERS 2 (Bypass-mode)

( $T_A = +25^\circ\text{C}$ ,  $V_{CC} = 1.8\text{ V}$ ,  $V_{cont} = 0\text{ V}$ , Calibration reference plane: Device edge side)

#### S<sub>11</sub>-FREQUENCY

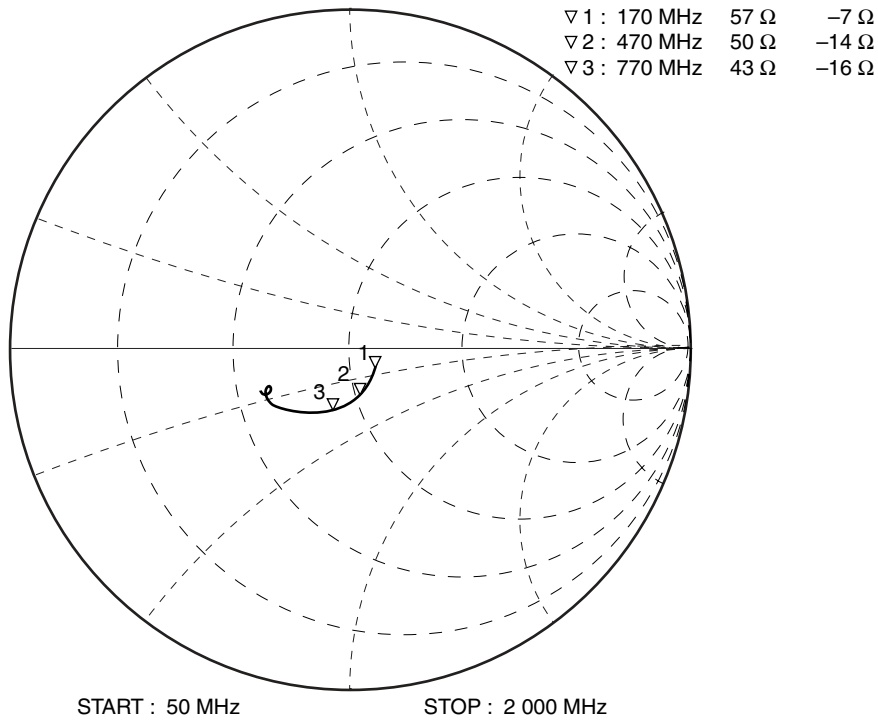

#### S<sub>22</sub>-FREQUENCY

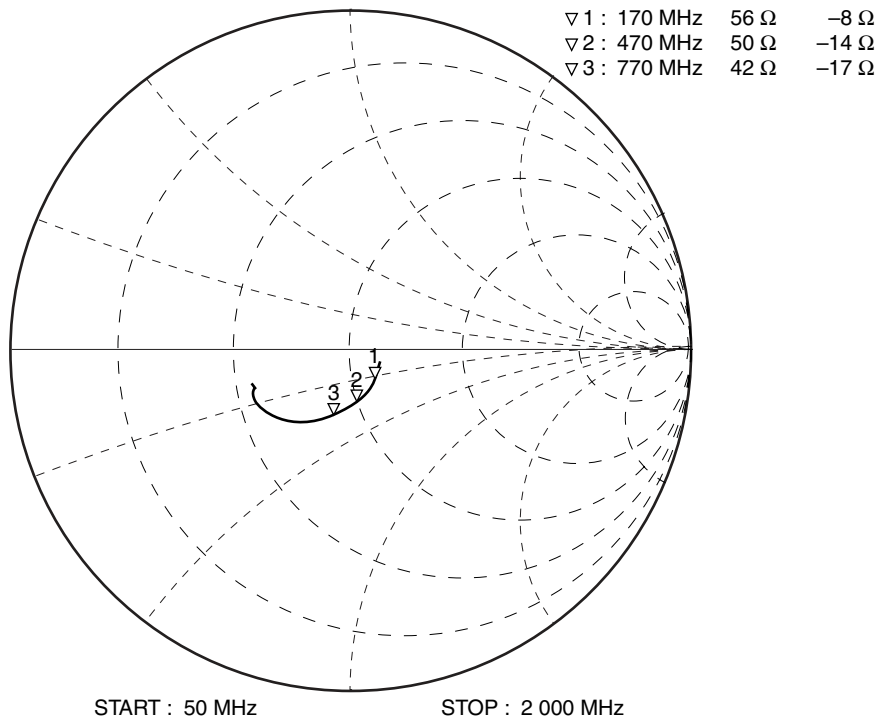

**Remark** The graphs indicate nominal characteristics.

# PACKAGE DIMENSIONS

6-PIN WLBGA (T7D) (UNIT: mm)

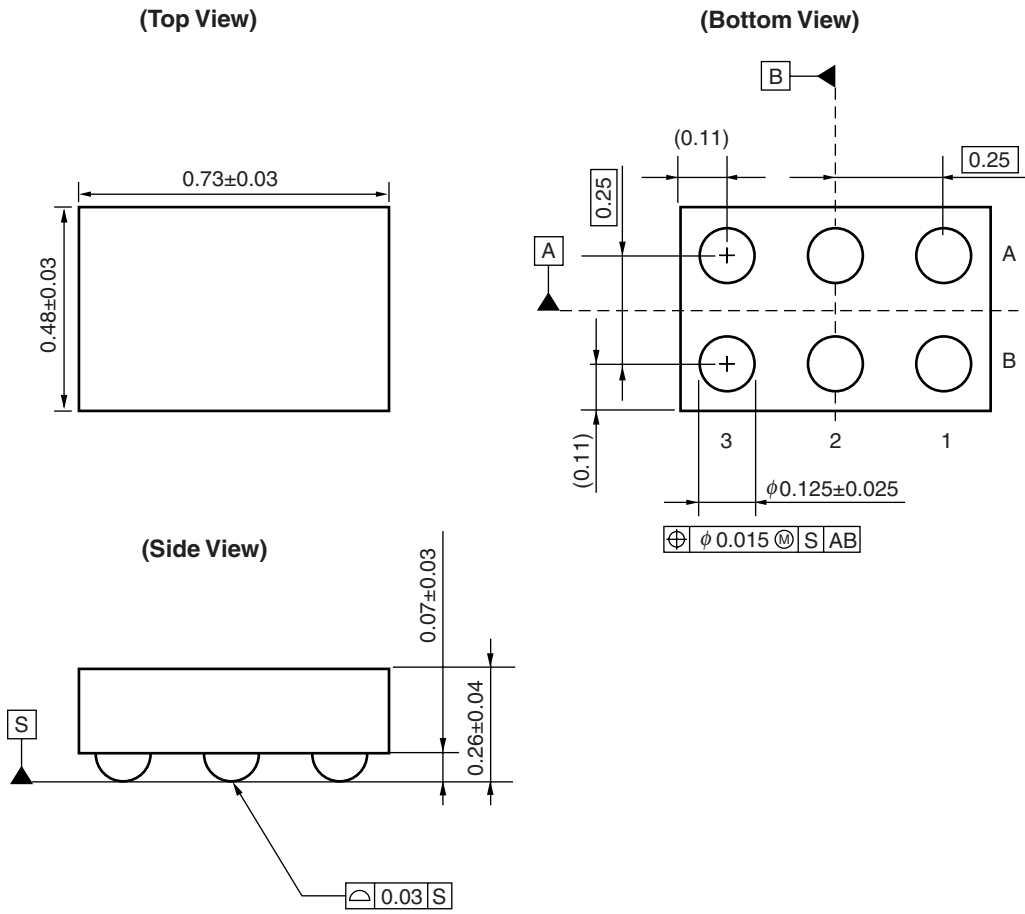

Remark ( ): Reference value

### NOTES ON CORRECT USE

- (1) Observe precautions for handling because of electro-static sensitive devices.
- (2) Form a ground pattern as widely as possible to minimize ground impedance (to prevent undesired oscillation).  
All the ground terminals must be connected together with wide ground pattern to decrease impedance difference.
- (3) The bypass capacitor should be attached to V<sub>CC</sub> line.
- (4) Do not supply DC voltage to INPUT pin.

### RECOMMENDED SOLDERING CONDITIONS

This product should be soldered and mounted under the following recommended conditions. For soldering methods and conditions other than those recommended below, contact your nearby sales office.

Soldering Method	Soldering Conditions	Condition Symbol
Infrared Reflow	Peak temperature (package surface temperature) : 260°C or below Time at peak temperature : 10 seconds or less Time at temperature of 220°C or higher : 60 seconds or less Preheating time at 120 to 180°C : 120±30 seconds Maximum number of reflow processes : 3 times Maximum chlorine content of rosin flux (% mass) : 0.2%(Wt.) or below	IR260

#### CAUTION

Do not use different soldering methods together.

<b>Revision History</b>	<b><math>\mu</math>PD5750T7D Data Sheet</b>
-------------------------	---

<b>Rev.</b>	<b>Date</b>	<b>Description</b>	
		<b>Page</b>	<b>Summary</b>
1.00	Feb 24, 2011	—	First edition issued

All trademarks and registered trademarks are the property of their respective owners.

## Notice

- All information included in this document is current as of the date this document is issued. Such information, however, is subject to change without any prior notice. Before purchasing or using any Renesas Electronics products listed herein, please confirm the latest product information with a Renesas Electronics sales office. Also, please pay regular and careful attention to additional and different information to be disclosed by Renesas Electronics such as that disclosed through our website.
  - Renesas Electronics does not assume any liability for infringement of patents, copyrights, or other intellectual property rights of third parties by or arising from the use of Renesas Electronics products or technical information described in this document. No license, express, implied or otherwise, is granted hereby under any patents, copyrights or other intellectual property rights of Renesas Electronics or others.
  - You should not alter, modify, copy, or otherwise misappropriate any Renesas Electronics product, whether in whole or in part.
  - Descriptions of circuits, software and other related information in this document are provided only to illustrate the operation of semiconductor products and application examples. You are fully responsible for the incorporation of these circuits, software, and information in the design of your equipment. Renesas Electronics assumes no responsibility for any losses incurred by you or third parties arising from the use of these circuits, software, or information.
  - When exporting the products or technology described in this document, you should comply with the applicable export control laws and regulations and follow the procedures required by such laws and regulations. You should not use Renesas Electronics products or the technology described in this document for any purpose relating to military applications or use by the military, including but not limited to the development of weapons of mass destruction. Renesas Electronics products and technology may not be used for or incorporated into any products or systems whose manufacture, use, or sale is prohibited under any applicable domestic or foreign laws or regulations.
  - Renesas Electronics has used reasonable care in preparing the information included in this document, but Renesas Electronics does not warrant that such information is error free. Renesas Electronics assumes no liability whatsoever for any damages incurred by you resulting from errors in or omissions from the information included herein.
  - Renesas Electronics products are classified according to the following three quality grades: "Standard", "High Quality", and "Specific". The recommended applications for each Renesas Electronics product depends on the product's quality grade, as indicated below. You must check the quality grade of each Renesas Electronics product before using it in a particular application. You may not use any Renesas Electronics product for any application categorized as "Specific" without the prior written consent of Renesas Electronics. Further, you may not use any Renesas Electronics product for any application for which it is not intended without the prior written consent of Renesas Electronics. Renesas Electronics shall not be in any way liable for any damages or losses incurred by you or third parties arising from the use of any Renesas Electronics product for an application categorized as "Specific" or for which the product is not intended where you have failed to obtain the prior written consent of Renesas Electronics. The quality grade of each Renesas Electronics product is "Standard" unless otherwise expressly specified in a Renesas Electronics data sheets or data books, etc.  
"Standard": Computers; office equipment; communications equipment; test and measurement equipment; audio and visual equipment; home electronic appliances; machine tools; personal electronic equipment; and industrial robots.  
"High Quality": Transportation equipment (automobiles, trains, ships, etc.); traffic control systems; anti-disaster systems; anti-crime systems; safety equipment; and medical equipment not specifically designed for life support.  
"Specific": Aircraft; aerospace equipment; submersible repeaters; nuclear reactor control systems; medical equipment or systems for life support (e.g. artificial life support devices or systems), surgical implantations, or healthcare intervention (e.g. excision, etc.), and any other applications or purposes that pose a direct threat to human life.
  - You should use the Renesas Electronics products described in this document within the range specified by Renesas Electronics, especially with respect to the maximum rating, operating supply voltage range, movement power voltage range, heat radiation characteristics, installation and other product characteristics. Renesas Electronics shall have no liability for malfunctions or damages arising out of the use of Renesas Electronics products beyond such specified ranges.
  - Although Renesas Electronics endeavors to improve the quality and reliability of its products, semiconductor products have specific characteristics such as the occurrence of failure at a certain rate and malfunctions under certain use conditions. Further, Renesas Electronics products are not subject to radiation resistance design. Please be sure to implement safety measures to guard them against the possibility of physical injury, and injury or damage caused by fire in the event of the failure of a Renesas Electronics product, such as safety design for hardware and software including but not limited to redundancy, fire control and malfunction prevention, appropriate treatment for aging degradation or any other appropriate measures. Because the evaluation of microcomputer software alone is very difficult, please evaluate the safety of the final products or system manufactured by you.
  - Please contact a Renesas Electronics sales office for details as to environmental matters such as the environmental compatibility of each Renesas Electronics product. Please use Renesas Electronics products in compliance with all applicable laws and regulations that regulate the inclusion or use of controlled substances, including without limitation, the EU RoHS Directive. Renesas Electronics assumes no liability for damages or losses occurring as a result of your noncompliance with applicable laws and regulations.
  - This document may not be reproduced or duplicated, in any form, in whole or in part, without prior written consent of Renesas Electronics.
  - Please contact a Renesas Electronics sales office if you have any questions regarding the information contained in this document or Renesas Electronics products, or if you have any other inquiries.
- (Note 1) "Renesas Electronics" as used in this document means Renesas Electronics Corporation and also includes its majority-owned subsidiaries.  
(Note 2) "Renesas Electronics product(s)" means any product developed or manufactured by or for Renesas Electronics.



### SALES OFFICES

Renesas Electronics Corporation

<http://www.renesas.com>

Refer to "<http://www.renesas.com/>" for the latest and detailed information.

**Renesas Electronics America Inc.**  
2880 Scott Boulevard Santa Clara, CA 95050-2554, U.S.A.  
Tel: +1-408-586-6000, Fax: +1-408-586-6130

**Renesas Electronics Canada Limited**  
1101 Nicholson Road, Newmarket, Ontario L3Y 9C3, Canada  
Tel: +1-905-898-5441, Fax: +1-905-898-3220

**Renesas Electronics Europe Limited**  
Dukes Meadow, Millboard Road, Bourne End, Buckinghamshire, SL8 5FH, U.K.  
Tel: +44-1628-585-100, Fax: +44-1628-585-900

**Renesas Electronics Europe GmbH**  
Arcadiastrasse 10, 40472 Düsseldorf, Germany  
Tel: +49-211-65030, Fax: +49-211-6503-1327

**Renesas Electronics (China) Co., Ltd.**  
7th Floor, Quantum Plaza, No.27 ZhiChunLu Haidian District, Beijing 100083, P.R.China  
Tel: +86-10-8235-1155, Fax: +86-10-8235-7679

**Renesas Electronics (Shanghai) Co., Ltd.**  
Unit 204, 205, AZIA Center, No.1233 Lujiazui Ring Rd., Pudong District, Shanghai 200120, China  
Tel: +86-21-5877-1818, Fax: +86-21-6887-7858 / -7898

**Renesas Electronics Hong Kong Limited**  
Unit 1601-1613, 16/F., Tower 2, Grand Century Place, 193 Prince Edward Road West, Mongkok, Kowloon, Hong Kong  
Tel: +852-2886-9318, Fax: +852 2886-9022/9044

**Renesas Electronics Taiwan Co., Ltd.**  
7F, No. 363 Fu Shing North Road Taipei, Taiwan  
Tel: +886-2-8175-9600, Fax: +886 2-8175-9670

**Renesas Electronics Singapore Pte. Ltd.**  
1 HarbourFront Avenue, #06-10, Keppel Bay Tower, Singapore 098632  
Tel: +65-6213-0200, Fax: +65-6276-8001

**Renesas Electronics Malaysia Sdn.Bhd.**  
Unit 906, Block B, Menara Amcorp, Amcorp Trade Centre, No. 18, Jin Persiaran Barat, 46050 Petaling Jaya, Selangor Darul Ehsan, Malaysia  
Tel: +60-3-7955-9390, Fax: +60-3-7955-9510

**Renesas Electronics Korea Co., Ltd.**  
11F., Samik Lavied' or Bldg., 720-2 Yeoksam-Dong, Kangnam-Ku, Seoul 135-080, Korea  
Tel: +82-2-558-3737, Fax: +82-2-558-5141