

124D

TUBE DRIVER - INTERSTAGE TRANSFORMER

This transformer operates in the 150 Hz to 15 KHz range.
 Designed for general purpose or replacement use in single ended
 or phase inverter tube driver circuits
 Open style, 2 point mount with minimum 5" long leads
 Core material Grain Oriented Silicone Steel laminations

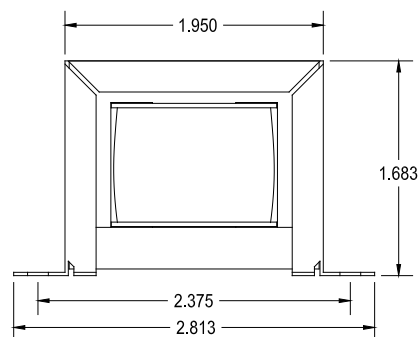
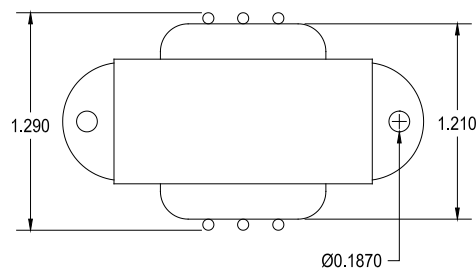

ELECTRICAL SPECIFICATIONS

Characteristic	Typical
Input Impedance	7,000 ΩCT
Output Impedance	15,800 ΩCT
Output Power	5.0 Watts
DCR	
Primary	
BLU – RED	218 Ω
RED – BRN	236 Ω
Secondary	
GRN – BLK	297 Ω
BLK – GRN	394 Ω
Inductance	@ 1.0 kHz, 1.0 V OC
Primary	6.45 H
Secondary	14.4 H
Leakage Inductance	0.125 H
Impedance	@ 1.0 kHz, 1.0 V OC
Primary	40.5 KΩ
Secondary	90.25 KΩ
Frequency Response	±1db from 150Hz to 15Hz
Turns ratio	1:1.49
Dielectric Strength	500 Vrms



124D
 5W 150Hz - 15kHz
 BRN - RED - BLU: 7000ΩCT
 GRN - BLK - GRN: 15800ΩCT
 MADE IN CANADA

SCHEMATIC DIAGRAM

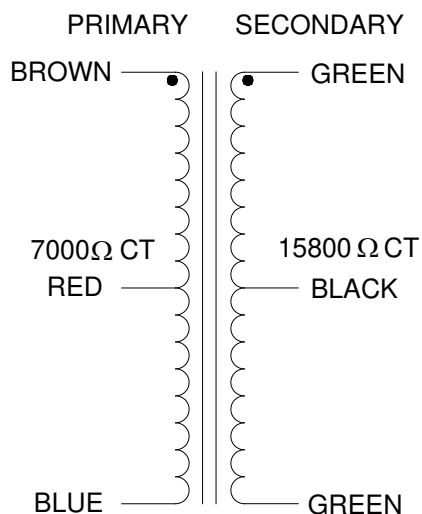

124D Rs=7K, RI=15.8K Frequency Response

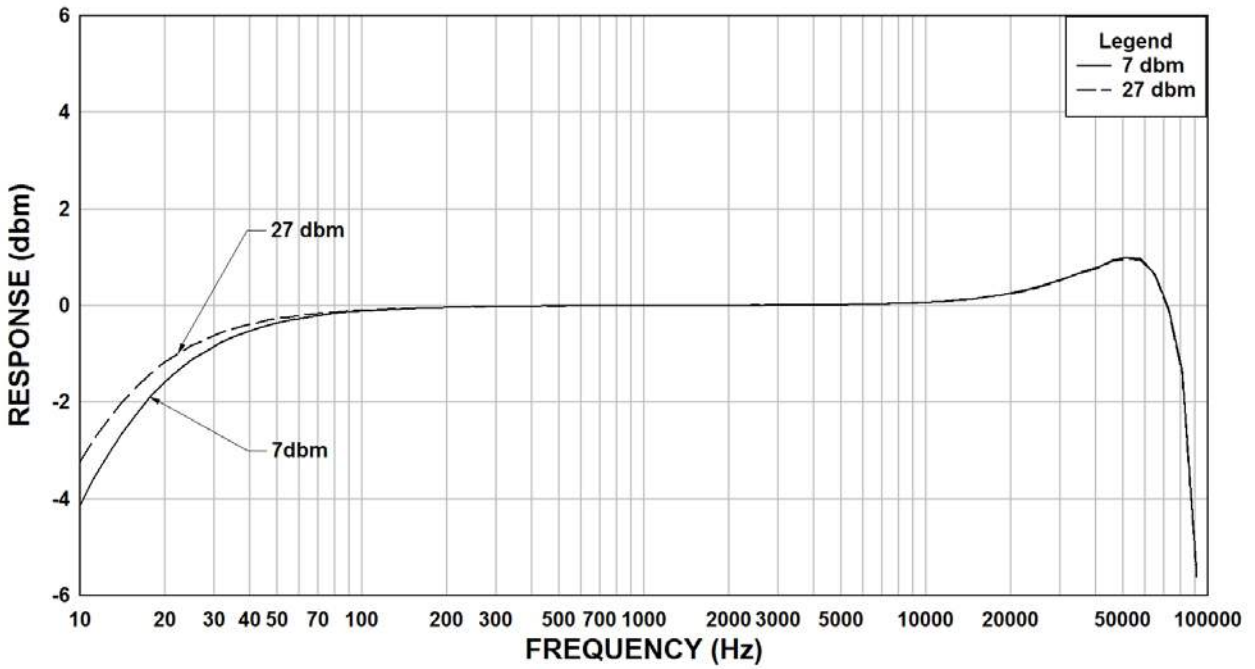

124D Rs=7K, RI=15.8K THD+N

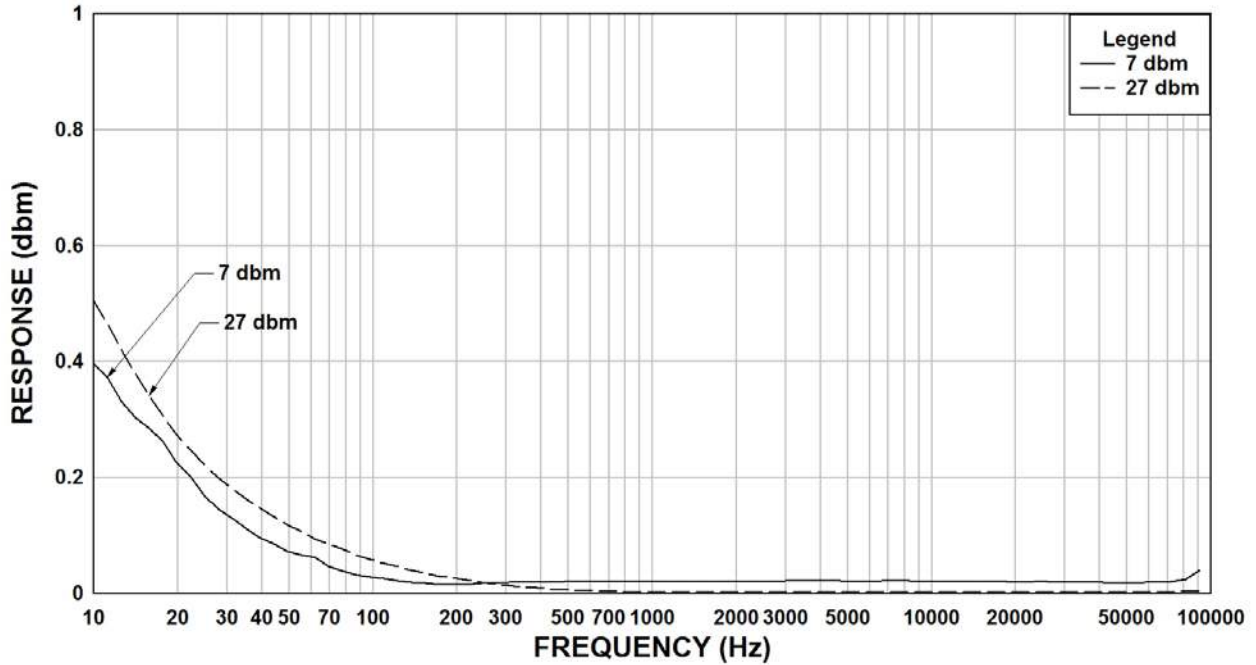

TYPICAL TEST CIRCUIT

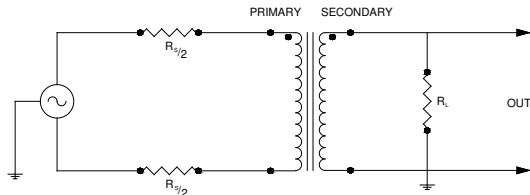

Measurement instruments
 Hp4192a impedance analyzer
 Hp3456a DVM
 Keithley 2002 DVM
 D scope series iii audio analyzer

This drawing and the information in it is the property of Hammond Manufacturing. It may not be reproduced, transmitted or used in any manner whatsoever without the written permission of Hammond Manufacturing. Data subject to change without notice.