







coil connection module connection from top, screw terminal, for contactors 3RT2.2, 3RT2.3, and 3RT2.4



product brand name	SIRIUS	
product designation	Coil connection module	
Substance Prohibitance (Date)	10/01/2009	
<b>Connections/ Terminals</b>		
type of electrical connection	screw-type terminals	
<b>Approvals Certificates</b>		
General Product Approval	EMC	Declaration of Conformity



[Confirmation](#)



Declaration of Conformity	Test Certificates	Marine / Shipping
	<a href="#">Type Test Certificates/Test Report</a>	<a href="#">Special Test Certificate</a>
EG-Konf.		
		
		

Marine / Shipping	other	Railway	Environment
		<a href="#">Confirmation</a>	<a href="#">Vibration and Shock</a>
			<a href="#">Environmental Confirmations</a>

**Further information**

Siemens has decided to exit the Russian market (see here).  
<https://press.siemens.com/global/en/pressrelease/siemens-wind-down-russian-business>  
 Siemens is working on the renewal of the current EAC certificates.  
 Please contact your local Siemens office on the status of validity of the EAC certification if you intend to import or offer to supply these products to an EAC relevant market (other than the sanctioned EAEU member states Russia or Belarus).  
 Information on the packaging  
<https://support.industry.siemens.com/cs/ww/en/view/109813875>  
 Information- and Downloadcenter (Catalogs, Brochures,...)  
<https://www.siemens.com/ic10>  
 Industry Mall (Online ordering system)  
<https://mall.industry.siemens.com/mall/en/en/Catalog/product?mlfb=3RT2926-4RA11>  
 Cax online generator  
<http://support.automation.siemens.com/WW/CAXorder/default.aspx?lang=en&mlfb=3RT2926-4RA11>

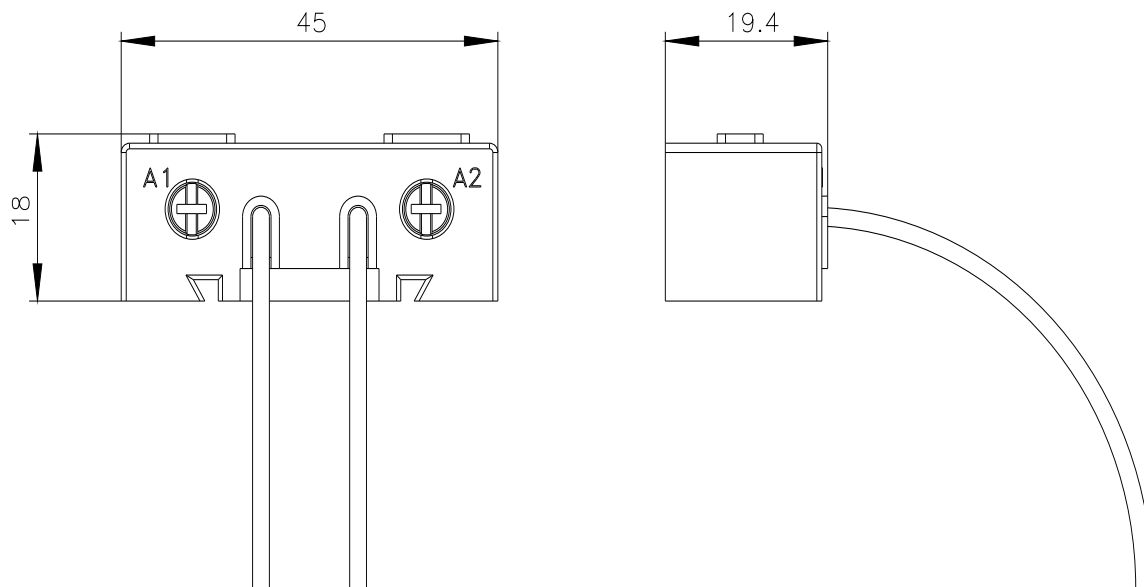

---

last modified:

12/23/2020 