

CGS74CT2524

1 to 4 Minimum Skew (300 ps) Clock Driver

General Description

These minimum skew clock drivers are designed for Clock Generation and Support (CGS) applications operating at high frequencies. This device guarantees minimum output skew across the outputs of a given device.

Skew parameters are also provided as a means to measure duty cycle requirements as those found in high speed clocking systems. The CGS74CT2524 is a minimum skew clock driver with one input driving four outputs, specifically designed for signal generation and clock distribution applications.

Features

- Guaranteed 300 ps pin-to-pin skew (t_{OSHL} and t_{OSLH})
- Implemented on National's FACT™ family process
- 1 input to 4 outputs low skew clock distribution
- Symmetric output current drive: 24 mA I_{OH}/I_{OL}
- Industrial temperature of -40°C to $+85^{\circ}\text{C}$
- 8-pin SOIC package
- Low dynamic power consumption above 20 MHz
- Guaranteed 2 kV ESD protection

Ordering Code: See Section 5

Logic Symbol

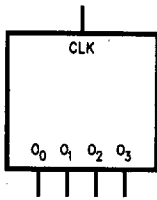

TL/F/11752-1

The output pins act as a single entity and will follow the state of the CLK when the clock distribution chip is selected.

Connection Diagrams

Pin Assignment
SOIC (M)

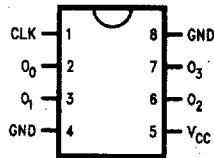

TL/F/11752-2

Pin Description

Pin Names	Description
CLK	Clock Input
O ₀ -O ₃	Outputs

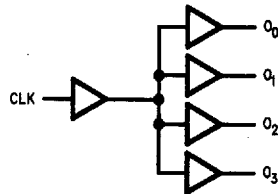

TL/F/11752-3

Truth Table

Inputs	Outputs
CLK	O ₀ -O ₃
L	L
H	H

L = Low Logic Level
H = High Logic Level

Absolute Maximum Ratings (Note)

If Military/Aerospace specified devices are required, please contact the National Semiconductor Sales Office/Distributors for availability and specifications.

Supply Voltage (V_{CC})	-0.5 to 7.0V		
DC Input Voltage Diode Current (I_{IK})			
$V = -0.5V$	-20 mA		
$V = V_{CC} + 0.5V$	+20 mA		
DC Input Voltage (V_I)	-0.5V to ($V_{CC} + 0.5V$)		
DC Output Diode (Current) (I_O)			
$V = -0.5V$	-20 mA		
$V = V_{CC} + 0.5V$	+20 mA		
DC Output Voltage (V_O)	-0.5V to ($V_{CC} + 0.5V$)		
DC Output Source or Sink Current (I_O)	± 50 mA		
DC V_{CC} or Ground Current per Output Pin (I_{CC} or I_{GND})	± 50 mA		
Storage Temperature (T_{STG})	-65°C to +150°C		
Junction Temperature (θ_{JA})	0	225	500 LFM
	M	167	132 117°C/W
	N	115	79 62°C/W

Recommended Operating Conditions

Supply Voltage (V_{CC})	4.5V to 5.5V
Input Voltage (V_I)	0V to V_{CC}
Output Voltage (V_O)	0 to V_{CC}
Operating Temperature (T_A)	-40°C to +85°C
Input Rise and Fall Times (0.8V to 2.0V)	9.6 ns max

NOTE: The Absolute Maximum Ratings are those values beyond which the safety of the device cannot be guaranteed. The device should not be operated at these limits. The parametric values defined in the DC and AC Electrical Characteristics tables are not guaranteed at the absolute maximum ratings. The Recommended Operating Conditions will define the conditions for actual device operation.

DC Electrical Characteristics

Over recommended operating conditions unless specified otherwise.

Symbol	Parameter	V_{CC} (V)	CGS74CT2524			Units	Conditions	
			$T_A = +25^\circ\text{C}$		$T_A = -40^\circ\text{C to } +85^\circ\text{C}$			
			Typ	Guaranteed Limits				
V_{IH}	Minimum High Level Input Voltage	4.5	1.5	2.0	2.0	V	$V_{OUT} = 0.1V$ or $V_{CC} = -0.1V$	
		5.5	1.5	2.0	2.0			
V_{IL}	Maximum Low Level Input Voltage	4.5	1.5	0.8	0.8	V	$V_{OUT} = 0.1V$ or $V_{CC} = -0.1V$	
		5.5	1.5	0.8	0.8			
V_{OH}	Minimum High Level Output Voltage	4.5	4.49	4.4	4.4	V	$V_{IN} = V_{IH}$ $I_{OUT} = -50 \mu\text{A}$	
		5.5	5.49	5.4	5.4			
			4.5		3.86	3.76	V	$V_{IN} = V_{IH}$ $I_{OH} = -24 \text{ mA}$
			5.5		4.86	4.76		
V_{OL}	Minimum Low Level Output Voltage	4.5	0.001	0.1	0.1	V	$V_{IN} = V_{IL}$ $I_{OUT} = 50 \mu\text{A}$	
		5.5	0.001	0.1	0.1			
			4.5		0.36	0.44	V	$V_{IN} = V_{IL}$ $I_{OL} = 24 \text{ mA}$
			5.5		0.36	0.44		
I_{IN}	Maximum Input Leakage Current	5.5		± 0.1	± 1.0	mA	$V_I = V_{CC}, \text{ GND}$	
I_{CC_T}	Maximum I_{CC} /Input	5.5	0.6		1.5	mA	$V_I = V_{CC} - 2.1V$	
I_{OLD}	Minimum Dynamic Output Current	5.5			75	mA	$V_{OLD} = 1.65V \text{ Max}$	
		5.5			-75	mA	$V_{OHD} = 3.85V \text{ Min}$	
I_{CC}	Maximum Quiescent Supply Current	5.5		8.0	80	μA	$V_{IN} = V_{CC}$ or GND	

AC Electrical CharacteristicsOver recommended operating conditions unless specified otherwise. All typical values are measured at $V_{CC} = 5V$, $T_A = 25^\circ C$.

Symbol	Parameter	CGS74CT2524			Units
		$V_{CC} = 4.5V$ to $5.5V$ $T_A = -40^\circ C$ to $+85^\circ C$ $C_L = 50$ pF $R_L = 500\Omega$			
		Min	Typ	Max	
t_{PLH}	Low-to-High Propagation Delay CLK to O_n	3.5		9.0	ns
t_{PHL}	High-to-Low Propagation Delay CLK to O_n	3.5		9.0	ns

Extended AC Electrical CharacteristicsOver recommended operating conditions unless specified otherwise. All typical values are measured at $V_{CC} = 5V$, $T_A = 25^\circ C$.

Symbol	Parameter	CGS74CT2524				Units
		$V_{CC} = 4.5V$ to $5.5V$ $T_A = -40^\circ C$ to $+85^\circ C$ $C_L = 50$ pF $R_L = 500\Omega$				
		Package	Min	Typ	Max	
F_{max}	Maximum Operating Frequency			100		MHz
t_{OSHL}	Maximum Skew Common Edge Output-to-Output Variation (Note 1)	M M (Note 2) N			300 450 500	ps
t_{OSLH}	Maximum Skew Common Edge Output-to-Output Variation (Note 1)	M M (Note 2) N			300 450 500	ps
t_{PS}	Maximum Skew Pin (Signal) Transition Variation (Note 3)				1.0	ns
t_{rise} t_{fall}	Rise Time/Fall Time (from 0.8V to 2.0V/2.0V to 0.8V)				1.5	ns
T_{High}	Time High	4				ns
T_{Low}	Time Low	4				ns

Note 1: Output-to-Output Skew is defined as the absolute value of the difference between the actual propagation delay from any outputs within the same packaged device. The specifications apply to any outputs switching in the same direction either HIGH to LOW (t_{OSHL}) or LOW to HIGH (t_{OSLH}) or in opposite directions both HL and LH (t_{OST}). t_{OSHL} and t_{OSLH} are characterized and guaranteed by design @ 1 MHz.

Note 2: Characterized at 66 MHz. Parameter guaranteed by design.

Note 3: Pin transition skew is the absolute difference between High-to-Low and Low-to-High propagation delay measure at a given output pin.

Note 4: Load capacitance includes the test jig.

Timing Diagrams

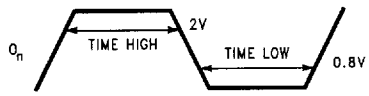
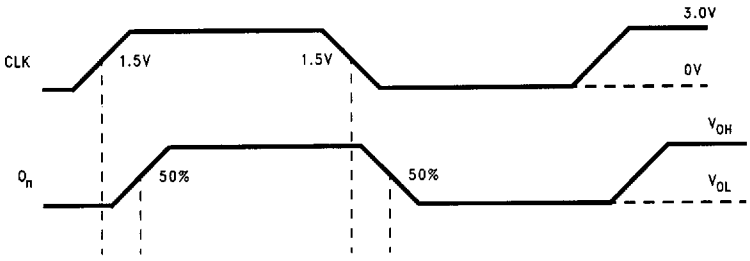
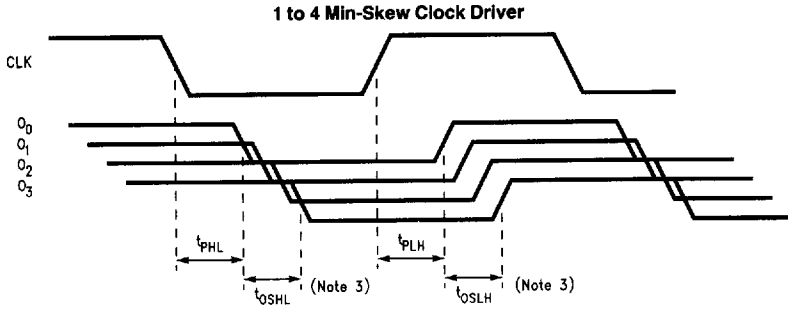

**Time high is measured with outputs above 2V.
Time low is measured with outputs below 0.8V.**

Test Circuit

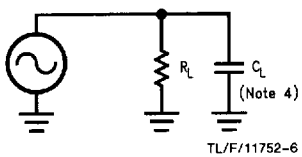

R_L is 500 Ω
 C_L is 50 pF for all prop delays and skew measurements.

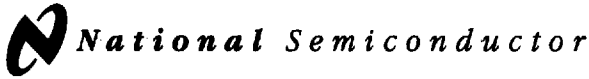

8 Lead (0.150" Wide) Molded Small Outline Package, JEDEC NS Package Number M08A

All dimensions are in inches (millimeters)

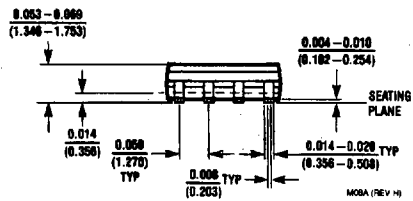
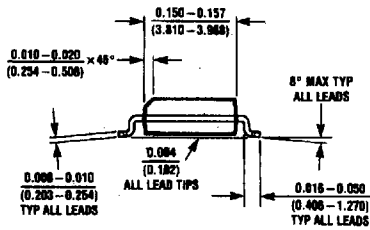
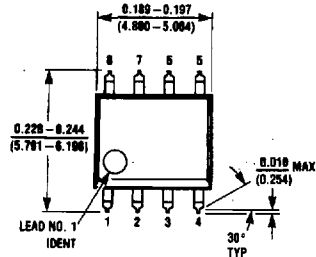

M08A (REV H)

14 Lead (0.150" Wide) Molded Small Outline Package, JEDEC NS Package Number M14A

All dimensions are in inches (millimeters)

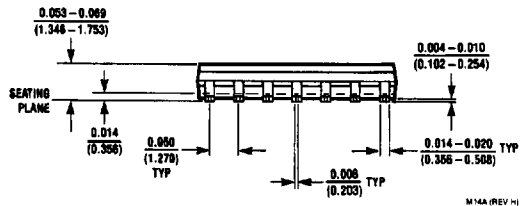
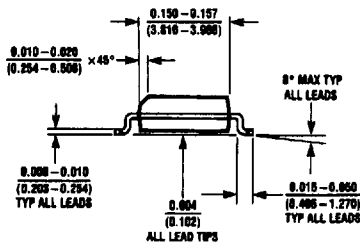
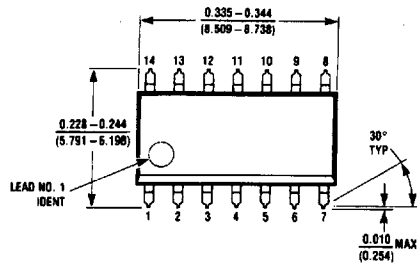

M14A (REV H)

16 Lead (0.150" Wide) Molded Small Outline Package, JEDEC NS Package Number M16A

All dimensions are in inches (millimeters)

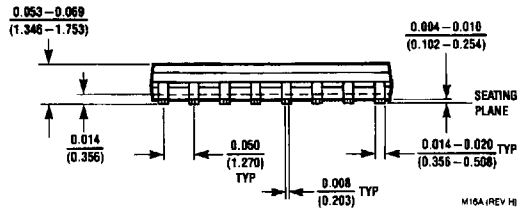
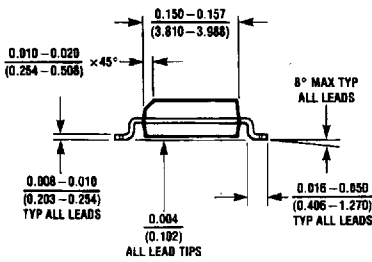
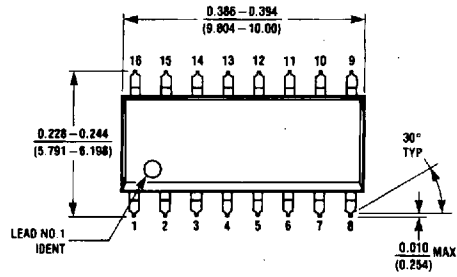

M16A (REV B)

20 Lead (0.300" Wide) Molded Small Outline Package, JEDEC NS Package Number M20B

All dimensions are in inches (millimeters)

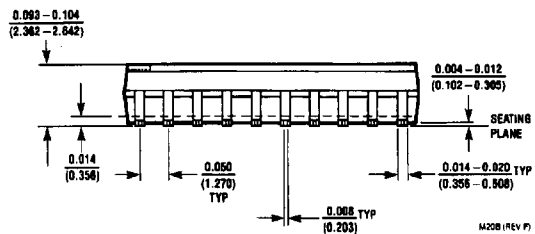
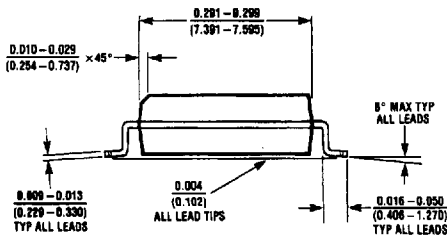
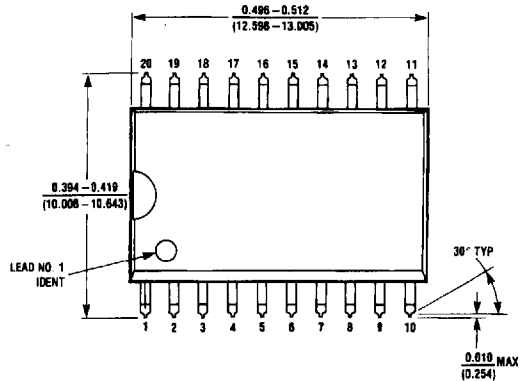

M20B (REV F)

16 Lead (0.300" Wide) Molded Dual-in-Line Package NS Package Number N16E

All dimensions are in inches (millimeters)

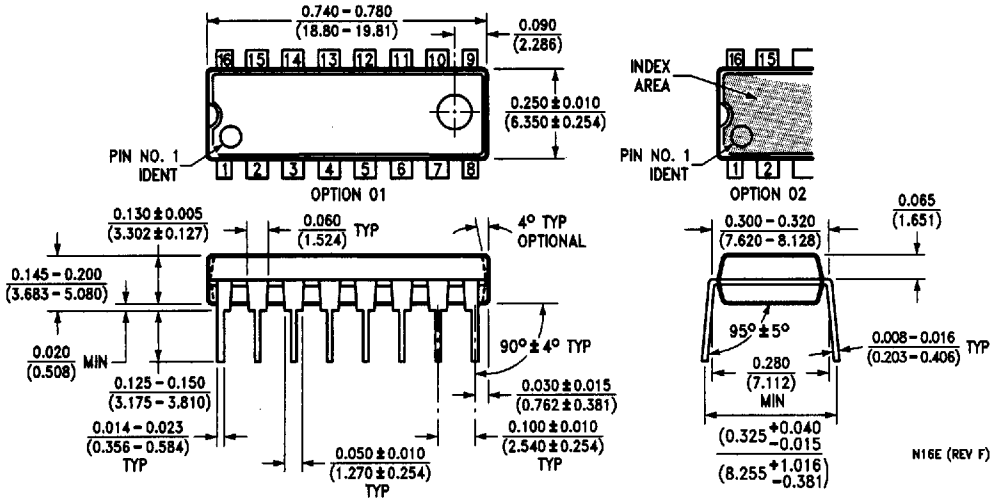

20 Lead (0.300" Wide) Molded Dual-in-Line Package NS Package Number N20A

All dimensions are in inches (millimeters)

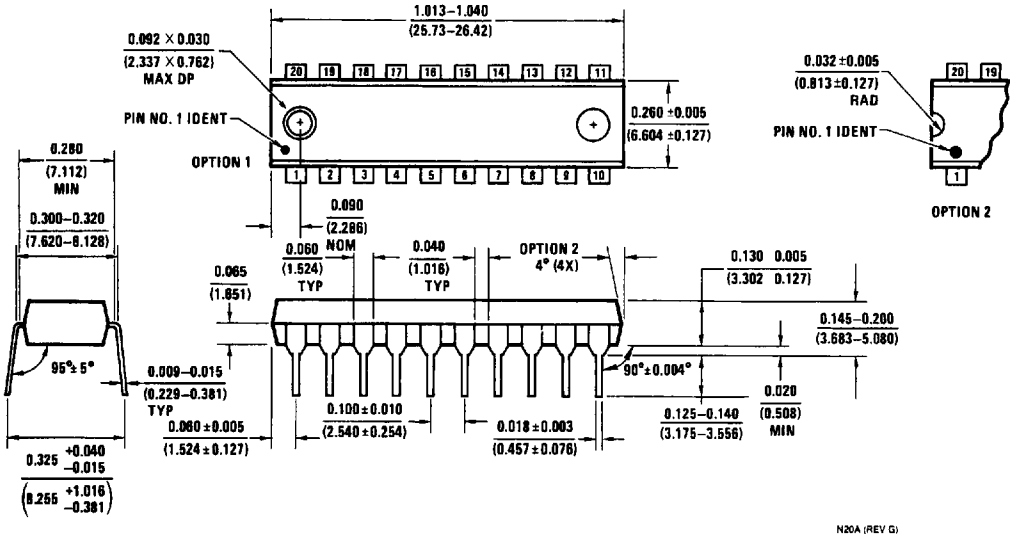

28 Lead Molded Plastic Leaded Chip Carrier NS Package Number V28A

All dimensions are in inches [millimeters]

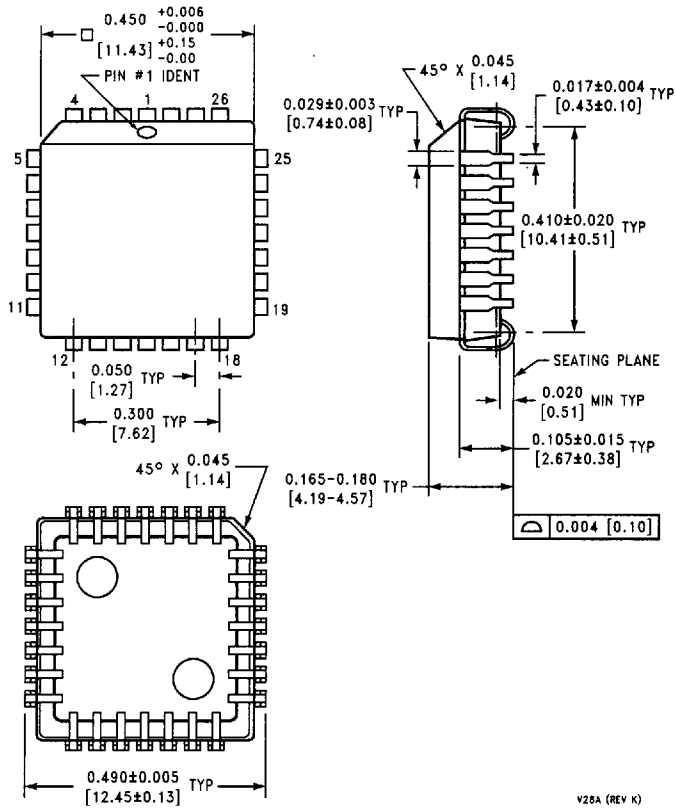

V28A (REV K)