

THESE DRAWINGS ARE THE PROPERTY OF QUALTEK ELECTRONICS AND NOT TO BE REPRODUCED FOR OR COMMUNICATED TO A THIRD PARTY WITHOUT THE EXPRESS WRITTEN PERMISSION OF AN OFFICER OF QUALTEK ELECTRONICS.

REVISION			
REV.	DESCRIPTION	DATE	APPROVED

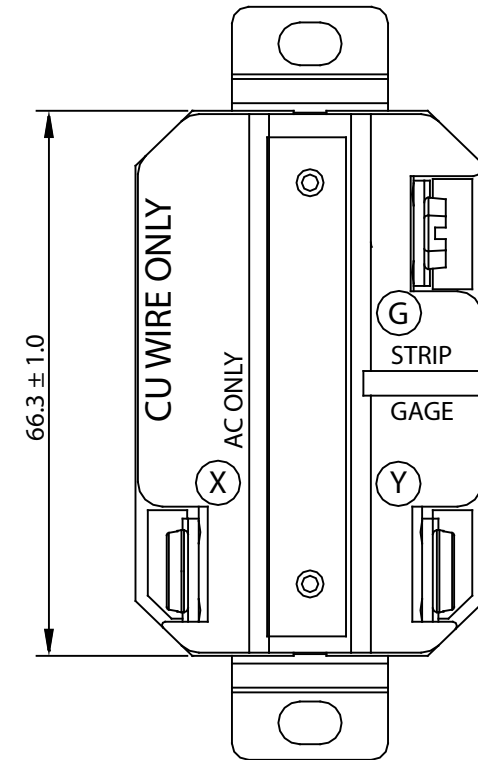
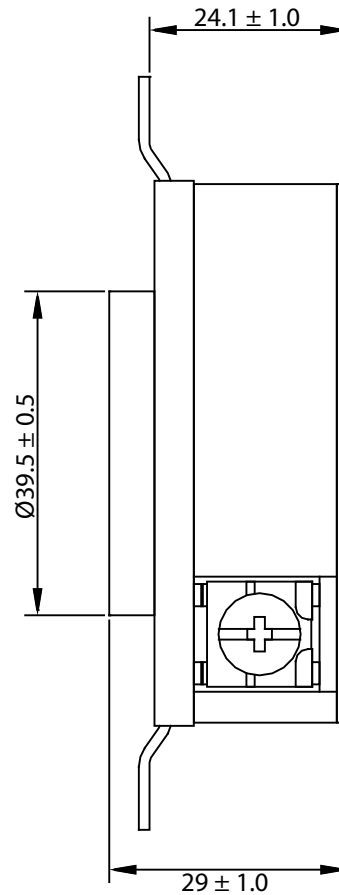
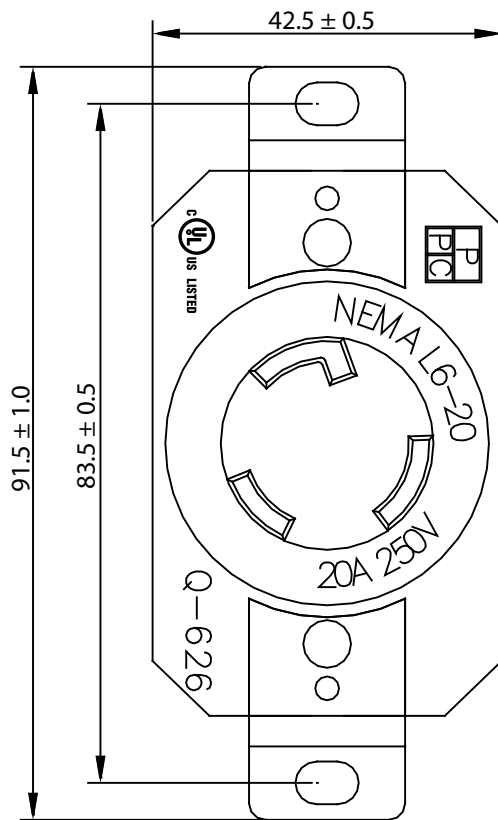

CONTROLLED

NOTES:

1. RATING: 20A 250VAC
2. COLOR: BLACK
3. ACCEPTS #10-#14 AWG COPPER WIRE
4. APPROVALS: UL/cUL LISTED
5. ROHS COMPLIANT

Dim range (mm)		Tolerance +/- (mm)	Qualtek Electronics Corp. PPC DIVISION		
0-1	0.15	Part Number: Q-626 RoHS Compliant	Description: NEMA L6-20R TWIST-LOCK RECEPTACLE		
1-6	0.20		UNIT: mm Drawn / Date Checked / Date Approved / Date R.Nuti 08-25-09 08-25-09 LY / 08-25-09		
6-18	0.30				
18-50	0.50				
50-120	0.70				
120-250	0.90				
250-500	1.20				