

TPS22929D Ultra-Small, Low on Resistance Load Switch With Controlled Turn-on

1 Features

- Integrated Single Load Switch
- Small SOT23-6 Package
- Input Voltage Range: 1.4 V to 5.5 V
- Low ON-Resistance
 - $r_{ON} = 115 \text{ m}\Omega$ at $V_{IN} = 5 \text{ V}$
 - $r_{ON} = 115 \text{ m}\Omega$ at $V_{IN} = 3.3 \text{ V}$
 - $r_{ON} = 118 \text{ m}\Omega$ at $V_{IN} = 2.5 \text{ V}$
 - $r_{ON} = 129 \text{ m}\Omega$ at $V_{IN} = 1.5 \text{ V}$
- 1.8-A Continuous Switch Current (25°C)
- Low Threshold Control Input
- Controlled Slew-rate
- Under-Voltage Lock Out
- Quick Output Discharge
- Reverse Current Protection

2 Applications

- Portable Industrial Equipment
- Portable Medical Equipment
- Portable Media Players
- Point Of Sales Terminal
- GPS Devices
- Digital Cameras
- Portable Instrumentation
- Smartphones

3 Description

The TPS22929D is a small, low r_{ON} load switch with controlled turn on. The device contains a P-channel MOSFET that can operate over an input voltage range of 1.4 V to 5.5 V. The switch is controlled by an on/off input (ON), which is capable of interfacing directly with low-voltage control signals. The TPS22929D is active high enable.

The TPS22929D contains a 150- Ω on-chip load resistor for quick output discharge when the switch is turned off. The rise time of the device is internally controlled in order to avoid inrush current.

The TPS22929D device provides circuit breaker functionality by latching off the power-switch during reverse voltage situations. An internal reverse voltage comparator disables the power-switch when the output voltage (V_{OUT}) is driven higher than the input (V_{IN}) to quickly (10 μs typ) stop the flow of current towards the input side of the switch. Reverse current is always active, even when the power-switch is disabled. Additionally, under-voltage lockout (UVLO) protection turns the switch off if the input voltage is too low.

The TPS22929D is available in a small, space-saving 6-pin SOT23 package and is characterized for operation over the free-air temperature range of -40°C to 85°C .

Device Information⁽¹⁾

PART NUMBER	PACKAGE	BODY SIZE (NOM)
TPS22929D	SOT23 (6)	2.90 mm × 1.60 mm

(1) For all available packages, see the orderable addendum at the end of the datasheet.

4 Simplified Schematic

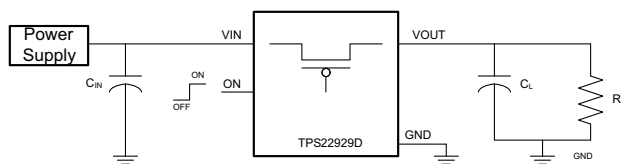

On-State Resistance vs Input Voltage

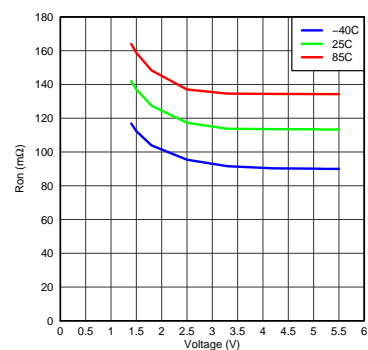

Table of Contents

1 Features	1	9.1 Overview	12
2 Applications	1	9.2 Functional Block Diagram	12
3 Description	1	9.3 Feature Description	12
4 Simplified Schematic	1	9.4 Device Functional Modes	13
5 Revision History	2	10 Application and Implementation	14
6 Pin Configuration and Functions	3	10.1 Application Information	14
7 Specifications	3	10.2 Typical Application	14
7.1 Absolute Maximum Ratings	3	11 Power Supply Recommendations	18
7.2 Handling Ratings	4	12 Layout	18
7.3 Recommended Operating Conditions	4	12.1 Layout Guidelines	18
7.4 Thermal Information	4	12.2 Layout Example	19
7.5 Electrical Characteristics	5	13 Device and Documentation Support	19
7.6 Switching Characteristics	6	13.1 Trademarks	19
7.7 Typical Characteristics	7	13.2 Electrostatic Discharge Caution	19
8 Parametric Measurement Information	10	13.3 Glossary	19
9 Detailed Description	12	14 Mechanical, Packaging, and Orderable Information	19

5 Revision History

Changes from Original (December 2011) to Revision A

Page

• Updated to enhanced datasheet standards	1
• Added Handling Ratings table.	4
• Added Thermal Information table.	4
• Added Detailed Description section.	12
• Added Application and Implementation section.	14
• Added Power Supply Recommendations section.	18
• Added Layout section.	18

6 Pin Configuration and Functions

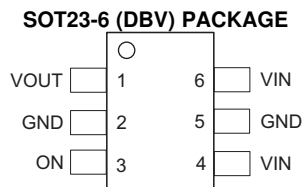

Pin Functions

PIN		DESCRIPTION
NAME	DBV	
GND	2, 5	Ground
ON	3	Switch control input, active high. Do not leave floating
VOUT	1	Switch output
VIN	4, 6	Switch input, bypass this input with a ceramic capacitor to ground

7 Specifications

7.1 Absolute Maximum Ratings

over operating free-air temperature range (unless otherwise noted)

		MIN	MAX	UNIT
V_{IN}	Input voltage range	-0.3	6	V
V_{OUT}	Output voltage range	-0.3	6	V
V_{ON}	Input voltage range	-0.3	6	V
P_{MAX}	Maximum continuous power dissipation at 25°C		463	mW
	Maximum continuous power dissipation at 70°C		254	
	Maximum continuous power dissipation at 85°C		185	
I_{MAX}	Maximum continuous operating current		2	A
T_A	Operating free-air temperature range	-40	85	°C
T_J	Maximum junction temperature		125	°C

7.2 Handling Ratings

		MIN	MAX	UNIT	
T_{stg}	Storage temperature range	-65	150	°C	
$V_{(ESD)}$	Electrostatic discharge	Human body model (HBM), per ANSI/ESDA/JEDEC JS-001, all pins ⁽¹⁾	-2	2	kV
		Charged device model (CDM), per JEDEC specification JESD22-C101, all pins ⁽²⁾	-1	1	

- (1) JEDEC document JEP155 states that 500-V HBM allows safe manufacturing with a standard ESD control process. Pins listed as 2 kV may actually have higher performance.
- (2) JEDEC document JEP157 states that 250-V CDM allows safe manufacturing with a standard ESD control process. Pins listed as 1 kV may actually have higher performance.

7.3 Recommended Operating Conditions

		MIN	MAX	UNIT
V_{IN}	Input voltage range	1.4	5.5	V
V_{ON}	ON voltage range	0	5.5	V
V_{OUT}	Output voltage range		V_{IN}	
V_{IH}	High-level input voltage, ON	$V_{IN} = 1.4 \text{ V to } 5.5 \text{ V}$		V
V_{IL}	Low-level input voltage, ON	$V_{IN} = 3.61 \text{ V to } 5.5 \text{ V}$		0.6
		$V_{IN} = 1.4 \text{ V to } 3.6 \text{ V}$		0.4
C_{IN}	Input Capacitor	1 ⁽¹⁾		μF

- (1) Refer to the application section.

7.4 Thermal Information

THERMAL METRIC ⁽¹⁾		TPS22929D	UNITS
		DBV	
		6 PINS	
$R_{\theta JA}$	Junction-to-ambient thermal resistance	216	°C/W
$R_{\theta JCTop}$	Junction-to-case (top) thermal resistance	209	
$R_{\theta JB}$	Junction-to-board thermal resistance	131	
Ψ_{JT}	Junction-to-top characterization parameter	52	
Ψ_{JB}	Junction-to-board characterization parameter	110	

- (1) For more information about traditional and new thermal metrics, see the *IC Package Thermal Metrics* application report, [SPRA953](#).

7.5 Electrical Characteristics

VIN = 1.4 V to 5.5 V, TA = –40°C to 85°C (unless otherwise noted)

PARAMETER	TEST CONDITIONS	TA	MIN	TYP	MAX	UNIT						
I _{IN}	Quiescent current	Full			I _{OUT} = 0, V _{IN} = V _{ON} = 5.25 V	2.2	10	μA				
					I _{OUT} = 0, V _{IN} = V _{ON} = 4.2 V	2.1	7.0					
					I _{OUT} = 0, V _{IN} = V _{ON} = 3.6 V	2.0	7.0					
					I _{OUT} = 0, V _{IN} = V _{ON} = 2.5 V	1.0	5.0					
					I _{OUT} = 0, V _{IN} = V _{ON} = 1.5 V	0.8	5.0					
I _{IN(off)}	Off supply current	Full			V _{ON} = GND, V _{OUT} = Open, V _{IN} = 5.25 V	0.8	10	μA				
					V _{ON} = GND, V _{OUT} = Open, V _{IN} = 4.2 V	0.3	7.0					
					V _{ON} = GND, V _{OUT} = Open, V _{IN} = 3.6 V	0.2	7.0					
					V _{ON} = GND, V _{OUT} = Open, V _{IN} = 2.5 V	0.2	5.0					
					V _{ON} = GND, V _{OUT} = Open, V _{IN} = 1.5 V	0.1	5.0					
I _{IN(Leakage)}	Leakage current	Full			V _{ON} = GND, V _{OUT} = 0, V _{IN} = 5.25 V	0.8	10	μA				
					V _{ON} = GND, V _{OUT} = 0, V _{IN} = 4.2 V	0.3	7.0					
					V _{ON} = GND, V _{OUT} = 0, V _{IN} = 3.6 V	0.2	7.0					
					V _{ON} = GND, V _{OUT} = 0, V _{IN} = 2.5 V	0.2	5.0					
					V _{ON} = GND, V _{OUT} = 0, V _{IN} = 1.5 V	0.1	5.0					
r _{ON}	On-resistance	25°C	Full			V _{IN} = 5.25 V, I _{OUT} = –200 mA	115	150	mΩ			
						V _{IN} = 5.0 V, I _{OUT} = –200 mA	115	150				
		25°C	Full				V _{IN} = 4.2 V, I _{OUT} = –200 mA	115		150		
							V _{IN} = 3.3 V, I _{OUT} = –200 mA	115		150		
		25°C	Full				V _{IN} = 2.5 V, I _{OUT} = –200 mA	118		155		
							V _{IN} = 1.5 V, I _{OUT} = –200 mA	129		170		
		25°C	Full							175		
										200		
		RPD	Output pull down resistance	25°C				V _{IN} = 3.3 V, V _{ON} = 0, I _{OUT} = 30 mA		150	200	Ω
		UVLO	Under voltage lockout	Full				V _{IN} increasing, V _{ON} = 3.6 V, I _{OUT} = –100 mA			1.4	V
								V _{IN} decreasing, V _{ON} 3.6 V, R _L = 10 Ω		0.50		
		I _{ON}	ON input leakage current	Full				V _{ON} = 1.4 V to 5.25 V or GND			1	μA
V _{RVP}	Reverse Current Voltage Threshold							77	mV			
t _{DELAY}	Reverse Current Response Delay					V _{IN} = 5V		10	μs			

7.6 Switching Characteristics

PARAMETER		TEST CONDITION	TPS22929D	UNIT
			TYP	
VIN = 5 V, TA = 25°C (unless otherwise noted)				
t _{ON}	Turn-ON time	R _L = 10 Ω, C _L = 0.1 μF	3315	μs
t _{OFF}	Turn-OFF time	R _L = 10 Ω, C _L = 0.1 μF	7.4	
t _R	VOUT rise time	R _L = 10 Ω, C _L = 0.1 μF	3660	
t _F	VOUT fall time	R _L = 10 Ω, C _L = 0.1 μF	6.1	
VIN = 3.3 V, TA = 25°C (unless otherwise noted)				
t _{ON}	Turn-ON time	R _L = 10 Ω, C _L = 0.1 μF	4655	μs
t _{OFF}	Turn-OFF time	R _L = 10 Ω, C _L = 0.1 μF	9.5	
t _R	VOUT rise time	R _L = 10 Ω, C _L = 0.1 μF	4150	
t _F	VOUT fall time	R _L = 10 Ω, C _L = 0.1 μF	3.0	
VIN = 1.5 V, TA = 25°C (unless otherwise noted)				
t _{ON}	Turn-ON time	R _L = 10 Ω, C _L = 0.1 μF	10175	μs
t _{OFF}	Turn-OFF time	R _L = 10 Ω, C _L = 0.1 μF	18.3	
t _R	VOUT rise time	R _L = 10 Ω, C _L = 0.1 μF	7812	
t _F	VOUT fall time	R _L = 10 Ω, C _L = 0.1 μF	3.0	

7.7 Typical Characteristics

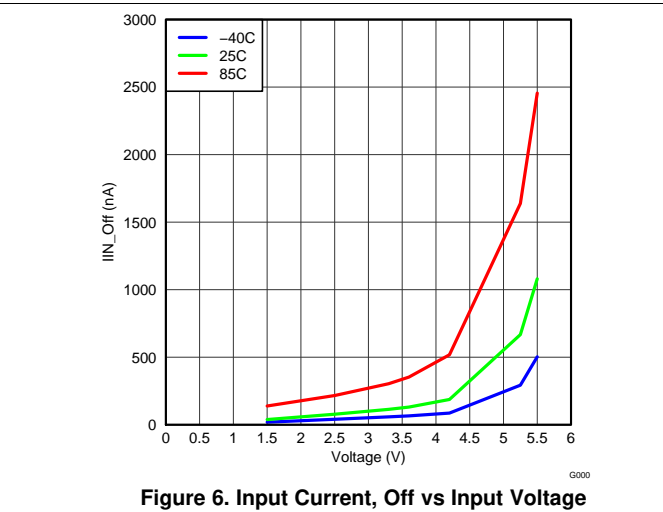
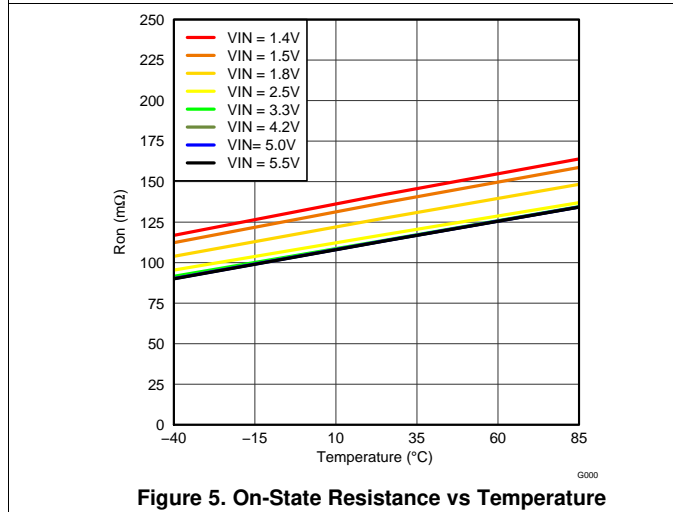
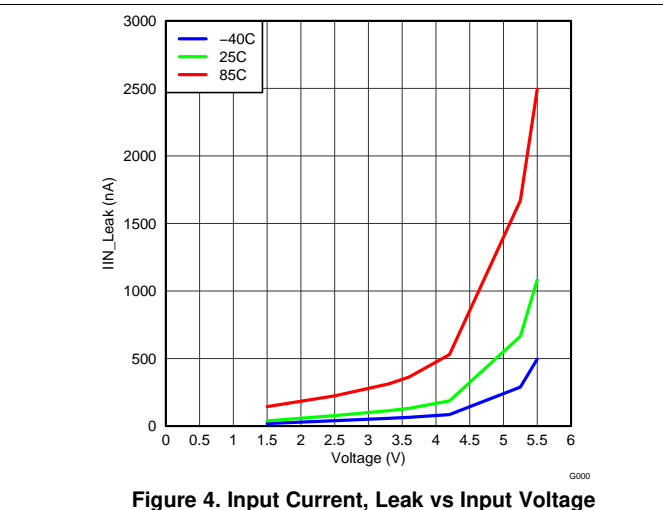
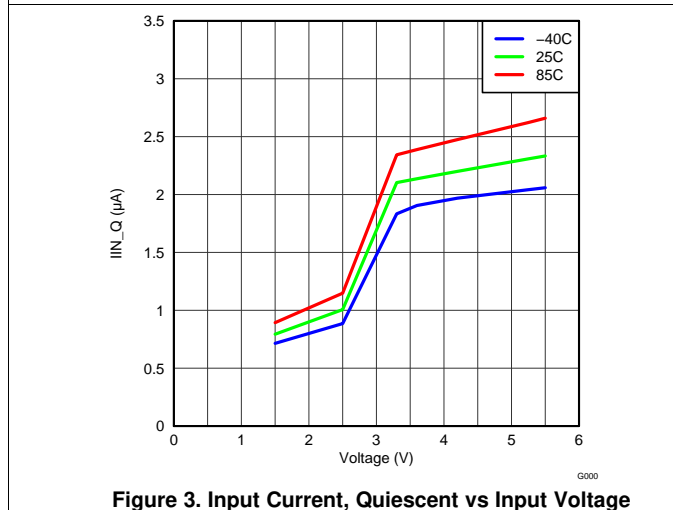
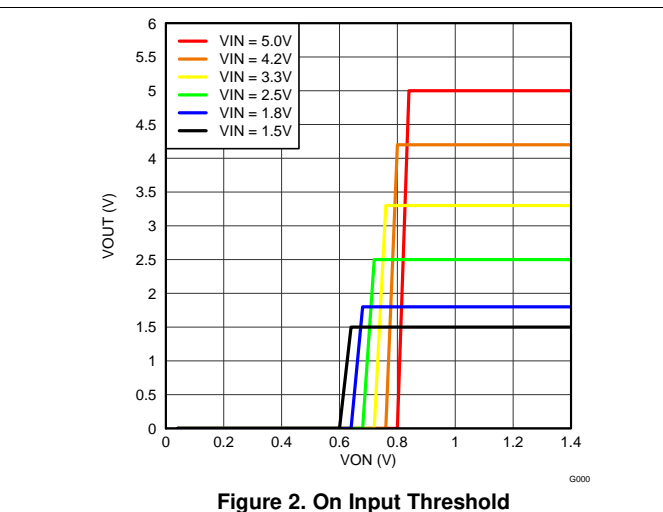
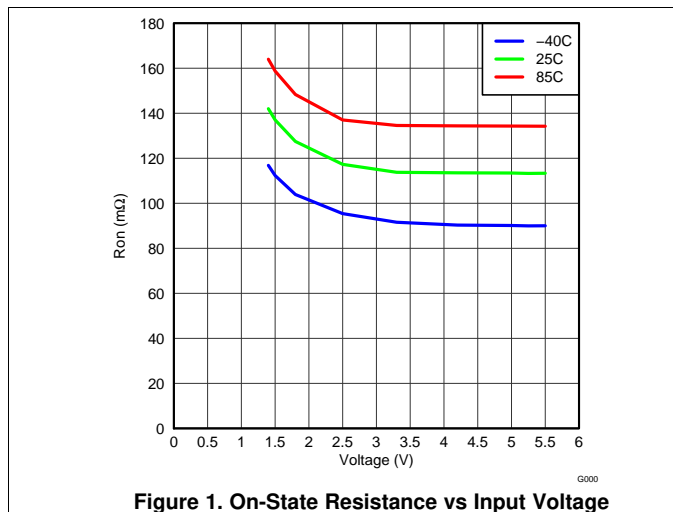

Typical Characteristics (continued)

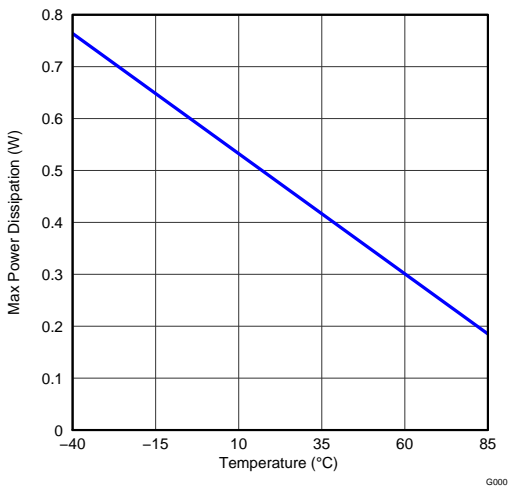

Figure 7. Allowable Power Dissipation

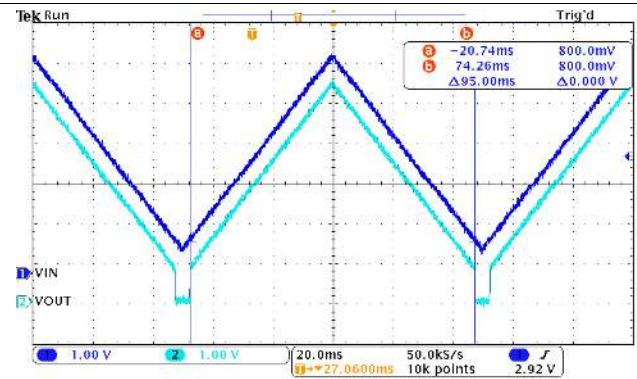

Figure 8. Under-Voltage Lockout Response (IOUT = -100mA)

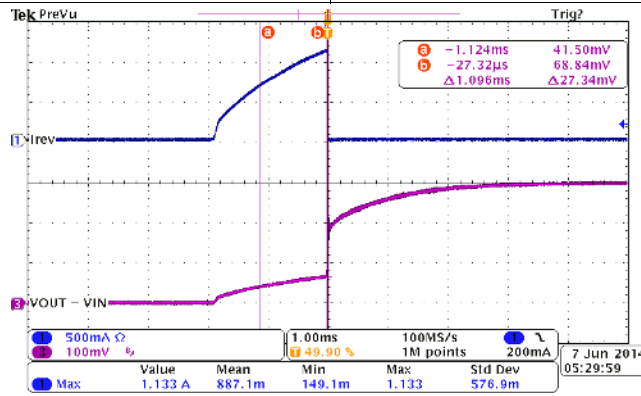

Figure 9. Reverse Current Protection (VIN = 3.0 V, VOUT Ramp up From 3.0 V to 3.3 V)

7.7.1 Typical AC Characteristics

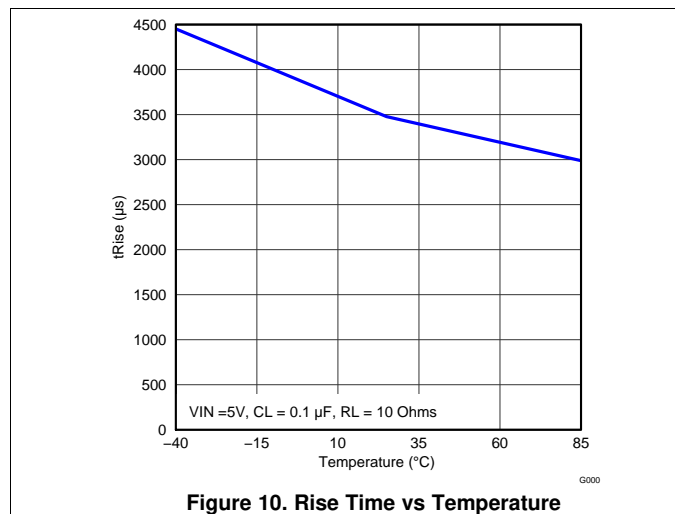

Figure 10. Rise Time vs Temperature

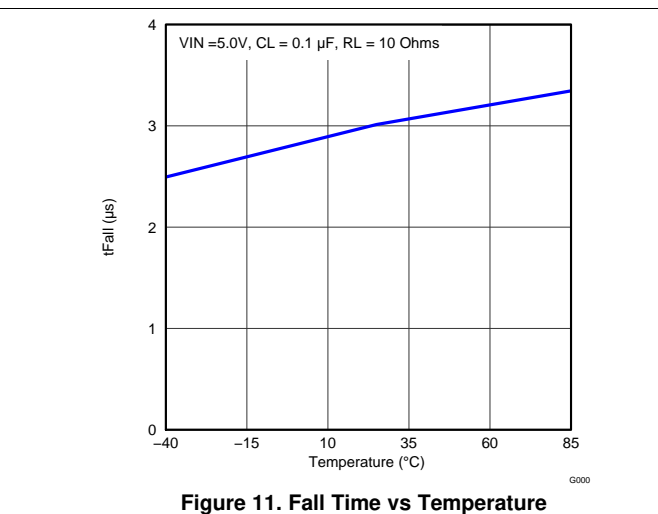

Figure 11. Fall Time vs Temperature

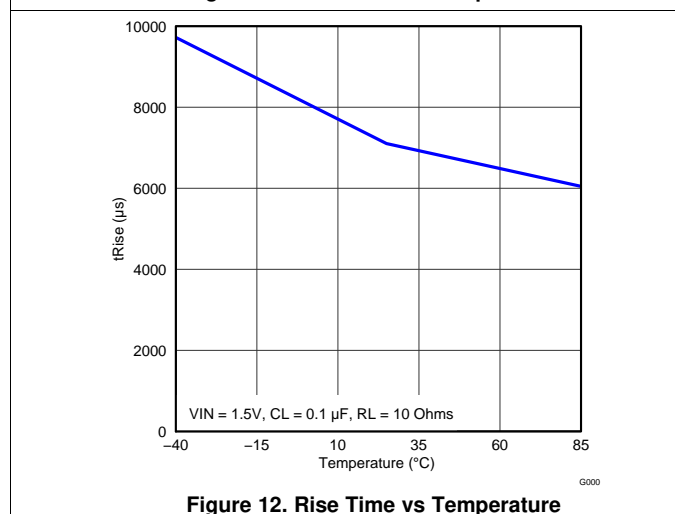

Figure 12. Rise Time vs Temperature

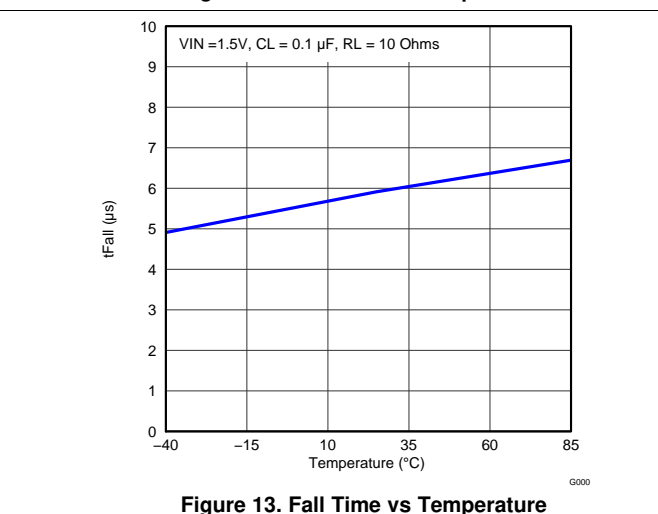

Figure 13. Fall Time vs Temperature

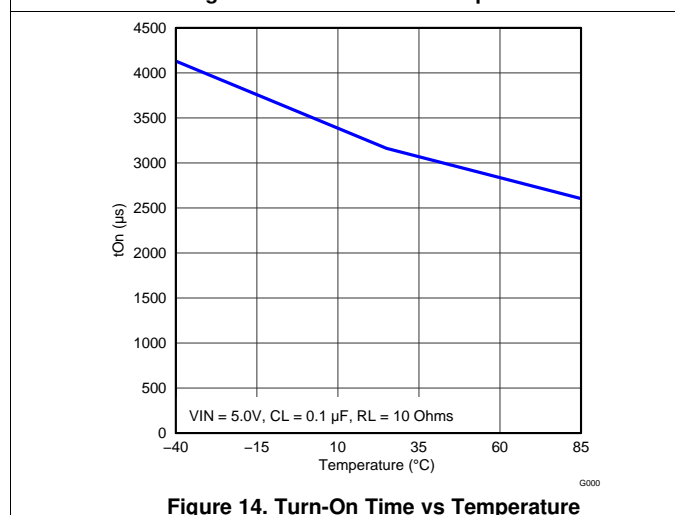

Figure 14. Turn-On Time vs Temperature

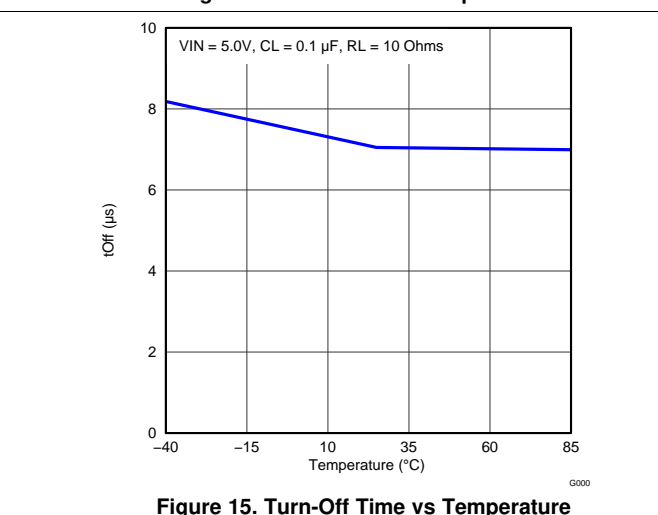

Figure 15. Turn-Off Time vs Temperature

Typical AC Characteristics (continued)

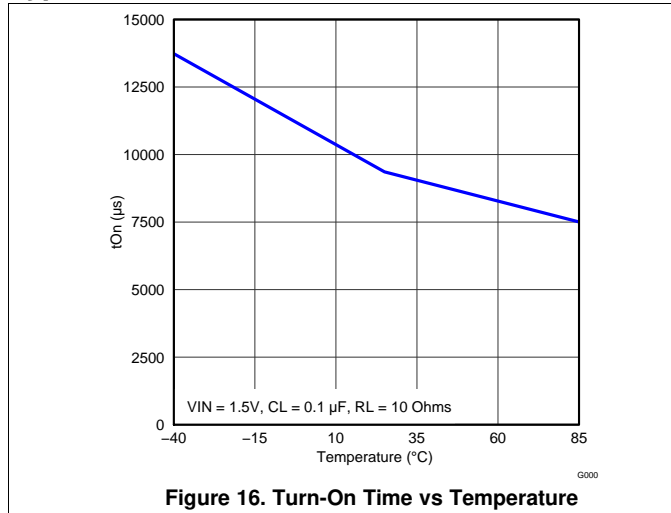

Figure 16. Turn-On Time vs Temperature

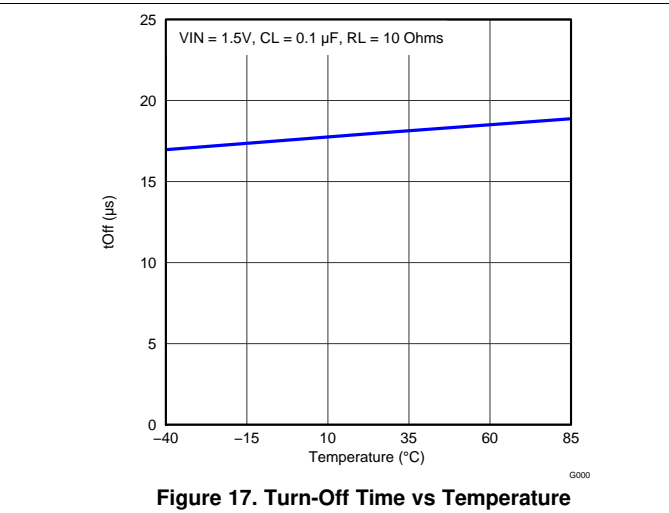

Figure 17. Turn-Off Time vs Temperature

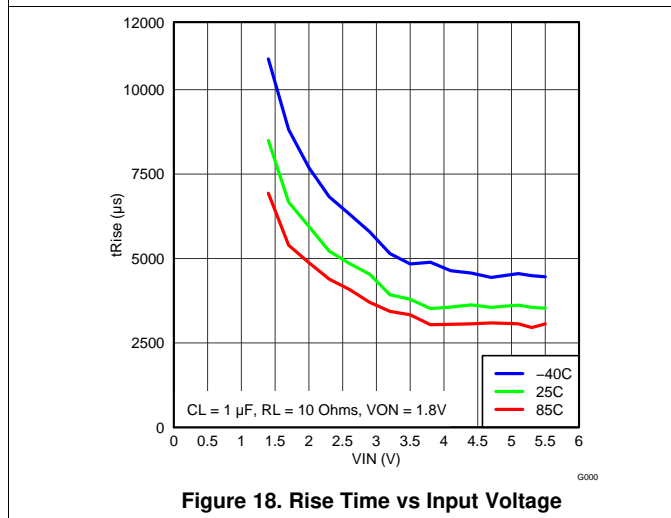

Figure 18. Rise Time vs Input Voltage

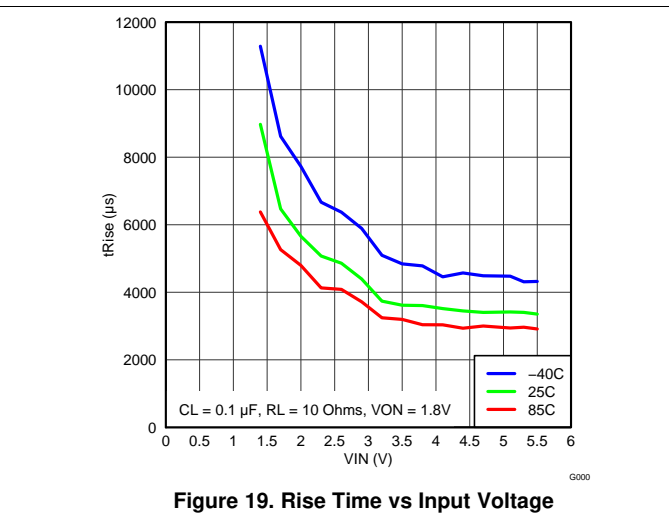
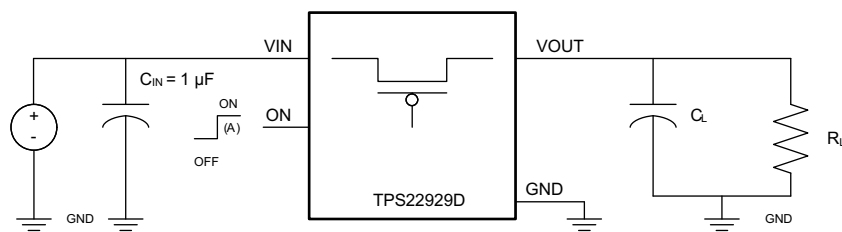

Figure 19. Rise Time vs Input Voltage

8 Parametric Measurement Information



A. Rise and fall times of the control signal is 100 ns.

Figure 20. Test Circuit

Parametric Measurement Information (continued)

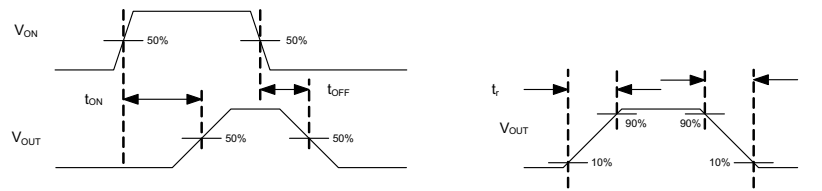

Figure 21. T_{ON}/T_{OFF} Waveforms

9 Detailed Description

9.1 Overview

The TPS22929D is a single channel, 1.8-A load switch in a small, space-saving 6-pin SOT23-6 package. This device implements a low resistance P-channel MOSFET with a controlled rise time for applications that need to limit the inrush current.

This device is also designed to have very low leakage current during off state. This prevents downstream circuits from pulling high standby current from the supply. Integrated control logic, driver, power supply, and output discharge FET eliminates the need for additional external components, which reduces solution size and bill of materials (BOM) count.

9.2 Functional Block Diagram

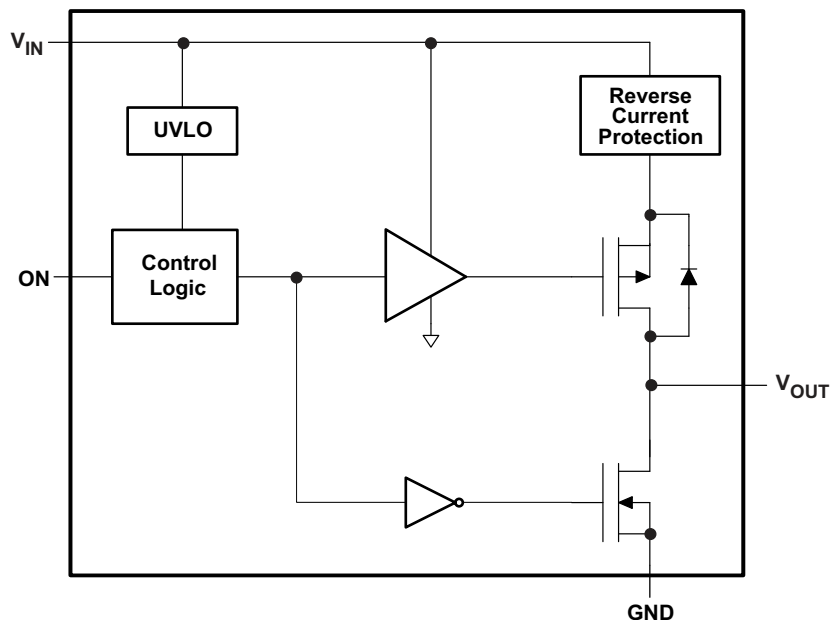

9.3 Feature Description

9.3.1 On/Off Control

The ON pin controls the state of the switch. Asserting ON high enables the switch. ON is active high and has a low threshold, making it capable of interfacing with low-voltage signals. The ON pin is compatible with standard GPIO logic threshold. It can be used with any microcontroller with 1.2-V, 1.8-V, 2.5-V or 3.3-V GPIOs.

9.3.2 Output Pull-Down

The output pull-down is active when the user is turning off the main pass FET. The pull-down discharges the output rail to approximately 10% of the rail, and then the output pull-down is automatically disconnected to optimize the shutdown current.

9.3.3 Under-Voltage Lockout

The under-voltage lockout turns-off the switch if the input voltage drops below the under-voltage lockout threshold. During under-voltage lockout (UVLO), if the voltage level at V_{OUT} exceeds the voltage level at V_{IN} by the Reverse Current Voltage Threshold (V_{RVP}), the body diode will be disengaged to prevent any current flow to V_{IN} . With the ON pin active the input voltage rising above the under-voltage lockout threshold will cause a controlled turn-on of the switch which limits current over-shoots.

Feature Description (continued)

9.3.4 Reverse Current Protection

In a scenario where V_{OUT} is greater than V_{IN} , there is potential for reverse current through the pass FET or the body diode. The TPS22929D monitors V_{IN} and V_{OUT} voltage levels. When the reverse current voltage threshold (V_{RVP}) is exceeded, the switch is disabled (within 10 μ s typ). Additionally, the body diode is disengaged so as to prevent any reverse current flow to V_{IN} . The FET, and the output (V_{OUT}), will resume normal operation when the reverse voltage scenario is no longer present.

Use the following formula to calculate the amount of reverse current required to activate the protection circuit for a particular application:

$$I_{RC} = \frac{0.077V}{R_{ON(VIN)}}$$

Where,

I_{RC} is the amount of reverse current,

$R_{ON(VIN)}$ is the on-resistance as determined by the input voltage.

9.4 Device Functional Modes

Table 1. Function Table

ON	VIN to VOUT	VOUT to GND ⁽¹⁾
L	OFF	ON
H	ON	OFF

(1) See [Output Pull-Down](#) section.

10 Application and Implementation

10.1 Application Information

10.1.1 VIN to VOUT Voltage Drop

The VIN to VOUT voltage drop in the device is determined by the R_{ON} of the device and the load current. The R_{ON} of the device depends upon the VIN condition of the device. Refer to the R_{ON} specification of the device in the Electrical Characteristics table of this datasheet. Once the R_{ON} of the device is determined based upon the VIN conditions, use [Equation 1](#) to calculate the VIN to VOUT voltage drop:

$$\Delta V = I_{LOAD} \times R_{ON} \quad (1)$$

Where,

ΔV = Voltage drop from VIN to VOUT

I_{LOAD} = Load current

R_{ON} = On-resistance of the device for a specific V_{IN}

An appropriate I_{LOAD} must be chosen such that the I_{MAX} specification of the device is not violated.

10.1.2 Input Capacitor

To limit the voltage drop on the input supply caused by transient inrush currents, when the switch turns on into a discharged load capacitor or short-circuit, a capacitor needs to be placed between VIN and GND. A 1- μ F ceramic capacitor, C_{IN} , placed close to the pins is usually sufficient. Higher values of C_{IN} can be used to further reduce the voltage drop.

10.1.3 Output Capacitor

A C_{IN} to C_L ratio of 10 to 1 is recommended for minimizing V_{IN} dip caused by inrush currents during startup.

10.2 Typical Application

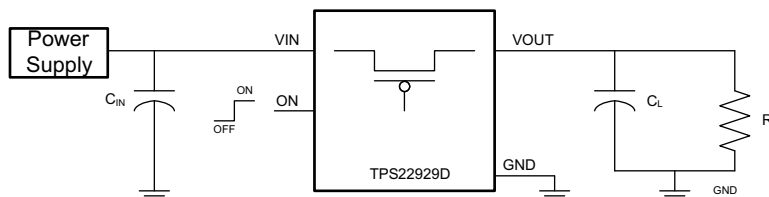

Figure 22. Typical Application Schematic

10.2.1 Design Requirements

Design Parameter	Example Value
VIN	1.5 V to 5 V
CL	0.1 μ F to 1 μ F
Maximum Acceptable Inrush Current	10 mA

10.2.2 Detailed Design Procedure

10.2.2.1 Managing Inrush Current

When the switch is enabled, the output capacitors must be charged up from 0-V to VIN voltage. This charge arrives in the form of inrush current. Inrush current can be calculated using the following equation:

$$\text{Inrush Current} = C \times \frac{dv}{dt} \quad (2)$$

Where,

C = Output capacitance

$\frac{dv}{dt}$ = Output slew rate

The TPS22929D offers a very slow controlled rise time for minimizing inrush current. This device can be selected based upon the maximum acceptable slew rate which can be calculated using the design requirements and the inrush current equation. An output capacitance of 1.0 μF will be used since the amount of inrush increases with output capacitance:

$$10 \text{ mA} = 1.0 \mu\text{F} \times \frac{dv}{dt} \quad (3)$$

$$\frac{dv}{dt} = 10 \text{ V/ms} \quad (4)$$

To ensure an inrush current of less than 10 mA, a device with a slew rate less than 10 V/ms must be used.

The TPS22929D has a typical rise time of 4500 μs at 3.3 V . This results in a slew rate of 733 mV/ms which meets the above design requirements.

10.2.3 Application Curves

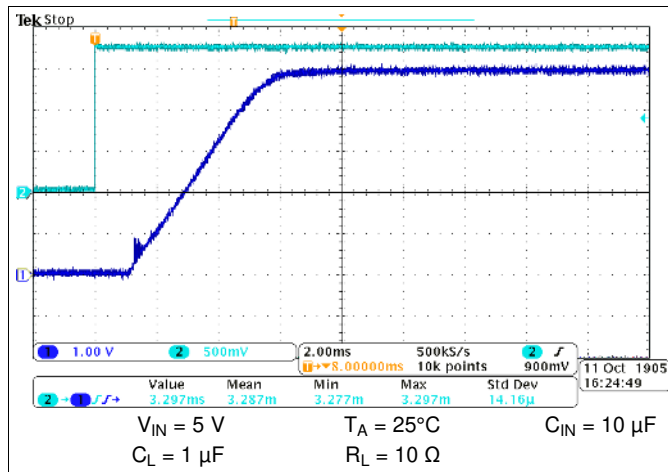

Figure 23. Turn-On Response

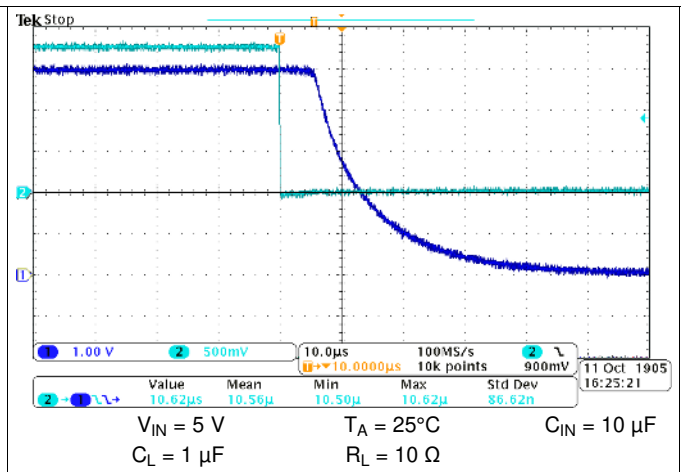

Figure 24. Turn-Off Response

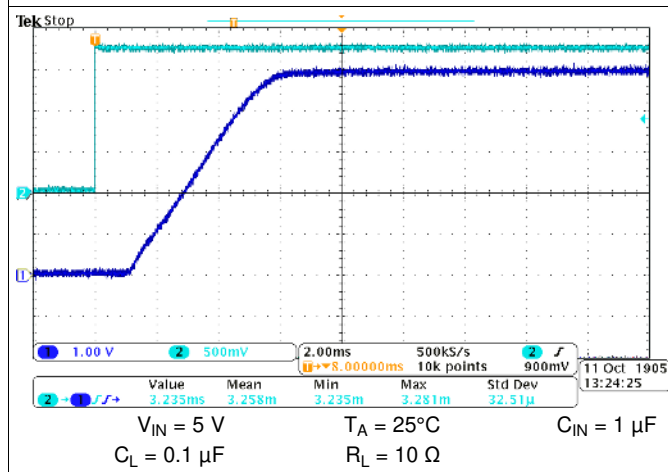

Figure 25. Turn-On Response Time

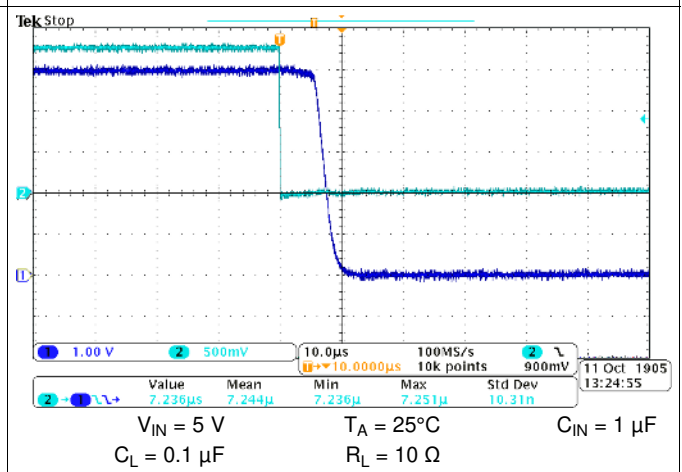

Figure 26. Turn-Off Response Time

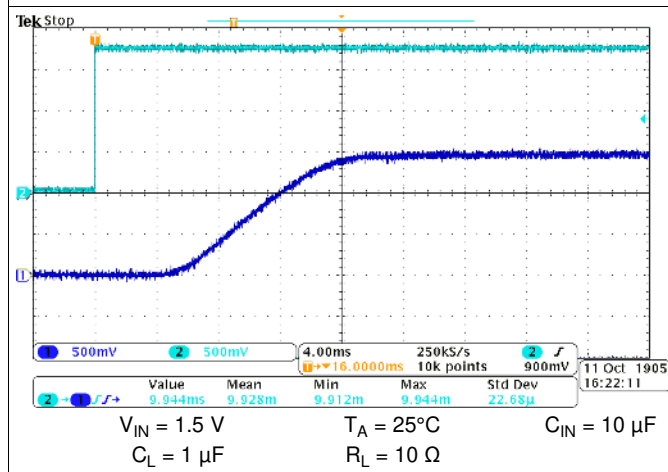

Figure 27. Turn-On Response Time

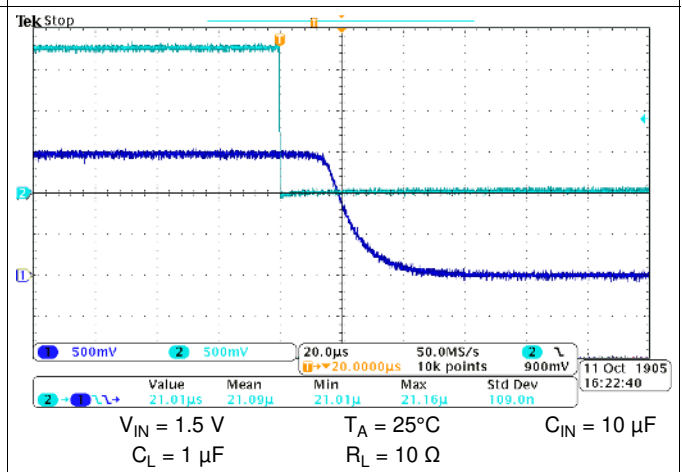
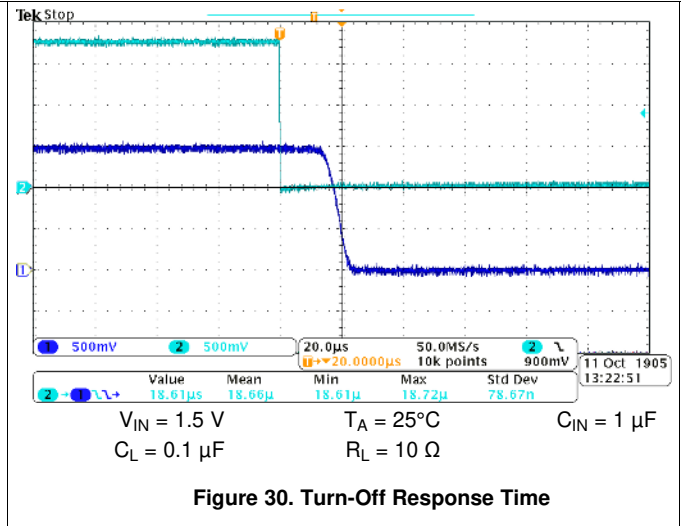
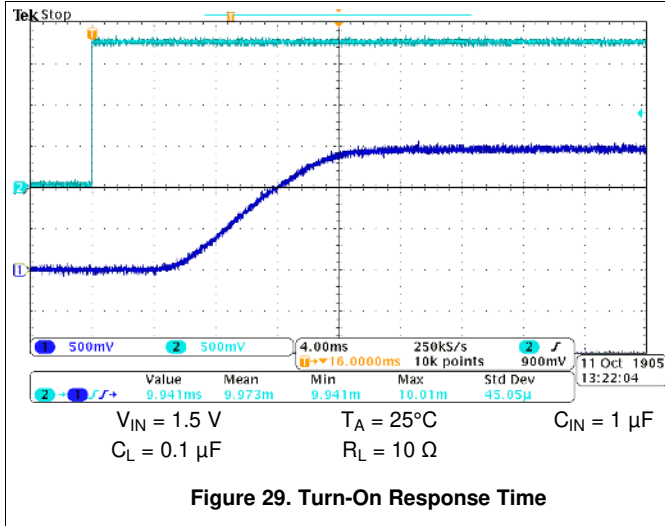

Figure 28. Turn-Off Response Time



11 Power Supply Recommendations

The device is designed to operate with a VIN range of 1.4 V to 5.5 V.

12 Layout

12.1 Layout Guidelines

For best performance, all traces should be as short as possible. To be most effective, the input and output capacitors should be placed close to the device to minimize the effects that parasitic trace inductances may have on normal operation. Using wide traces for VIN, VOUT, and GND helps minimize the parasitic electrical effects along with minimizing the case to ambient thermal impedance.

12.1.1 Thermal Considerations

For best device performance, be sure to follow the thermal guidelines in the [Thermal Information](#) table. To calculate max allowable continuous current for your application for a specific VIN and ambient temperature, use the following formula:

$$I_{MAX} = \sqrt{\frac{T_J - T_A}{\theta_{JA} R_{ON}}}$$

Where:

I_{MAX}= Max allowable continuous current

T_J= Max thermal junction temperature (125°C)

T_A= Ambient temperature of the application

θ_{JA}= Junction-to-air thermal impedance (216°C/W)

R_{ON}= R_{ON} at a specified input voltage VIN (see [Electrical Characteristics](#))

12.2 Layout Example

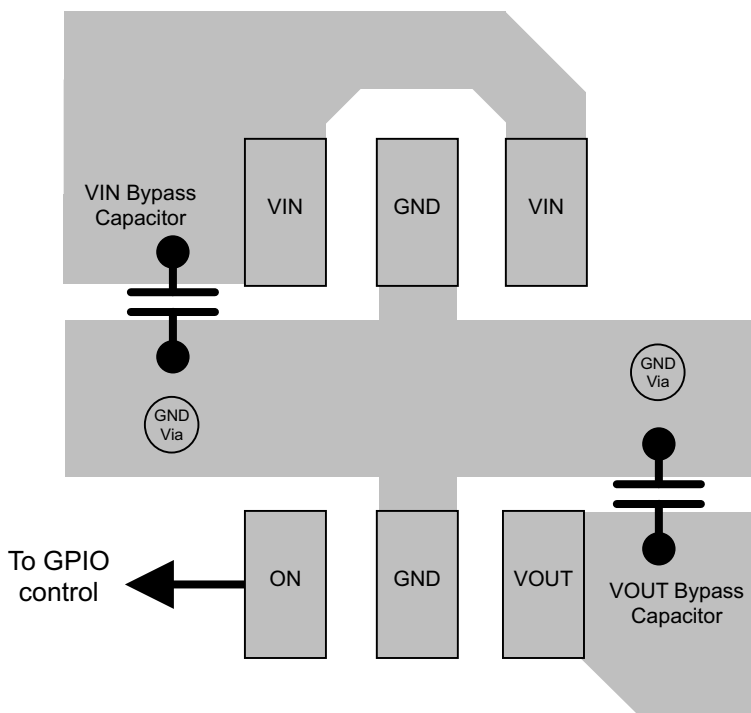

Figure 31. Layout Drawing

13 Device and Documentation Support

13.1 Trademarks

All trademarks are the property of their respective owners.

13.2 Electrostatic Discharge Caution



These devices have limited built-in ESD protection. The leads should be shorted together or the device placed in conductive foam during storage or handling to prevent electrostatic damage to the MOS gates.

13.3 Glossary

[SLYZ022](#) — *TI Glossary*.

This glossary lists and explains terms, acronyms, and definitions.

14 Mechanical, Packaging, and Orderable Information

The following pages include mechanical, packaging, and orderable information. This information is the most current data available for the designated devices. This data is subject to change without notice and revision of this document. For browser-based versions of this data sheet, refer to the left-hand navigation.

PACKAGING INFORMATION

Orderable Device	Status (1)	Package Type	Package Drawing	Pins	Package Qty	Eco Plan (2)	Lead finish/ Ball material (6)	MSL Peak Temp (3)	Op Temp (°C)	Device Marking (4/5)	Samples
TPS22929DDBVR	ACTIVE	SOT-23	DBV	6	3000	RoHS & Green	NIPDAU	Level-1-260C-UNLIM	-40 to 85	(NF4F, NF4W)	Samples
TPS22929DDBVT	ACTIVE	SOT-23	DBV	6	250	RoHS & Green	NIPDAU	Level-1-260C-UNLIM	-40 to 85	(NF4F, NF4W)	Samples

(1) The marketing status values are defined as follows:

ACTIVE: Product device recommended for new designs.

LIFEBUY: TI has announced that the device will be discontinued, and a lifetime-buy period is in effect.

NRND: Not recommended for new designs. Device is in production to support existing customers, but TI does not recommend using this part in a new design.

PREVIEW: Device has been announced but is not in production. Samples may or may not be available.

OBSOLETE: TI has discontinued the production of the device.

(2) **RoHS:** TI defines "RoHS" to mean semiconductor products that are compliant with the current EU RoHS requirements for all 10 RoHS substances, including the requirement that RoHS substance do not exceed 0.1% by weight in homogeneous materials. Where designed to be soldered at high temperatures, "RoHS" products are suitable for use in specified lead-free processes. TI may reference these types of products as "Pb-Free".

RoHS Exempt: TI defines "RoHS Exempt" to mean products that contain lead but are compliant with EU RoHS pursuant to a specific EU RoHS exemption.

Green: TI defines "Green" to mean the content of Chlorine (Cl) and Bromine (Br) based flame retardants meet JS709B low halogen requirements of <=1000ppm threshold. Antimony trioxide based flame retardants must also meet the <=1000ppm threshold requirement.

(3) MSL, Peak Temp. - The Moisture Sensitivity Level rating according to the JEDEC industry standard classifications, and peak solder temperature.

(4) There may be additional marking, which relates to the logo, the lot trace code information, or the environmental category on the device.

(5) Multiple Device Markings will be inside parentheses. Only one Device Marking contained in parentheses and separated by a "~" will appear on a device. If a line is indented then it is a continuation of the previous line and the two combined represent the entire Device Marking for that device.

(6) Lead finish/Ball material - Orderable Devices may have multiple material finish options. Finish options are separated by a vertical ruled line. Lead finish/Ball material values may wrap to two lines if the finish value exceeds the maximum column width.

Important Information and Disclaimer:The information provided on this page represents TI's knowledge and belief as of the date that it is provided. TI bases its knowledge and belief on information provided by third parties, and makes no representation or warranty as to the accuracy of such information. Efforts are underway to better integrate information from third parties. TI has taken and continues to take reasonable steps to provide representative and accurate information but may not have conducted destructive testing or chemical analysis on incoming materials and chemicals. TI and TI suppliers consider certain information to be proprietary, and thus CAS numbers and other limited information may not be available for release.

In no event shall TI's liability arising out of such information exceed the total purchase price of the TI part(s) at issue in this document sold by TI to Customer on an annual basis.

TAPE AND REEL INFORMATION

QUADRANT ASSIGNMENTS FOR PIN 1 ORIENTATION IN TAPE

*All dimensions are nominal

Device	Package Type	Package Drawing	Pins	SPQ	Reel Diameter (mm)	Reel Width W1 (mm)	A0 (mm)	B0 (mm)	K0 (mm)	P1 (mm)	W (mm)	Pin1 Quadrant
TPS22929DDBVR	SOT-23	DBV	6	3000	178.0	9.0	3.23	3.17	1.37	4.0	8.0	Q3
TPS22929DDBVT	SOT-23	DBV	6	250	178.0	9.0	3.23	3.17	1.37	4.0	8.0	Q3

TAPE AND REEL BOX DIMENSIONS



*All dimensions are nominal

Device	Package Type	Package Drawing	Pins	SPQ	Length (mm)	Width (mm)	Height (mm)
TPS22929DDBVR	SOT-23	DBV	6	3000	180.0	180.0	18.0
TPS22929DDBVT	SOT-23	DBV	6	250	180.0	180.0	18.0



PACKAGE OUTLINE

DBV0006A

SOT-23 - 1.45 mm max height

SMALL OUTLINE TRANSISTOR

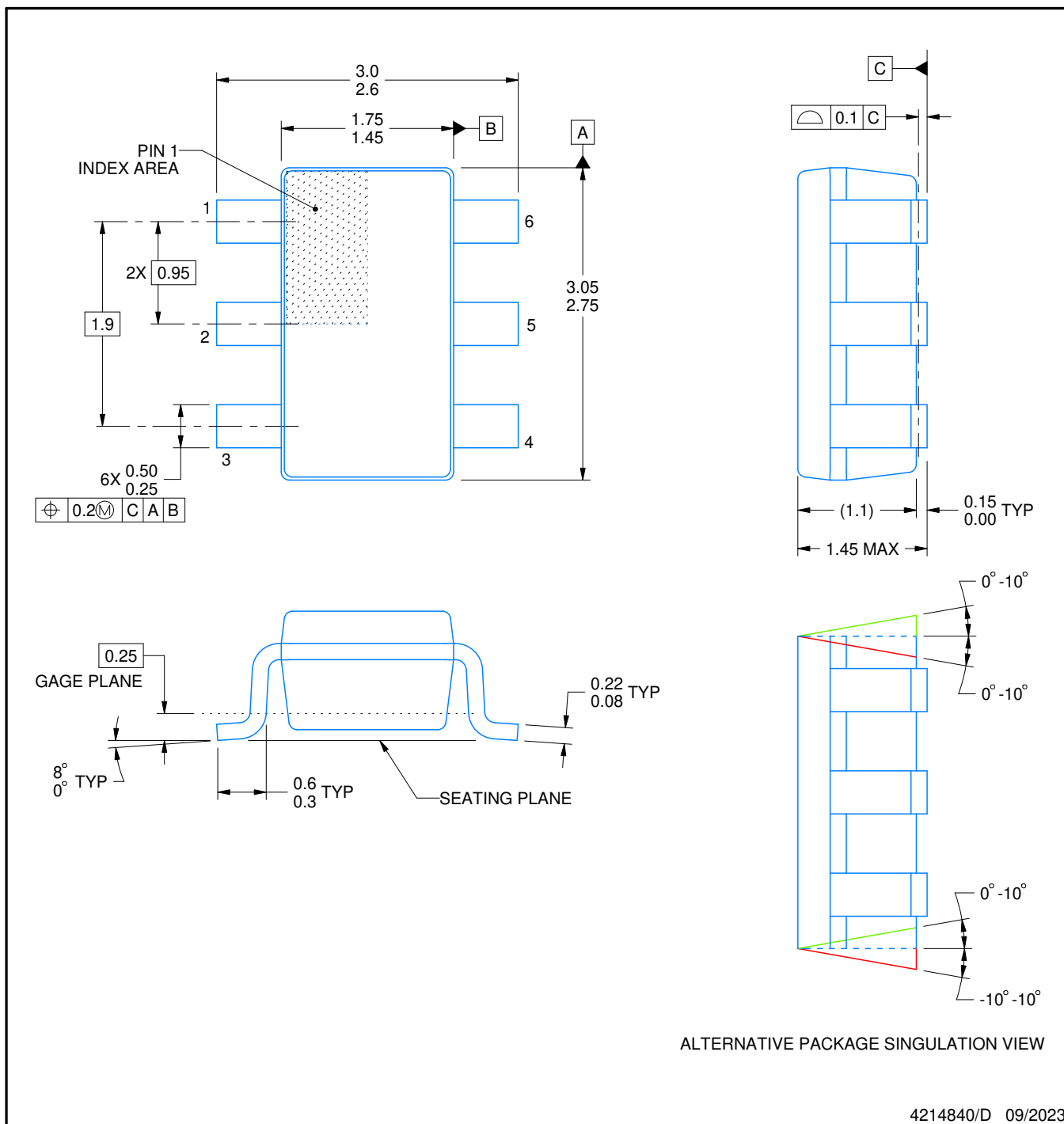

ALTERNATIVE PACKAGE SINGULATION VIEW

4214840/D 09/2023

NOTES:

1. All linear dimensions are in millimeters. Any dimensions in parenthesis are for reference only. Dimensioning and tolerancing per ASME Y14.5M.
2. This drawing is subject to change without notice.
3. Body dimensions do not include mold flash or protrusion. Mold flash and protrusion shall not exceed 0.25 per side.
4. Leads 1,2,3 may be wider than leads 4,5,6 for package orientation.
5. Reference JEDEC MO-178.

EXAMPLE BOARD LAYOUT

DBV0006A

SOT-23 - 1.45 mm max height

SMALL OUTLINE TRANSISTOR

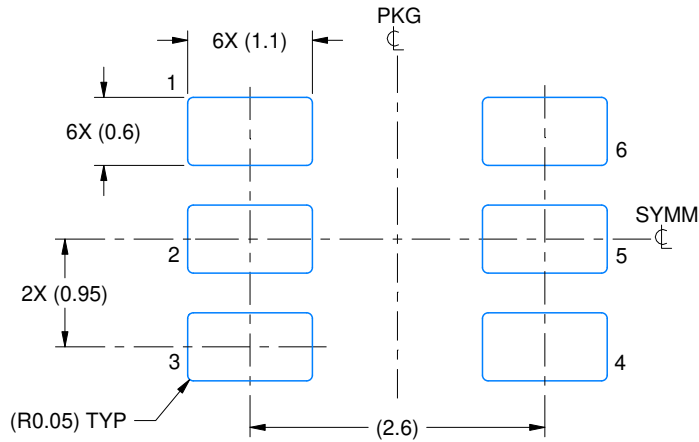

LAND PATTERN EXAMPLE
EXPOSED METAL SHOWN
SCALE:15X

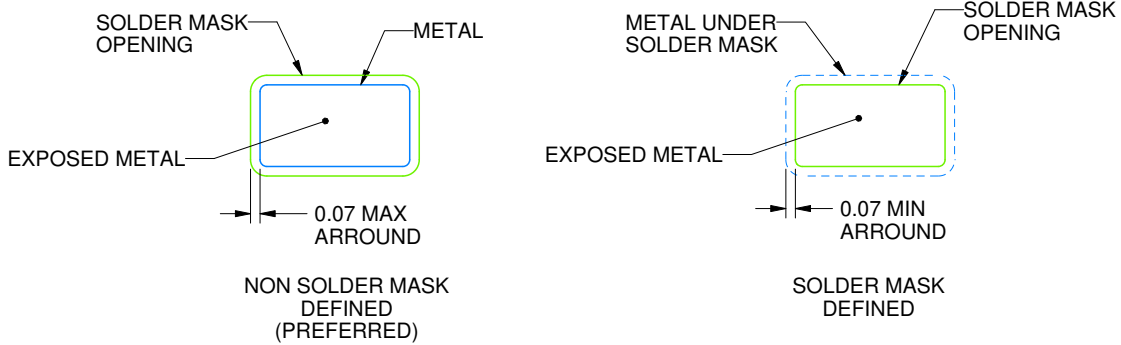

SOLDER MASK DETAILS

4214840/D 09/2023

NOTES: (continued)

- 6. Publication IPC-7351 may have alternate designs.
- 7. Solder mask tolerances between and around signal pads can vary based on board fabrication site.

EXAMPLE STENCIL DESIGN

DBV0006A

SOT-23 - 1.45 mm max height

SMALL OUTLINE TRANSISTOR

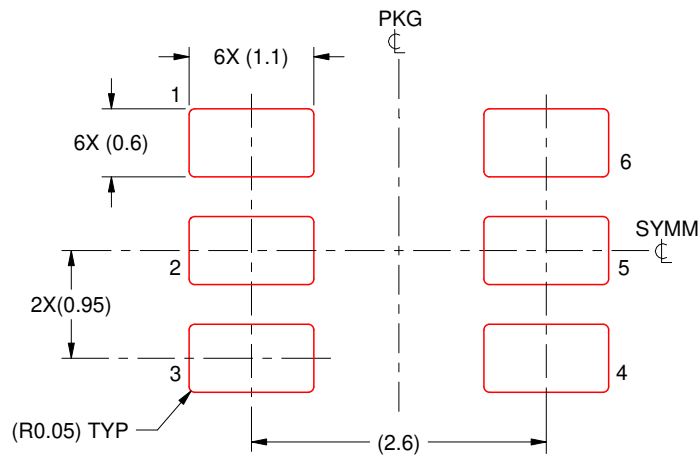

SOLDER PASTE EXAMPLE
BASED ON 0.125 mm THICK STENCIL
SCALE:15X

4214840/D 09/2023

NOTES: (continued)

8. Laser cutting apertures with trapezoidal walls and rounded corners may offer better paste release. IPC-7525 may have alternate design recommendations.
9. Board assembly site may have different recommendations for stencil design.

IMPORTANT NOTICE AND DISCLAIMER

TI PROVIDES TECHNICAL AND RELIABILITY DATA (INCLUDING DATA SHEETS), DESIGN RESOURCES (INCLUDING REFERENCE DESIGNS), APPLICATION OR OTHER DESIGN ADVICE, WEB TOOLS, SAFETY INFORMATION, AND OTHER RESOURCES "AS IS" AND WITH ALL FAULTS, AND DISCLAIMS ALL WARRANTIES, EXPRESS AND IMPLIED, INCLUDING WITHOUT LIMITATION ANY IMPLIED WARRANTIES OF MERCHANTABILITY, FITNESS FOR A PARTICULAR PURPOSE OR NON-INFRINGEMENT OF THIRD PARTY INTELLECTUAL PROPERTY RIGHTS.

These resources are intended for skilled developers designing with TI products. You are solely responsible for (1) selecting the appropriate TI products for your application, (2) designing, validating and testing your application, and (3) ensuring your application meets applicable standards, and any other safety, security, regulatory or other requirements.

These resources are subject to change without notice. TI grants you permission to use these resources only for development of an application that uses the TI products described in the resource. Other reproduction and display of these resources is prohibited. No license is granted to any other TI intellectual property right or to any third party intellectual property right. TI disclaims responsibility for, and you will fully indemnify TI and its representatives against, any claims, damages, costs, losses, and liabilities arising out of your use of these resources.

TI's products are provided subject to [TI's Terms of Sale](#) or other applicable terms available either on [ti.com](https://www.ti.com) or provided in conjunction with such TI products. TI's provision of these resources does not expand or otherwise alter TI's applicable warranties or warranty disclaimers for TI products.

TI objects to and rejects any additional or different terms you may have proposed.

Mailing Address: Texas Instruments, Post Office Box 655303, Dallas, Texas 75265
Copyright © 2023, Texas Instruments Incorporated