

Bulk Metal® Foil Technology RNC90Y and RNC90Z (Z-Foil) to MIL-PRF-55182/9



INTRODUCTION

Military Established Reliability resistors from Vishay Foil Resistors (VFR) are available in resistance values from 4.99 Ω through 121 k Ω and with tolerances from $\pm 0.005\%$ to $\pm 1.0\%$. The same resistors are also available as non-qualified products for customers desiring higher or lower resistance values and the same or better performance capabilities (see Table 2). Both qualified and non-qualified versions are manufactured on the same production line facilities and are subjected to the same process, lot control, conditioning, and GRP A (100%) screening. Qualified versions receive additional MIL Group B and C testing.

The RNC90Y has been the benchmark for high-precision, established-reliability discrete resistors since 1982. In 2000, VFR engineers achieved a technological breakthrough with the introduction of the commercial ultra-precision, low-TCR Z201 resistor. This breakthrough allowed for the introduction of a resistor with very low TCR and an “R” reliability level. The RNC90Z TCR limit of ± 2 ppm/ $^{\circ}\text{C}$ over the extended range of -55°C to $+175^{\circ}\text{C}$ is a significant improvement over the existing RNC90Y specification.

The RNC90Z is a direct replacement for the RNC90Y.

FEATURES

- QPL product with established reliability (ER)
- “R” level high reliability resistor qualified to MIL-PRF-55182/9
- Load life stability: $\pm 0.05\%$ ΔR for 2000 h, 0.3 W at $+125^{\circ}\text{C}$
- Temperature coefficient of resistance (TCR): ± 2 ppm/ $^{\circ}\text{C}$ max. (-55°C to $+175^{\circ}\text{C}$)
- Resistance tolerance: to $\pm 0.005\%$
- Thermal EMF: < 0.1 $\mu\text{V}/^{\circ}\text{C}$
- Qualified resistance range: 4.99 Ω to 121 k Ω (RNC90Y)
30.1 Ω to 121 k Ω (RNC90Z)
- Specially conditioned non-QPL resistors available
See data sheet “Improved Performance Tested”
- Fast thermal stabilization
- Electrostatic discharge (ESD) above 25 000 V
- Non inductive, non capacitive design
- Current noise < -42 dB
- Prototype sample available

FIGURE 1 - COMPARISON OF RNC90Y TO RNC90Z TEMPERATURE COEFFICIENT OF RESISTANCE

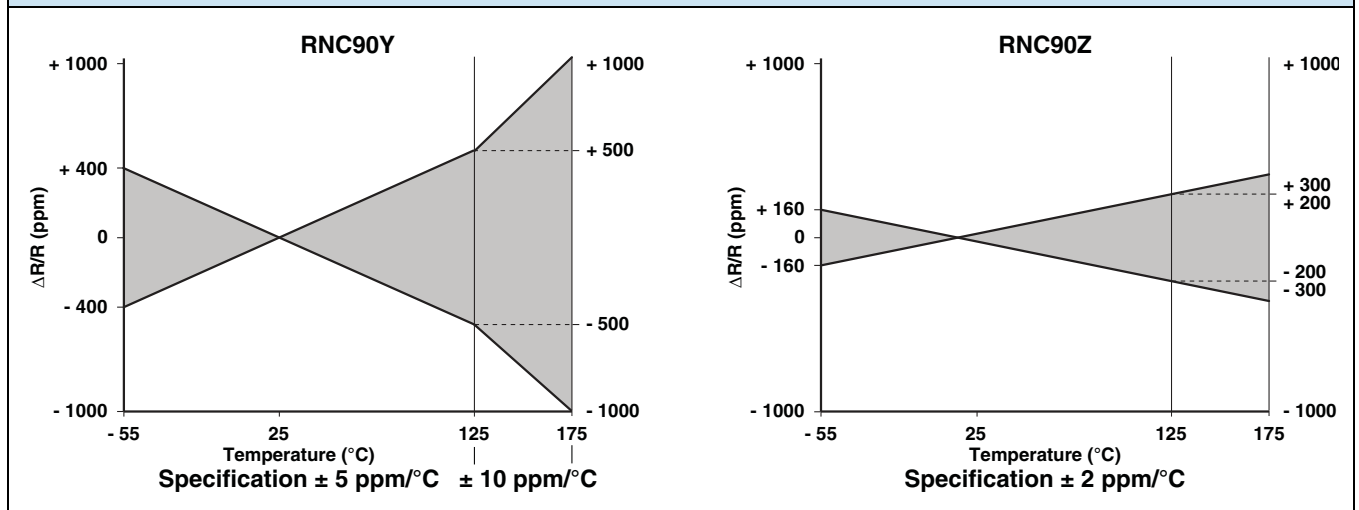

TABLE 1 - SPECIFICATIONS COMPARISON ⁽¹⁾				
SPECIFICATION	RNC90Y (QUALIFIED) MIL-PRF-55182/9 CHARACTERISTIC Y LIMITS	RNC90Z (QUALIFIED) MIL-PRF-55182/9 CHARACTERISTIC Z LIMITS	S555 (NON-QUALIFIED) VFR PERFORMANCE LIMITS	Z555 (NON-QUALIFIED) VFR PERFORMANCE LIMITS
Temperature Coefficient of Resistance	± 5 ppm/°C (- 55 °C to + 125 °C) ± 10 ppm/°C (+ 125 °C to + 175 °C)	± 2 ppm/°C (- 55 °C to + 175 °C)	± 5 ppm/°C (- 55 °C to + 125 °C)	± 3 ppm/°C ± 2.5 ppm/°C ± 2 ppm/°C (- 55 °C to + 125 °C)
Resistance Range	4.99 Ω to 121 kΩ	30.1 Ω to 121 kΩ	1 Ω to 150 kΩ	4.99 Ω to 25 Ω > 25 Ω to 80 Ω > 80 Ω
Failure Rate	Level R	Level R	Not specified	Not specified
Load-Life Stability 0.3 W at + 125 °C at 2000 h at 10 000 h	± 0.05 % maximum ΔR ± 0.5 % maximum ΔR	± 0.05 % maximum ΔR ± 0.5 % maximum ΔR	± 0.015 % maximum ΔR ⁽²⁾ ± 0.05 % maximum ΔR ⁽²⁾	± 0.015 % maximum ΔR ⁽²⁾ ± 0.05 % maximum ΔR ⁽²⁾
Current Noise	Not specified	Not specified	- 40 dB minimum	- 40 dB minimum
High-Frequency Operation Rise Time Inductance ⁽³⁾ (L) Capacitance (C)	Not specified Not specified Not specified	Not specified Not specified Not specified	1.0 ns at 1 kΩ 0.1 μH maximum 0.08 μH typical 1.0 pF maximum 0.5 pF typical	1.0 ns at 1 kΩ 0.1 μH maximum 0.08 μH typical 1.0 pF maximum 0.5 pF typical
Voltage Coefficient	0.0005 %/V	0.0005 %/V	0.0001 %/V	0.0001 %/V
Working Voltage ⁽⁴⁾	300 V maximum	300 V maximum	300 V maximum	300 V maximum
Thermal EMF ⁽⁵⁾	Not specified	Not specified	0.1 μV/°C maximum 1 μV/W maximum	0.1 μV/°C maximum 1 μV/W maximum

Notes

- (1) Qualification and failure rate verification test data is maintained by Vishay Foil Resistors and is available upon request. Lot traceability and identification data is maintained by VFR for 7 years.
- (2) Load life ΔR Maximum can be reduced by 80 % through a screening procedure. Consult our Applications Engineering for details.
- (3) Inductance (L) due mainly to the leads.
- (4) Not to exceed power rating of resistor.
- (5) μV/°C relates to EMF due to lead temperature differences and μV/W due to power applied to the resistor.

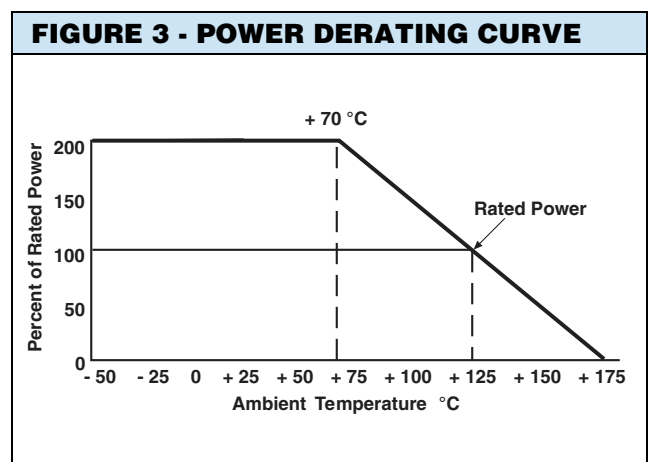
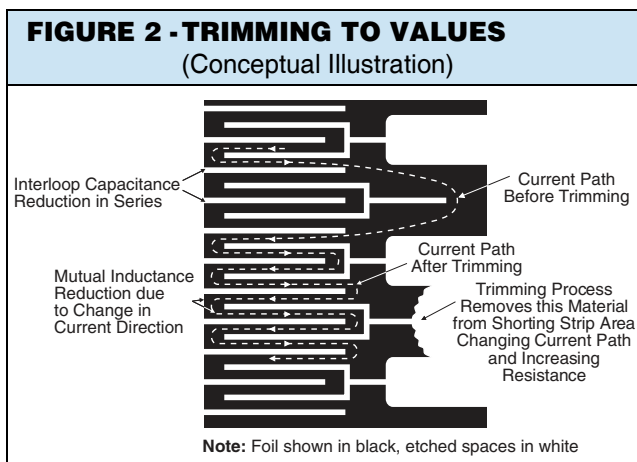

FIGURE 4 - IMPRINTING AND DIMENSIONS

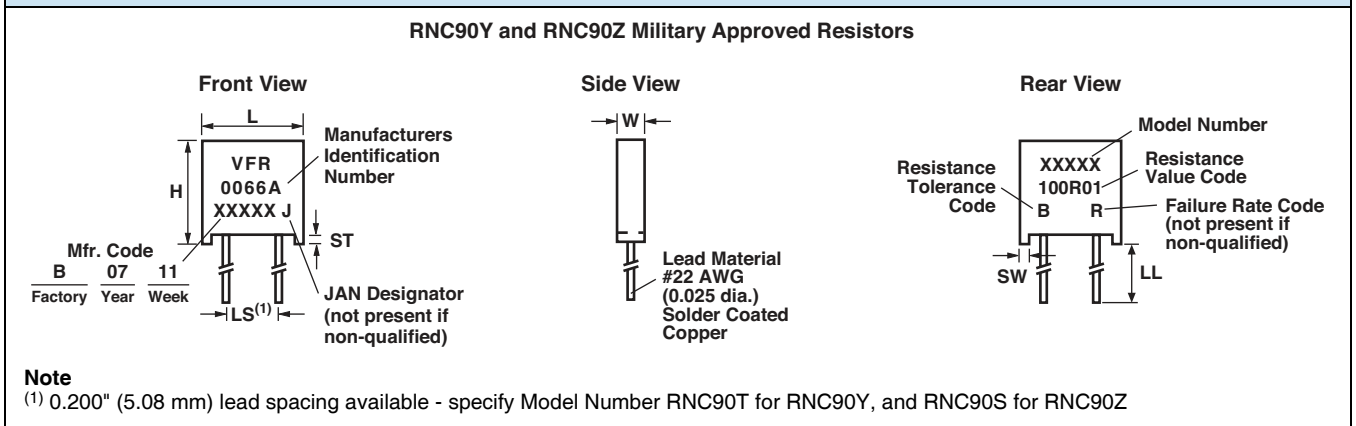

TABLE 2 - MODEL SELECTION

MODEL NUMBER	RESISTANCE RANGE (Ω)	STANDARD RESISTANCE TOLERANCE		FAILURE RATE	AMBIENT POWER RATING		AVERAGE WEIGHT (g)	DIMENSIONS	
		TIGHTEST %	LOOSEST %		at + 70 °C	at + 125 °C		INCHES	mm
RNC90Y	30.1 to 121K 16.2 to 30.0 4.99 to 16.0	± 0.005 ± 0.05 ± 0.1	± 1.0 ± 1.0 ± 1.0	M, P, R (See Table 3)	0.6 W	0.3 W	0.6	W: 0.105 ± 0.010 L: 0.300 ± 0.010 H: 0.326 ± 0.010 ST: 0.015 ± 0.005 SW: 0.040 ± 0.005 LL: 1.000 ± 0.125 LS: 0.150 ± 0.005	2.67 ± 0.25 7.62 ± 0.25 8.28 ± 0.25 0.38 ± 0.13 1.02 ± 0.13 25.4 ± 3.18 3.81 ± 0.13
RNC90Z	30.1 to 121K	± 0.005	± 1.0		0.6 W	0.3 W			
S555 (NON QPL)	30.1 to 121K	± 0.005	± 1.0	-	0.6 W	0.3 W	0.6		
	20 to < 30.1	± 0.01	± 1.0						
	5 to < 20	± 0.05	± 1.0						
> 121K to 150K	2 to < 5	± 0.1	± 1.0	-	0.4 W	0.2 W	0.6		
	1 to < 2	± 0.5	± 1.0						
Z555 (NON QPL)	30.1 to 121K	± 0.005	± 1.0	-	0.6 W	0.3 W	0.6		
	20 to < 30.1	± 0.01	± 1.0						
	4.99 to < 20R	± 0.05	± 1.0						

Note

S555 and Z555 units are manufactured on the same production line facilities and are subjected to all the same process and lot control requirements imposed on RNC90Y (Z) version, as well as all of the special screening, environmental conditioning and documentation stipulations outlined in MIL-PRF 55182/9

TABLE 3 - GLOBAL PART NUMBER INFORMATION

NEW GLOBAL PART NUMBER: Y1189100R500AR0L (preferred part number format)

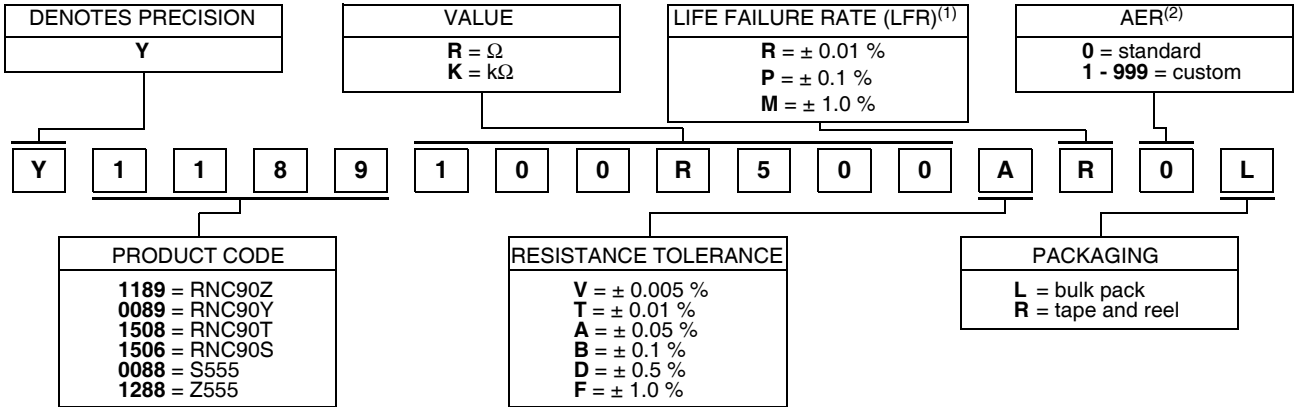

FOR EXAMPLE: ABOVE GLOBAL ORDER Y1189 100R500 A R 0 L:

TYPE: RNC90Z
 VALUE: 100.5 Ω
 ABSOLUTE TOLERANCE: $\pm 0.05\%$
 LIFE FAILURE RATE (LFR): $\pm 0.01\%$
 AER: standard
 PACKAGING: bulk pack

HISTORICAL PART NUMBER: RNC90Z 100R50 A R B (will continue to be used)

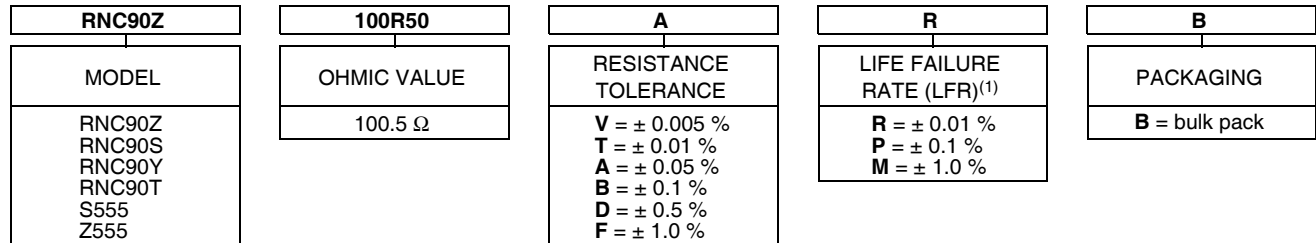

Note

- (1) Applicable only for QPL part. For S555 and Z555 please assign "0" instead.
- (2) For non-standard requests, please contact application engineering.

CAGE #0066A
 “Commercial and Government Entity”
 Formerly “FSCM”

The response of military and non military grade resistors to environmental stresses can be made better by “Improved Performance Testing” (IPT). The IPT part will see burn-in and cycling that removes the “knee” from the normal drift of non IPT parts. (See Table 4 for the improvement to expect in military parts when calling for VFR recommended screening). Users should be aware that IPT testing renders the part non QPL and so a 3XXXXX part number will be assigned by VFR. Consult Applications Engineering for details and ordering advice.

TABLE 4 - IMPROVED PERFORMANCE TESTING (NON-QPL) VS. QPL

TEST GROUP	TEST	RNC90Y MIL-PRF-55182 & MIL-PRF-55182/9		VISHAY FOIL RESISTORS IMPROVED PERFORMANCE TESTING (IPT) LIMITS
		METHOD PARAGRAPH	LIMITS	
I	Burn-in	4.8.3.3	± 0.05 %	± 0.0025 %
	Thermal Shock and Overload Combined	4.8.2 4.8.3	- ± 0.05 %	- ± 0.005 %
	Resistance Temperature Characteristic	4.8.9	± 5 ppm/°C	< ± 2 ppm/°C (- 55 °C to + 125 °C) (Can be sorted for tighter tracking)
II	Low Temperature Storage	4.8.23	± 0.05 %	± 0.0025 %
	Low Temperature Operation	4.8.10	± 0.05 %	± 0.0025 %
	Terminal Strength	4.8.11	± 0.02 %	± 0.001 %
III	DWV	4.8.12	± 0.02 %	± 0.001 %
	Insulation Resistance	4.8.13	10 ⁴ MΩ	> 10 ⁴ MΩ
	Resistance to Soldering Heat	4.8.14	± 0.02 %	± 0.001 %
	Moisture Resistance	4.8.15	± 0.05 %	± 0.015 %
IV	Shock	4.8.16	± 0.01 %	± 0.0025 %
	Vibration	4.8.17	± 0.02 %	± 0.0025 %
V	Load Life at + 125 °C; 2000 h	4.8.18	± 0.05 %	± 0.005 % (50 ppm)
	Load Life at + 125 °C; 10 000 h	4.8.18	± 0.5 %	± 0.015 % (150 ppm)
V (a)	+ 85 °C Power Rating	-	-	± 0.005 % (50 ppm)
	+ 70 °C Power Rating	4.8.18	± 0.05 %	± 0.005 % (50 ppm)
V (b)	+ 25 °C Power Rating	-	-	± 0.005 % (50 ppm)
VI	Storage Life	-	-	± 0.0025 %
VII	High Temperature Exposure	4.8.19	± 0.5 %	± 0.005 %
VIII	Max. Allowance Reactance	-	-	< 1 %
	Current Noise	-	-	< - 42 dB
	Voltage Coefficient	4.8.20	0.0005 %/V (5 ppm/V)	< 0.00001 %/V (< 0.1 ppm/V)
	Thermal EMF	-	-	0.1 μV/°C

FIGURE 5 - IPT IMPRINTING AND DIMENSIONS in inches (millimeters)

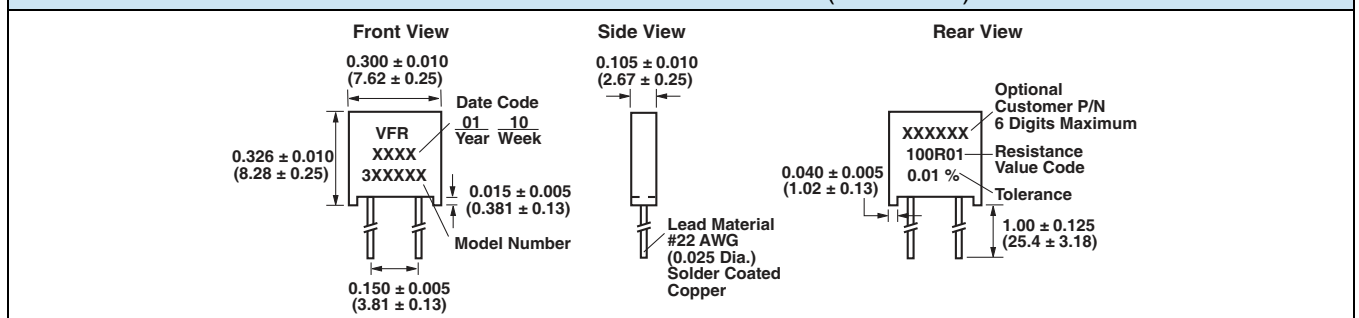



Disclaimer

ALL PRODUCTS, PRODUCT SPECIFICATIONS AND DATA ARE SUBJECT TO CHANGE WITHOUT NOTICE.

Vishay Precision Group, Inc., its affiliates, agents, and employees, and all persons acting on its or their behalf (collectively, "VPG"), disclaim any and all liability for any errors, inaccuracies or incompleteness contained herein or in any other disclosure relating to any product.

The product specifications do not expand or otherwise modify VPG's terms and conditions of purchase, including but not limited to, the warranty expressed therein.

VPG makes no warranty, representation or guarantee other than as set forth in the terms and conditions of purchase. **To the maximum extent permitted by applicable law, VPG disclaims (i) any and all liability arising out of the application or use of any product, (ii) any and all liability, including without limitation special, consequential or incidental damages, and (iii) any and all implied warranties, including warranties of fitness for particular purpose, non-infringement and merchantability.**

Information provided in datasheets and/or specifications may vary from actual results in different applications and performance may vary over time. Statements regarding the suitability of products for certain types of applications are based on VPG's knowledge of typical requirements that are often placed on VPG products. It is the customer's responsibility to validate that a particular product with the properties described in the product specification is suitable for use in a particular application. You should ensure you have the current version of the relevant information by contacting VPG prior to performing installation or use of the product, such as on our website at vpgsensors.com.

No license, express, implied, or otherwise, to any intellectual property rights is granted by this document, or by any conduct of VPG.

The products shown herein are not designed for use in life-saving or life-sustaining applications unless otherwise expressly indicated. Customers using or selling VPG products not expressly indicated for use in such applications do so entirely at their own risk and agree to fully indemnify VPG for any damages arising or resulting from such use or sale. Please contact authorized VPG personnel to obtain written terms and conditions regarding products designed for such applications.

Product names and markings noted herein may be trademarks of their respective owners.

Copyright Vishay Precision Group, Inc., 2014. All rights reserved.