

**DG0598**  
**Demo Guide**  
**SmartFusion2 Dual-Axis Motor Control Starter Kit**



**Power Matters.™**

**Microsemi Corporate Headquarters**

One Enterprise, Aliso Viejo,  
CA 92656 USA

Within the USA: +1 (800) 713-4113

Outside the USA: +1 (949) 380-6100

Fax: +1 (949) 215-4996

Email: [sales.support@microsemi.com](mailto:sales.support@microsemi.com)

[www.microsemi.com](http://www.microsemi.com)

© 2016 Microsemi Corporation. All rights reserved. Microsemi and the Microsemi logo are trademarks of Microsemi Corporation. All other trademarks and service marks are the property of their respective owners.

Microsemi makes no warranty, representation, or guarantee regarding the information contained herein or the suitability of its products and services for any particular purpose, nor does Microsemi assume any liability whatsoever arising out of the application or use of any product or circuit. The products sold hereunder and any other products sold by Microsemi have been subject to limited testing and should not be used in conjunction with mission-critical equipment or applications. Any performance specifications are believed to be reliable but are not verified, and Buyer must conduct and complete all performance and other testing of the products, alone and together with, or installed in, any end-products. Buyer shall not rely on any data and performance specifications or parameters provided by Microsemi. It is the Buyer's responsibility to independently determine suitability of any products and to test and verify the same. The information provided by Microsemi hereunder is provided "as is, where is" and with all faults, and the entire risk associated with such information is entirely with the Buyer. Microsemi does not grant, explicitly or implicitly, to any party any patent rights, licenses, or any other IP rights, whether with regard to such information itself or anything described by such information. Information provided in this document is proprietary to Microsemi, and Microsemi reserves the right to make any changes to the information in this document or to any products and services at any time without notice.

**About Microsemi**

Microsemi Corporation (Nasdaq: MSCC) offers a comprehensive portfolio of semiconductor and system solutions for aerospace & defense, communications, data center and industrial markets. Products include high-performance and radiation-hardened analog mixed-signal integrated circuits, FPGAs, SoCs and ASICs; power management products; timing and synchronization devices and precise time solutions, setting the world's standard for time; voice processing devices; RF solutions; discrete components; enterprise storage and communication solutions, security technologies and scalable anti-tamper products; Ethernet solutions; Power-over-Ethernet ICs and midspans; as well as custom design capabilities and services. Microsemi is headquartered in Aliso Viejo, California, and has approximately 4,800 employees globally. Learn more at [www.microsemi.com](http://www.microsemi.com).

# Contents

---

<b>1</b>	<b>Revision History</b>	<b>1</b>
1.1	Revision 7.0	1
1.2	Revision 6.0	1
1.3	Revision 5.0	1
1.4	Revision 4.0	1
1.5	Revision 3.0	1
1.6	Revision 2.0	1
1.7	Revision 1.0	1
<b>2</b>	<b>SmartFusion2 Dual-Axis Motor Control Starter Kit</b>	<b>2</b>
2.1	Introduction	2
2.2	Design Requirements	2
2.3	Demo Design	2
2.4	Demo Design Features	3
2.5	Setting Up the Demo Design	3
2.5.1	Setting Up the Hardware	3
2.5.2	Installing the Motor Control GUI	4
2.6	Running the Demo Design	12
2.7	Running the BLDC Motors	14
2.8	Running Stepper Motors	20
2.8.1	Continuous Mode	21
2.8.2	Position Mode	21
2.9	Register Dump Feature	24
<b>3</b>	<b>Appendix: Jumper Settings</b>	<b>28</b>
<b>4</b>	<b>Appendix: Connecting the Motor Terminals</b>	<b>29</b>
4.1	BLDC Motor Connections	29
4.1.1	Stepper Motor Connections	30

# Figures

---

Figure 1	SmartFusion2 Dual Axis Motor Control Demo Hardware Setup	3
Figure 2	Identifying the SmartFusion2 Motor Control Kit USB Driver	5
Figure 3	Device Manager	6
Figure 4	Installing the USB Driver - Opening the Properties Window	7
Figure 5	Selecting the Right VID Number in the Properties Window	8
Figure 6	Updating Driver Software	8
Figure 7	Updating Driver Software - Locate and Install the Driver Software Manually	9
Figure 8	Updating Driver Software - Selecting the Driver Location	9
Figure 9	Model Selection	10
Figure 10	Windows Security Dialog	10
Figure 11	Successful Installation Message	11
Figure 12	Verifying the Installed Driver Software	11
Figure 13	Launching the SmartFusion2 Dual-Axis Motor Control GUI	12
Figure 14	SmartFusion2 Motor Control GUI - Launch Window	13
Figure 15	SmartFusion2 Motor Control GUI - BLDC Motor Screen	14
Figure 16	Configuring Motor Parameters Window	15
Figure 17	Motor Specifications Configuration Window	15
Figure 18	SmartFusion2 Motor Control GUI - Run or Stop All Motors	16
Figure 19	SmartFusion2 Motor Control GUI - Start Plotting	17
Figure 20	Plot Waveforms Window	17
Figure 21	Plot Waveforms Window with Options	18
Figure 22	SmartFusion2 Motor Control GUI - Displaying Speed and Current	19
Figure 23	SmartFusion2 Motor Control GUI - Saving and Loading Waveforms	20
Figure 24	SmartFusion2 Motor Control GUI - Stepper Motor Window	21
Figure 25	SmartFusion2 Motor Control GUI - Stepper Motor in Position Mode	22
Figure 26	Configure Stepper Motor Parameters Window	23
Figure 27	Register Dump window	24
Figure 28	Register Dump window—BLDC Tab	25
Figure 29	Register Dump window—Stepper Tab	26
Figure 30	Sample Csv File	27
Figure 31	Jumpers on SmartFusion2 Starter Kit	28
Figure 32	Wiring Diagram for BLDC Motor Connectors	29
Figure 33	Wiring Diagram for Stepper Motor Connectors	30

# Tables

---

Table 1	Design Requirements .....	2
Table 2	Jumper Settings on the SmartFusion2 Starter Kit Board .....	28

# 1 Revision History

---

The revision history describes the changes that were implemented in the document. The changes are listed by revision, starting with the current publication.

## 1.1 Revision 7.0

The following is a summary of changes made in revision 7.0 of this document.

- [Design Requirements](#), page 2 was edited to change the version of Libero SoC to v11.8 SP2 and the version of Microsemi Motor Control GUI to v5.8.
- Programming files and GUI files links were edited in [Demo Design](#), page 2 with respect to Libero v11.8 SP2 release.

## 1.2 Revision 6.0

The following is a summary of the changes made in revision 6.0 of this document.

- Added new section [Register Dump Feature](#), page 24.
- Updated the document for Libero v11.7 software release.

## 1.3 Revision 5.0

Updated the document for GUI v5.3 release (SAR 75167).

## 1.4 Revision 4.0

The following is a summary of the changes in revision 4.0 of this document.

- Updated the document for GUI v5.2 release (SAR 72926).
- Updated the document for Libero v11.6 software release (SAR 72926).

## 1.5 Revision 3.0

Added [Appendix: Connecting the Motor Terminals](#), page 29 (SAR 69108).

## 1.6 Revision 2.0

Updated [Table 2](#), page 28 and added [Figure 31](#), page 28 to update jumper settings (SAR 66381).

## 1.7 Revision 1.0

Revision 1.0 was the first publication of this document.

## 2 SmartFusion2 Dual-Axis Motor Control Starter Kit

### 2.1 Introduction

The SmartFusion<sup>®</sup>2 Dual-Axis Motor Control Starter Kit gives designers a starting point to evaluate time-saving and proven motor control reference designs. The kit is supplied with the hardware IP blocks and software. A fully integrated solution along with a powerful and easy to use GUI that enables designers to quickly prototype the design is also provided. The kit helps designers in customizing and developing dual-axis motor control solution on the SmartFusion2 device for a specific application and reduces time-to-market. This document provides details about the hardware setup and connections for running the demo design.

### 2.2 Design Requirements

The following table lists the hardware and software requirements for this demo design.

**Table 1 • Design Requirements**

Design Requirements	Description
<b>Hardware</b>	
SmartFusion2 Dual-Axis Motor Control Starter Kit board (SF2-MC-STARTER-KIT-SA) with SOM	–
FlashPro4 programmer or later	–
Brush less DC (BLDC) motor (QBL4208-41-04-006)	One
Stepper motor (QSH4218-35-10-027)	One
USB A to mini-B USB cable	–
Power adapter (ETSA240270UDC-P5P-SZ)	24 V
Operating System	Any 64-bit or 32-bit Windows 7 or Later Operating System
<b>Software</b>	
Libero <sup>®</sup> System-on-Chip (SoC)	v11.8 SP2
Microsemi Motor Control GUI	v5.8
USB drivers for GUI	–
FlashPro programming software	v11.8 SP2

### 2.3 Demo Design

The programming files are available for download at:

[http://soc.microsemi.com/download/rsc/?f=m2s\\_dg0598\\_liberov11p8sp2\\_pf](http://soc.microsemi.com/download/rsc/?f=m2s_dg0598_liberov11p8sp2_pf)

The programming files include:

- Programming File
- readme.txt

The GUI installers are available for download at:

[http://soc.microsemi.com/download/rsc/?f=m2s\\_dg0598\\_liberov11p8sp2\\_gui](http://soc.microsemi.com/download/rsc/?f=m2s_dg0598_liberov11p8sp2_gui)

The GUI installer files include:

- GUI installer
- readme.txt

For the first time users, the GUI and drivers should be installed. The GUI can be installed using the GUI installer and the drivers can be installed using the instructions provided in [GUI Driver Configuration](#), page 5. If a previous version of the GUI is installed, then SF2 Dual Axis Motor Control GUI.exe file must be executed to run the GUI.

## 2.4 Demo Design Features

The demo design runs:

- A single permanent-magnet synchronous motor (PMSM) using sensor less field oriented control (FOC) algorithm
- A single stepper motor using the micro-stepping algorithm

The GUI provided with the demo is used to configure and control the motors. The GUI can also plot certain debug variables and display motor speed and current values.

## 2.5 Setting Up the Demo Design

The following sections describe how to setup the demo design.

### 2.5.1 Setting Up the Hardware

The following figure shows the hardware setup for one BLDC motor in sensorless FOC and a stepper motor in FOC.

**Figure 1 • SmartFusion2 Dual Axis Motor Control Demo Hardware Setup**

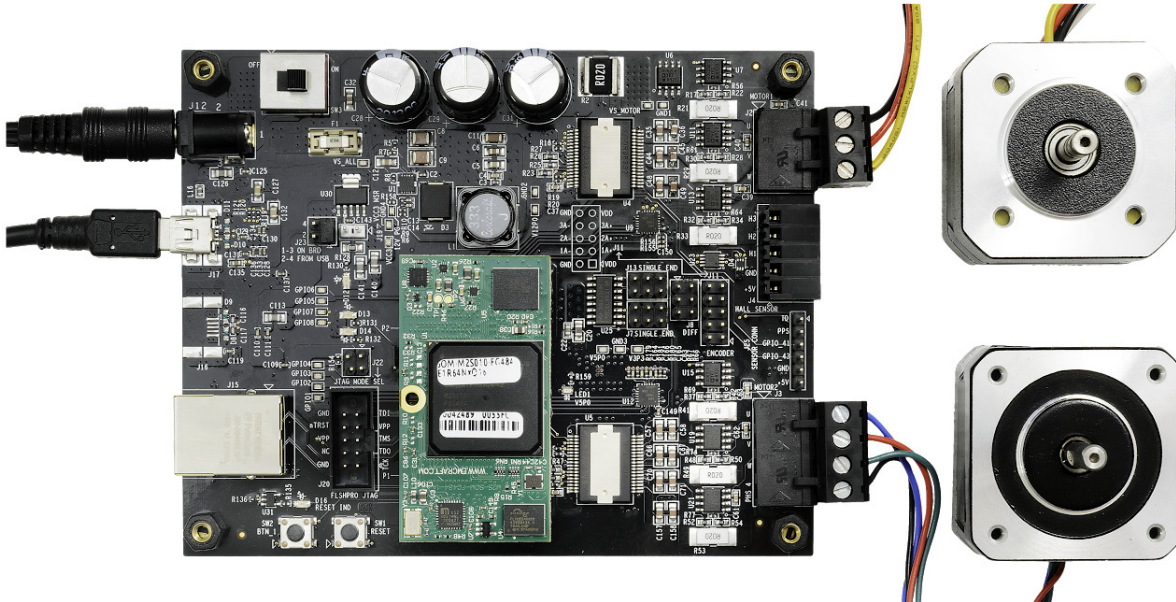



### 2.5.1.1 Connecting the Board

The following steps describe how to connect the board:

1. Connect the 24 V power supply to **J12** connector.
2. Connect the BLDC motor (QBL4208-41-04-006) to **J2** connector.
  - Black wire - U-Phase of the motor
  - Red wire - V-Phase of the motor
  - Yellow wire - W-Phase of the motor
3. Connect the Stepper motor (QSH4218-35-10-027) to **J3** connector.
  - Black wire - A1 of the motor to be connected to PHS4
  - Green wire - A2 of the motor to be connected to W
  - Red wire - B1 of the motor to be connected to V
  - Blue wire - B2 of the motor to be connected to U
4. Set the required jumpers on the board. For information on jumper settings, see [Table 2](#), page 28.
5. Switch **ON** the power supply switch, **SW3**.
6. Connect the FlashPro JTAG to the FP header.
7. Open the FlashPro software and program the STAPL file (SK2ABLSLST10\_5\_2.stp).
8. Power cycle the board using **SW3**.

### 2.5.2 Installing the Motor Control GUI

The following steps describe how to install the motor control GUI:

1. Go to the GUI folder and run `setup.exe`.
2. Click **Yes** for any message from User Account Control. Setup window is displayed with the default locations.
3. Click **Next**.
  - a. Accept the license agreement and click **Next**.
  - b. Confirm the installation location in the installation dialog box and click **Next**.A progress bar appears that shows the progress of the installation.  
On successful installation, **Installation Complete** message is displayed.
4. Click **Finish** to exit the installation wizard.
5. Restart the host PC.
6. Check the device manager to see, if the USB drivers are already configured on the host machine.
7. Check if the drivers are configured correctly, after ensuring that the hardware is powered **ON** and connected to the host PC using USB cable (**J17** connector on board).

8. Check if **NI-VISA USB devices** appears in the device manager as shown in the following figure. If they are configured, skip to [Running the Demo Design](#), page 12.

**Figure 2 • Identifying the SmartFusion2 Motor Control Kit USB Driver**

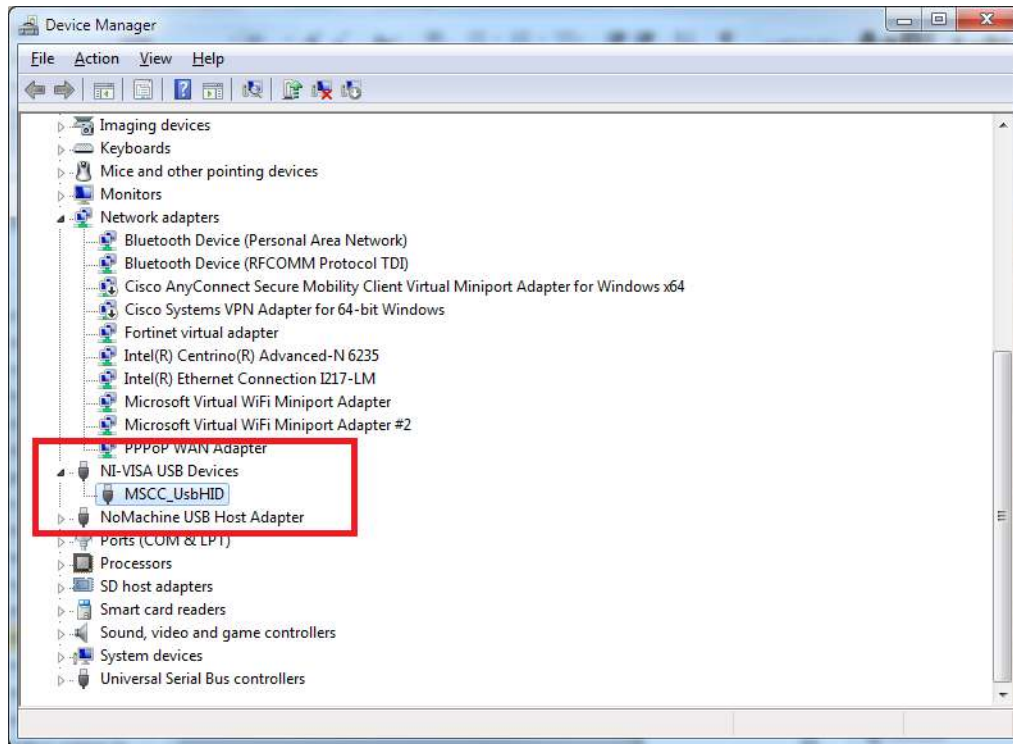

### 2.5.2.1 GUI Driver Configuration

The following steps describe how to install the GUI driver on the host PC that has Windows 7 or above installed. The downloaded programming file must be programmed on the board before proceeding for driver installation.

1. Connect the host PC to the **J17** connector on the SmartFusion2 Motor Control Kit using the USB A to mini-B USB cable.
2. Connect the power adapter to the kit and switch **ON** the **SW3** switch.

3. Open Device Manager of the host PC and select **USB Input Device** under **Human Interface Devices**, as shown in the following figure.

**Figure 3 • Device Manager**

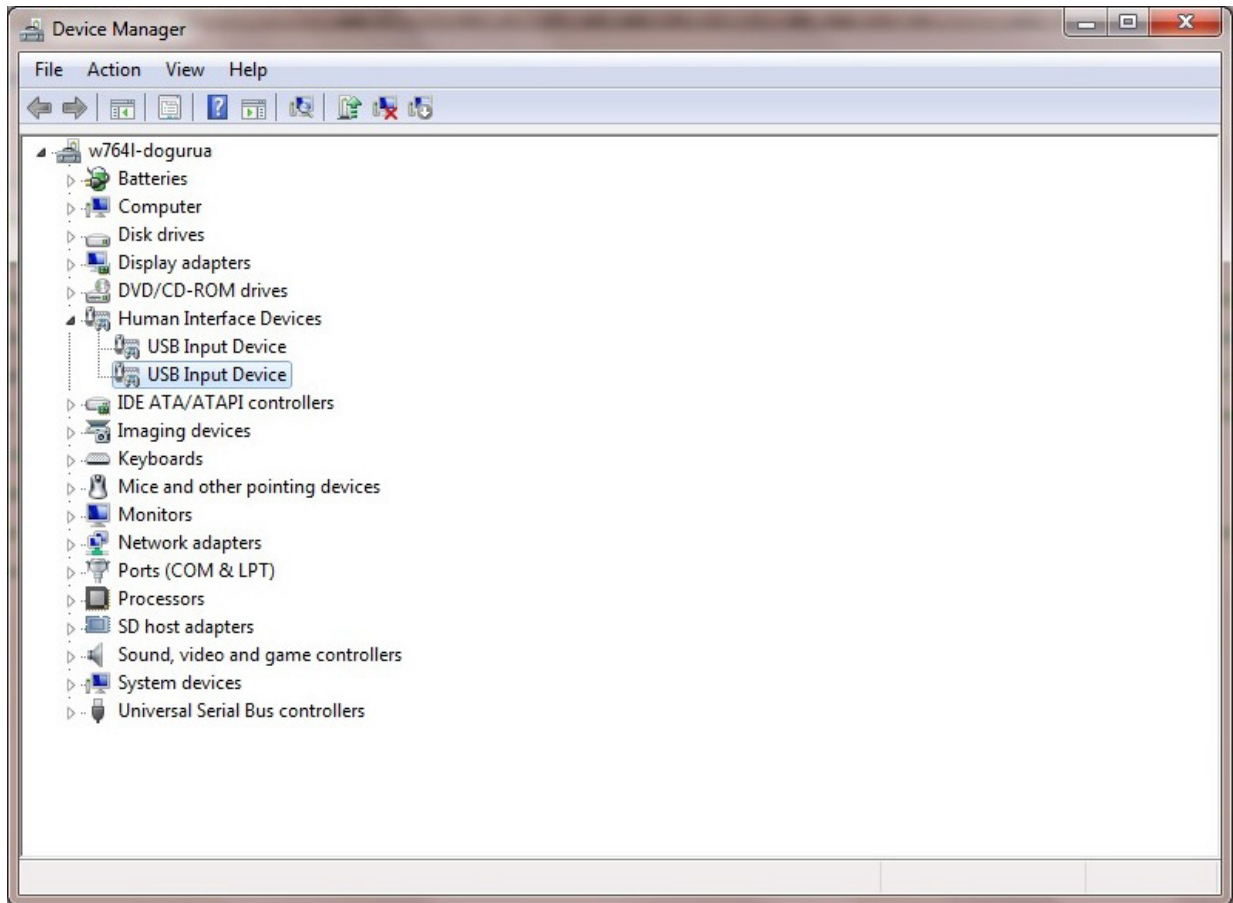

4. Right-click **USB Input Device** and select **Properties**.

**Figure 4 • Installing the USB Driver - Opening the Properties Window**

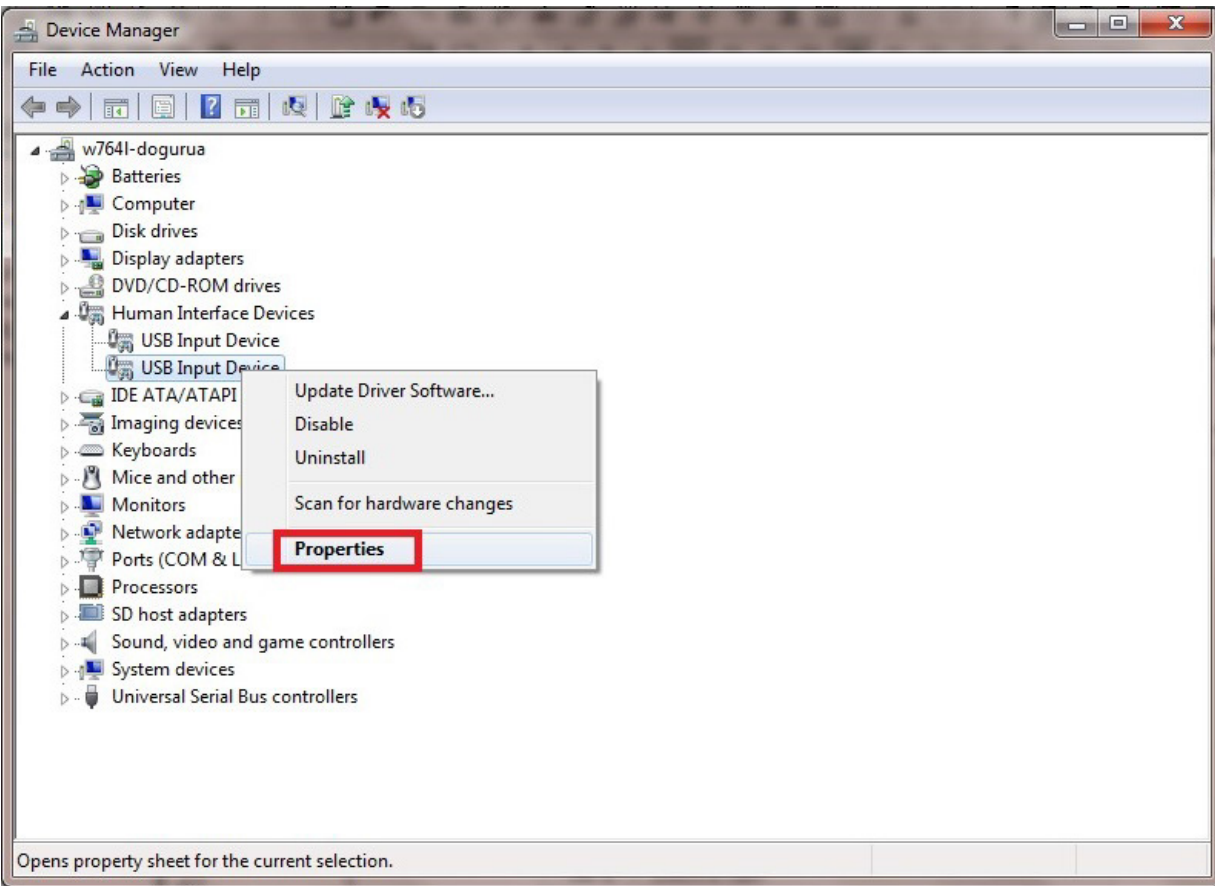

The following figure shows the **USB Input Device Properties** window.

5. In the **Details** tab, select **Hardware Ids** under **Property**.

- Verify that the VID number is 1514. If not, go to Step 3 and select a different device and try again.

**Figure 5 • Selecting the Right VID Number in the Properties Window**

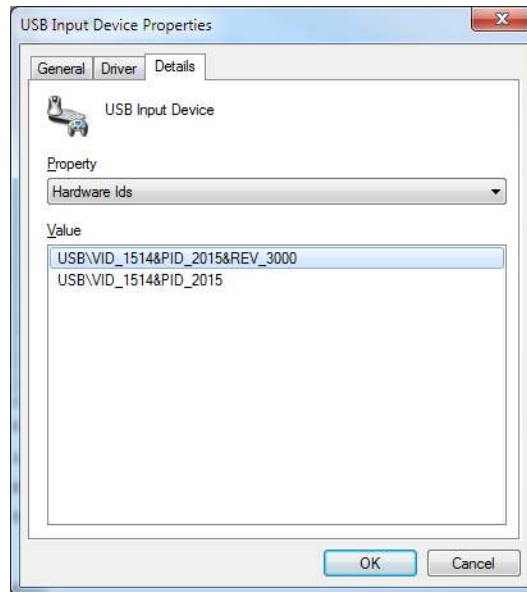

- In the **Device Manager** window, right-click the **USB Input Device** with the specified VID number and select **Update Driver Software**, as shown in the following figure.

**Figure 6 • Updating Driver Software**

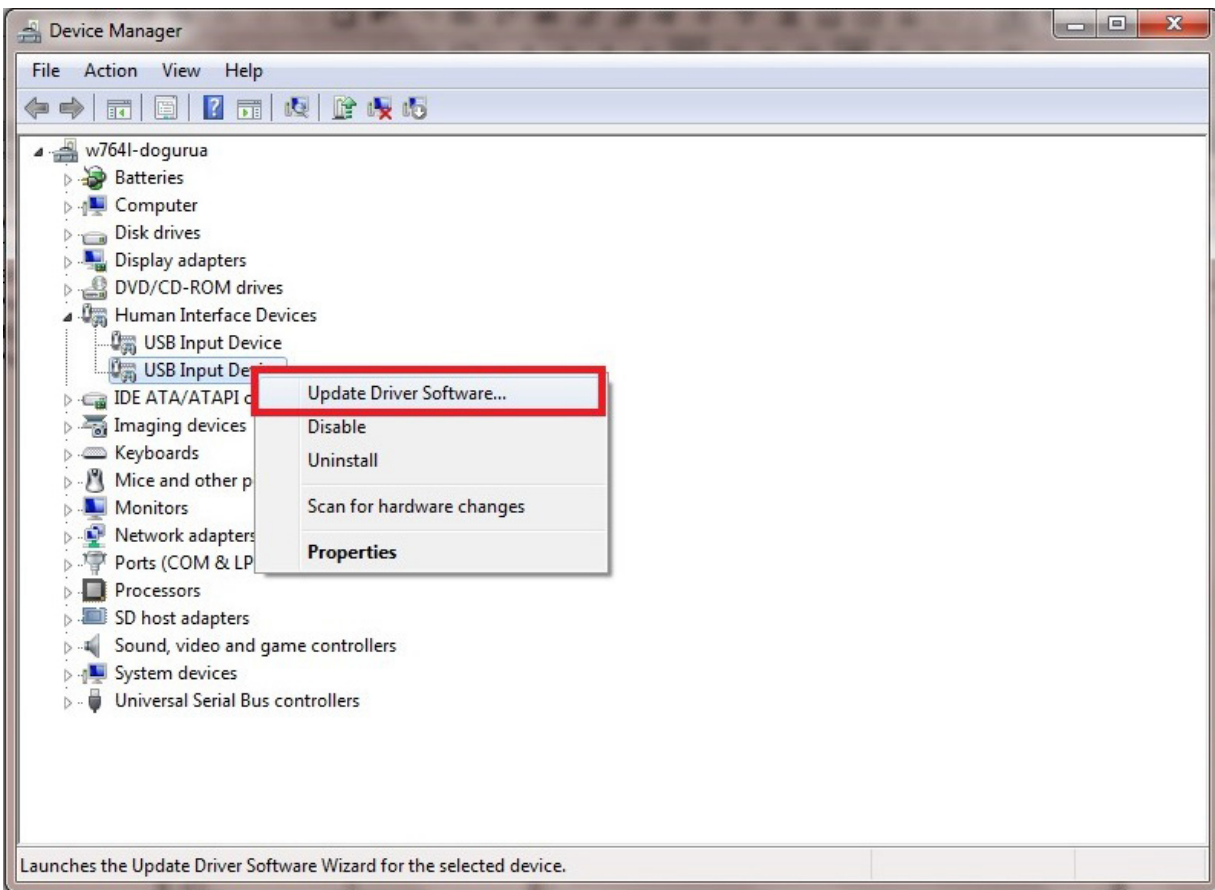

8. Select **Browse my computer for driver software** from the **Update Driver Software - USB Input Device** window.

**Figure 7 • Updating Driver Software - Locate and Install the Driver Software Manually**

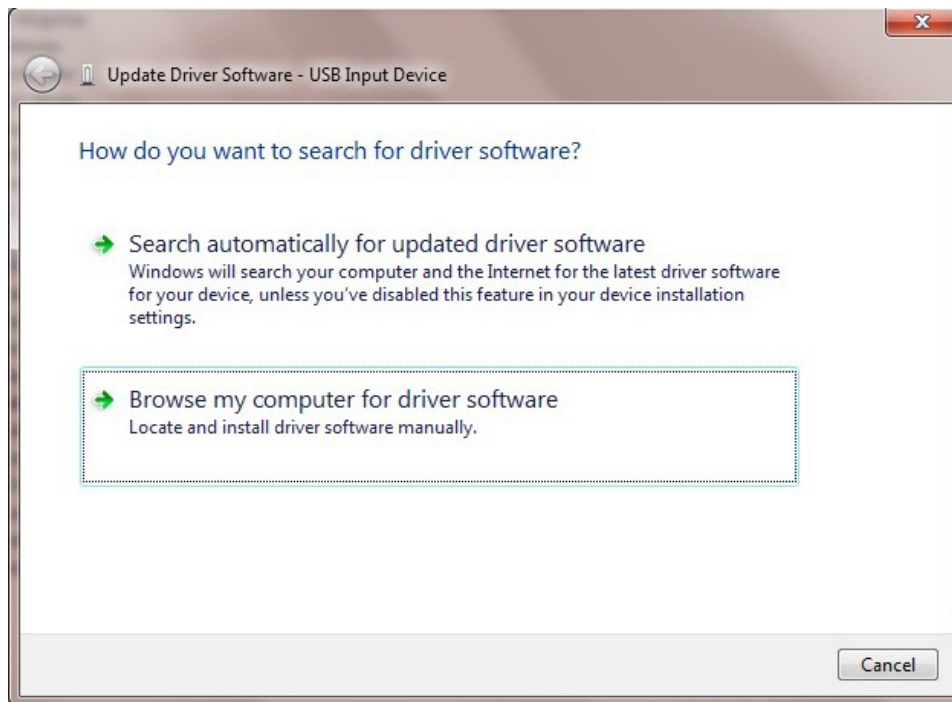

9. Click **Let me pick from a list of device drivers on my computer** and click **Next** as shown in the following figure.

**Figure 8 • Updating Driver Software - Selecting the Driver Location**

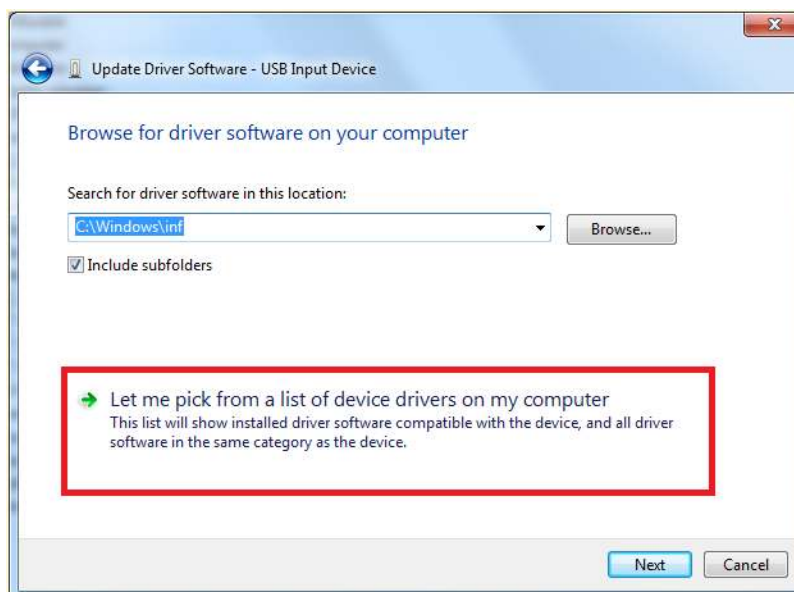

10. Select **MSCC\_UsbHID** and click **Next**.

**Figure 9 • Model Selection**

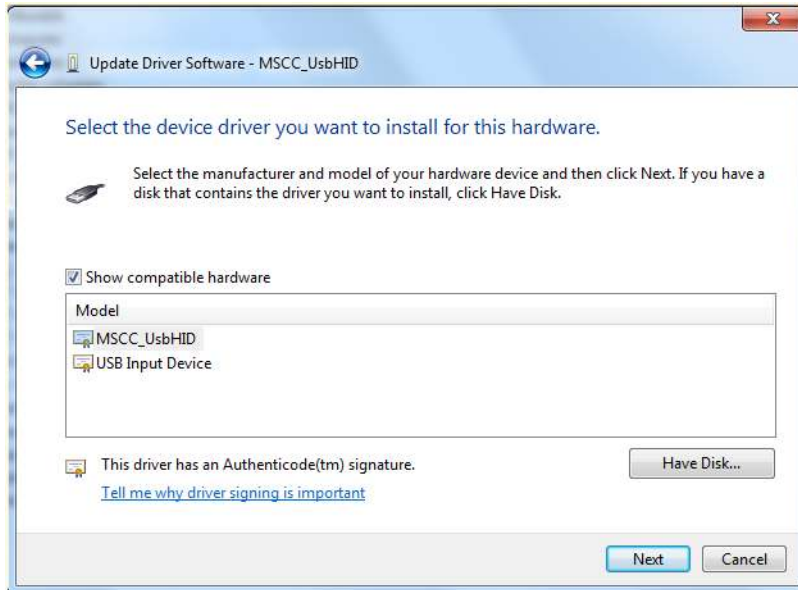

11. Click **Install**.

**Figure 10 • Windows Security Dialog**

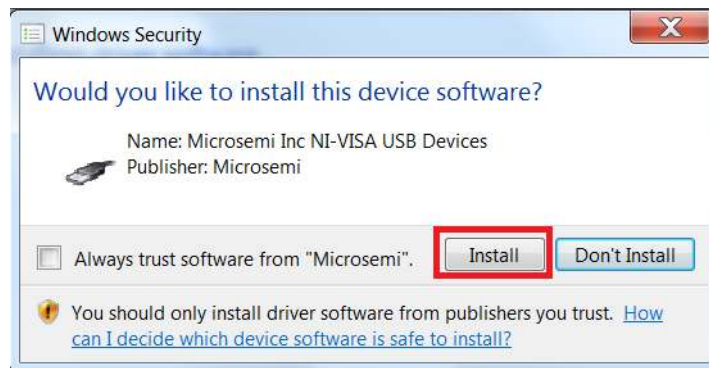



After successful installation, the following window is displayed.

**Figure 11 • Successful Installation Message**

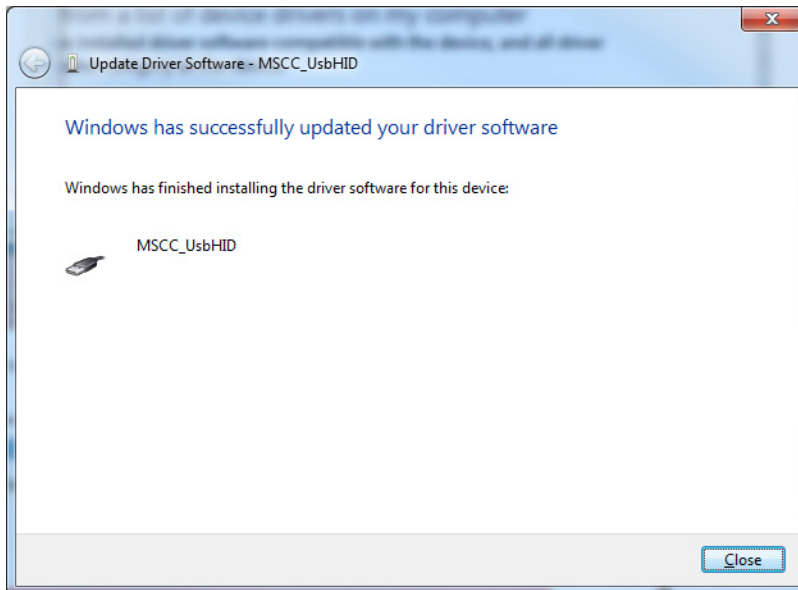

12. Check for **NI-VISA-USB Devices** in the **Device Manager** window to ensure that the driver is installed successfully.

**Figure 12 • Verifying the Installed Driver Software**

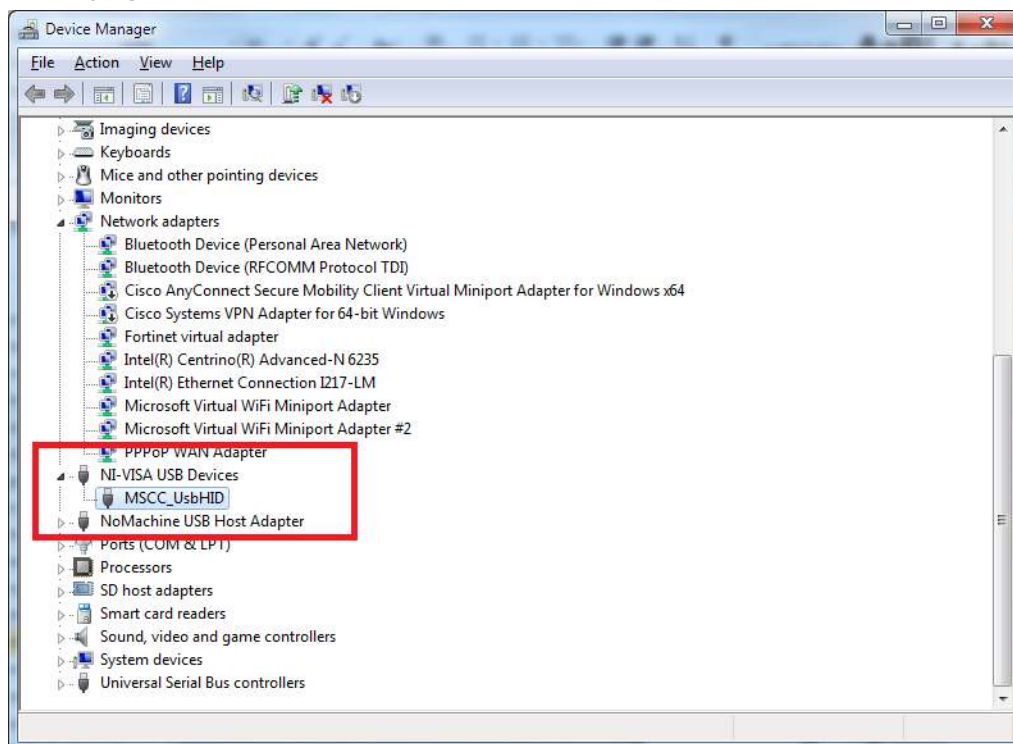



## 2.6 Running the Demo Design

The following steps describe how to run the demo design:

1. After installing the GUI, go to **Start** menu and select **SF2 Dual Axis Motor Control GUI** to open the GUI as shown in the following figure.

**Figure 13 • Launching the SmartFusion2 Dual-Axis Motor Control GUI**

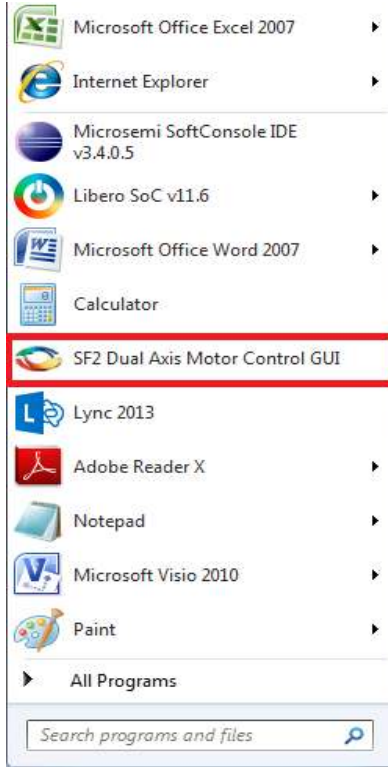

- In the SmartFusion2 Motor Control GUI, select the **USB device** with VID 0x1514 and PID 0x2015 (USB0::0x1514::0x2015..) from the **USB DEVICE** drop-down list.

**Figure 14 • SmartFusion2 Motor Control GUI - Launch Window**

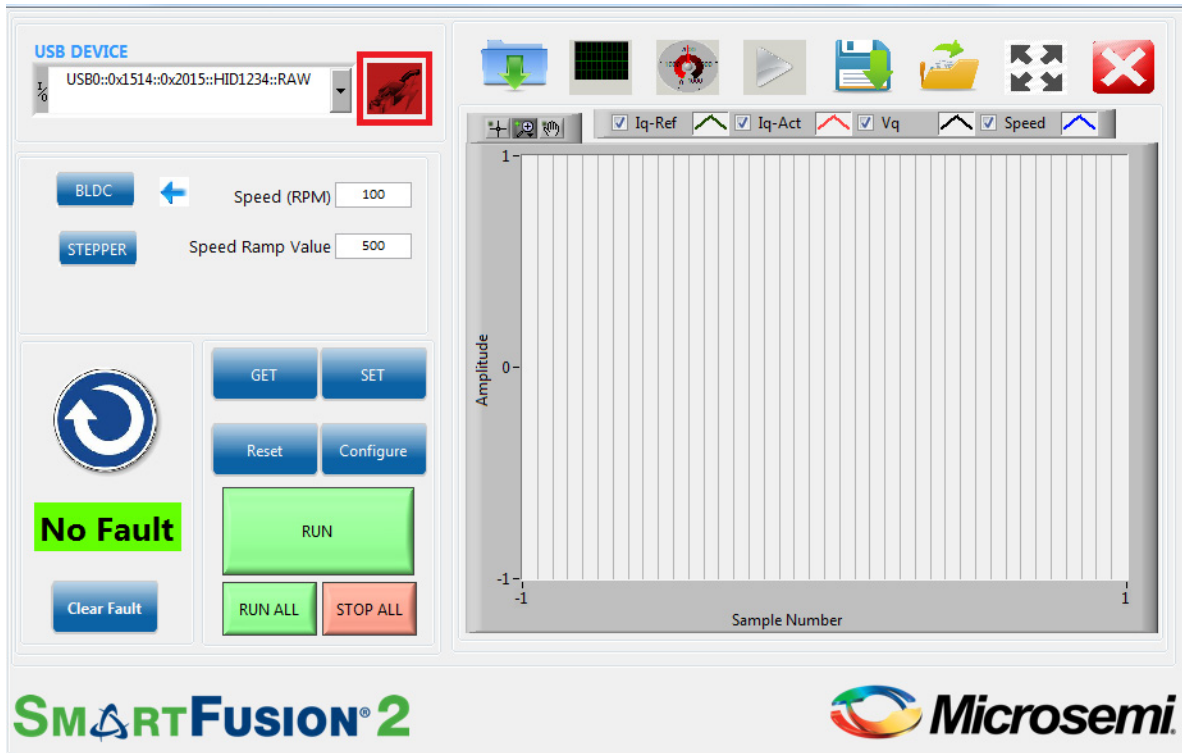

- Click **Connect**. On successful connection, the Connect button (highlighted in Figure 14, page 13) turns green.

## 2.7 Running the BLDC Motors

Use the **GET** and **SET** options to modify or verify the motor speed, motor ramp rate, current and speed loop PI controller parameters, and angle correction PI parameters. Click **Configure** to invoke the **Configure Motor Parameters** window.

Figure 15 • SmartFusion2 Motor Control GUI - BLDC Motor Screen

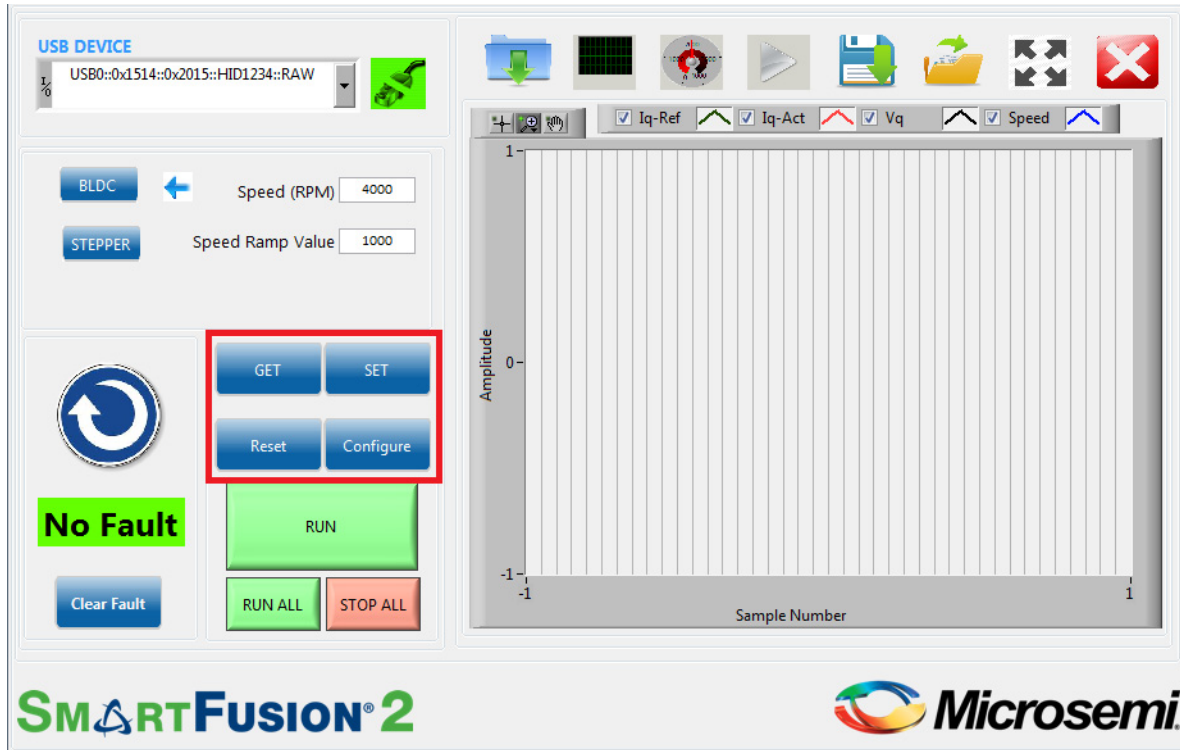

The PI controller parameters (Kp and Ki values) can be modified using the **Configure Motor Parameters** window shown in [Figure 16](#), page 15.

The **Configure Motor Parameters** window allows to change PI controller constants, startup mode, soft stop setting, Closed Loop Speed threshold, Open Loop Current, and Voltage.

On clicking, **Configure Motor Specification** highlighted in the following figure, **Motor Specifications Configuration** window opens, which allows to change the listed parameters.

**Figure 16 • Configuring Motor Parameters Window**

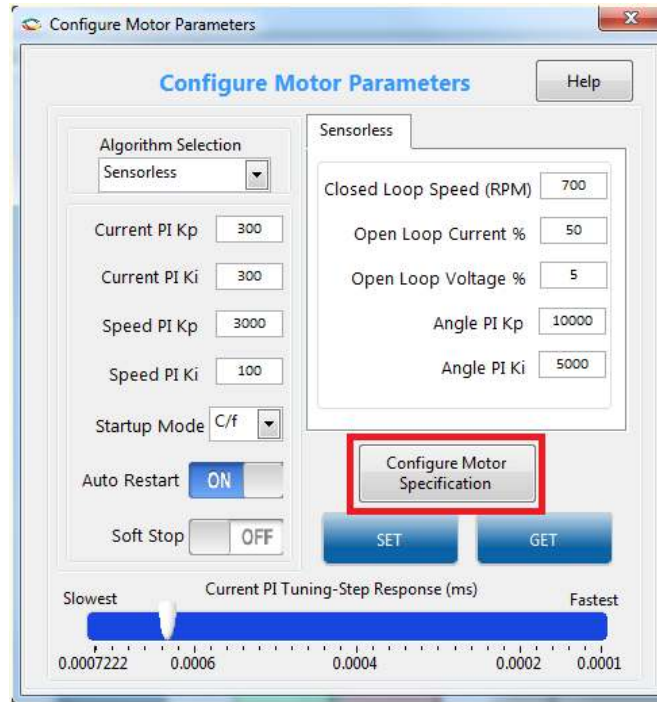

**Figure 17 • Motor Specifications Configuration Window**

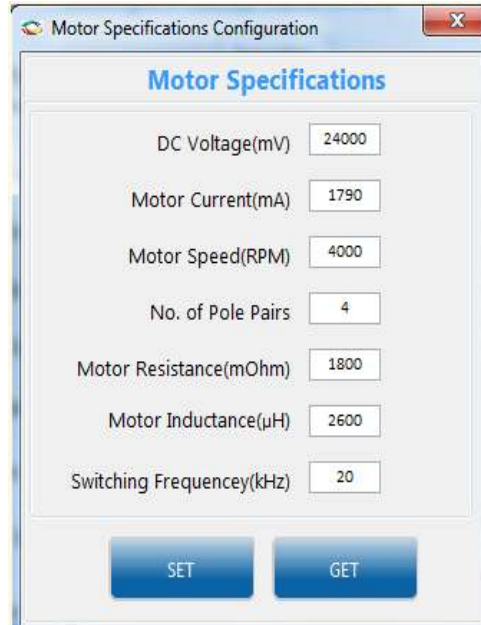

- To modify a parameter, change the required field and click **SET**.
  - To check the data in the hardware corresponding to each parameter, click **GET**.
  - To run the motor, click **RUN** and to stop the motor, click **STOP**.
4. Click **Run All** to run all the motors and click **Stop All** to stop all the running motors. These buttons are highlighted in the following figure.

In the event of a fault occurrence, it is indicated in the indicator above the **Clear Fault** button. To clear a Fault, click **Clear Fault** highlighted in the following figure.

**Figure 18 • SmartFusion2 Motor Control GUI - Run or Stop All Motors**

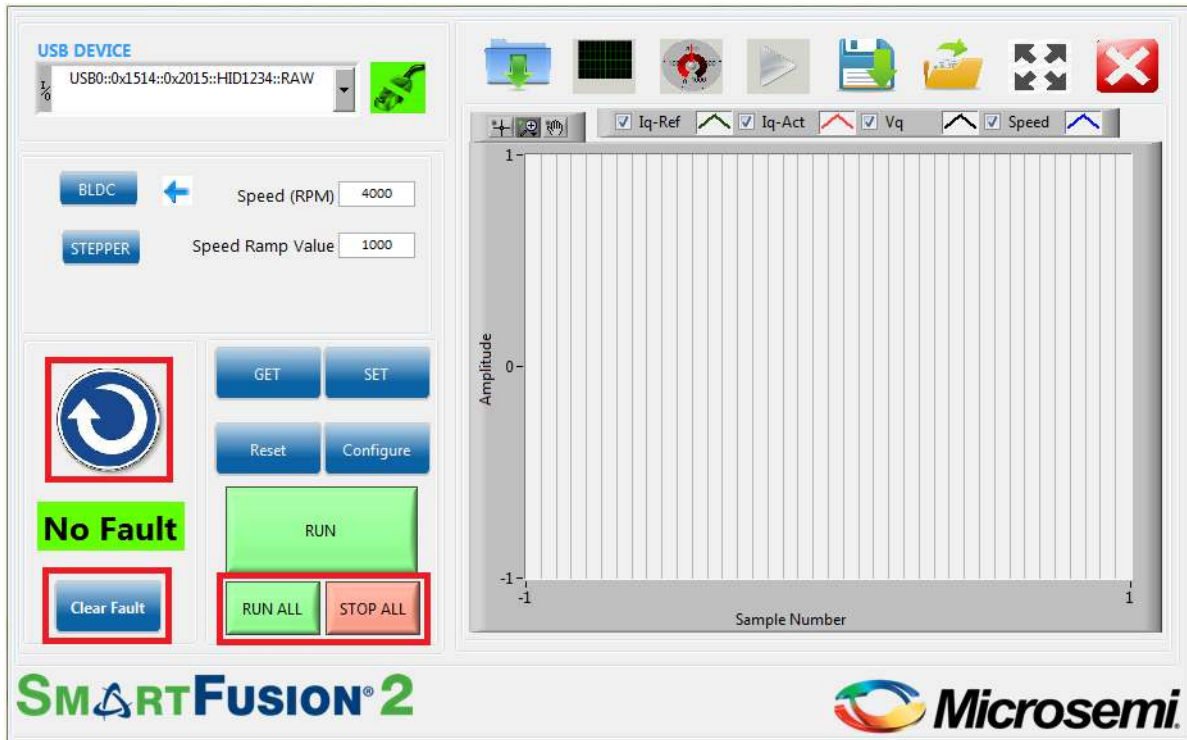

Click **Motor Direction** to set the motor direction. This button also indicates the current motor direction.

- The GUI automatically plots waveforms when motor starts running. The plotting can be paused by clicking the pause button highlighted in the following figure.

**Figure 19 • SmartFusion2 Motor Control GUI - Start Plotting**

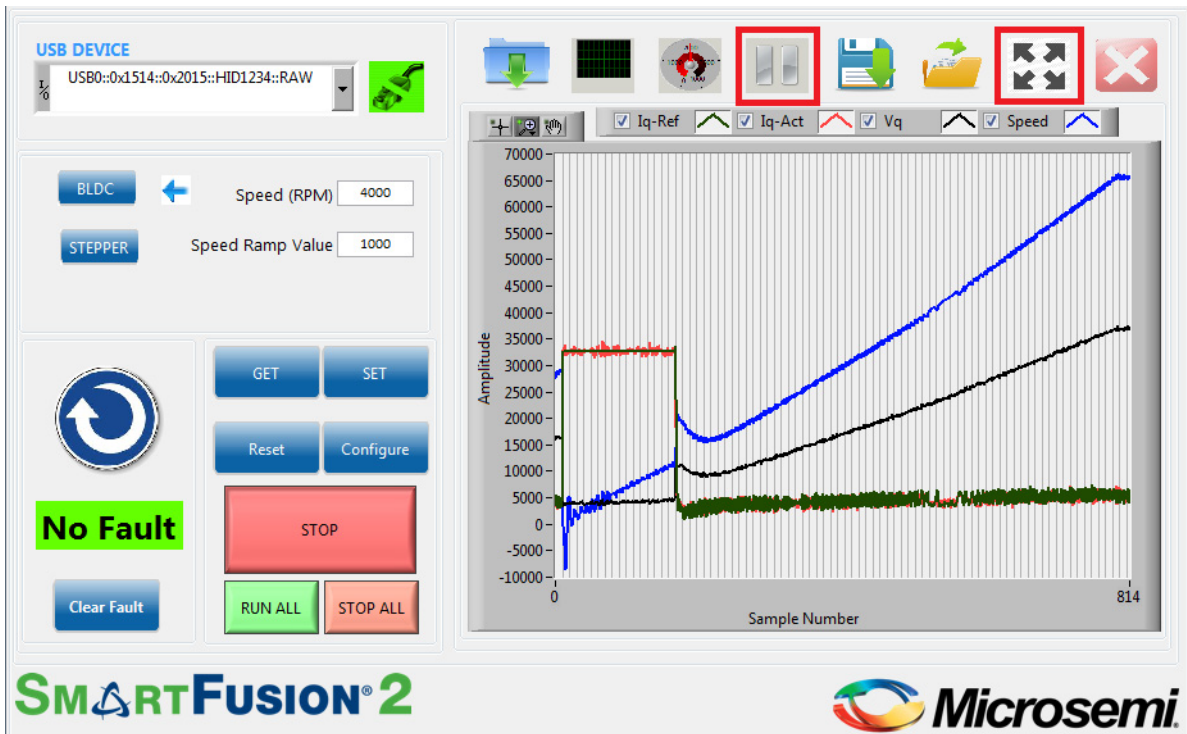

- Click **Expand Plot Window** to display the debug waveforms in a separate window as shown in the following figure. Use the graph palette highlighted in the following figure to expand and analyze the waveforms.

**Figure 20 • Plot Waveforms Window**

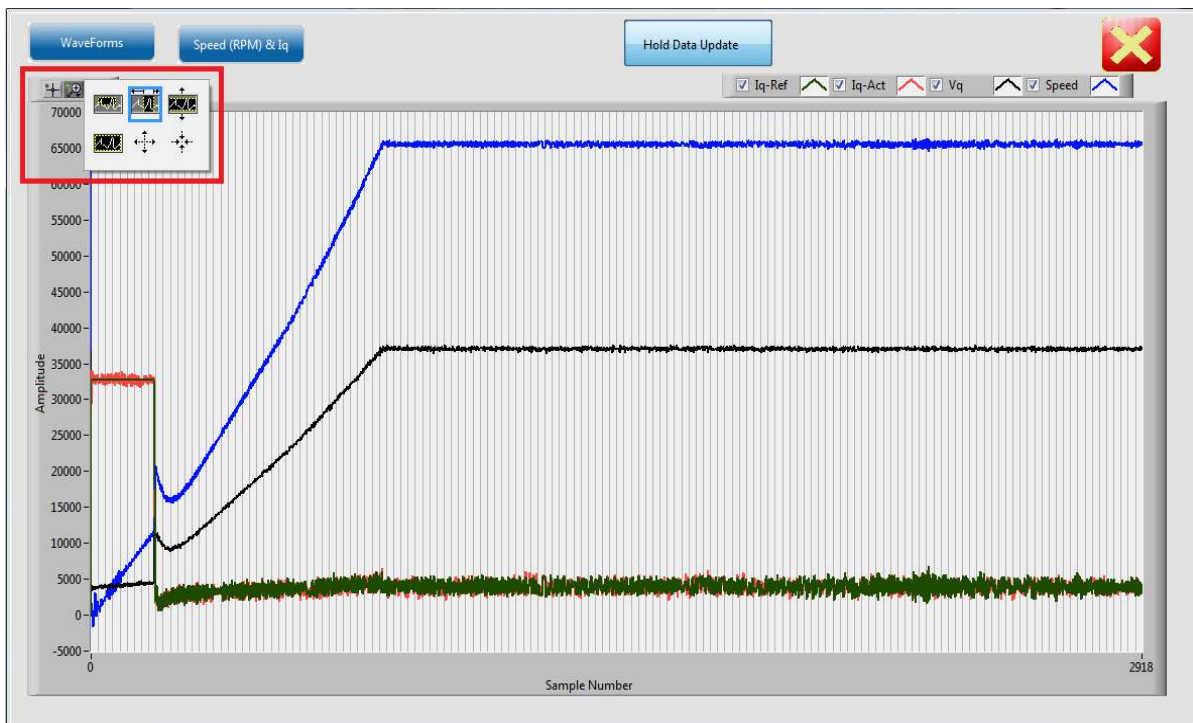

**Note:** The following figure shows the plots corresponding to the motor axis. All plots are in per unit where a value of 65536 represents the rated value.

**Figure 21 • Plot Waveforms Window with Options**

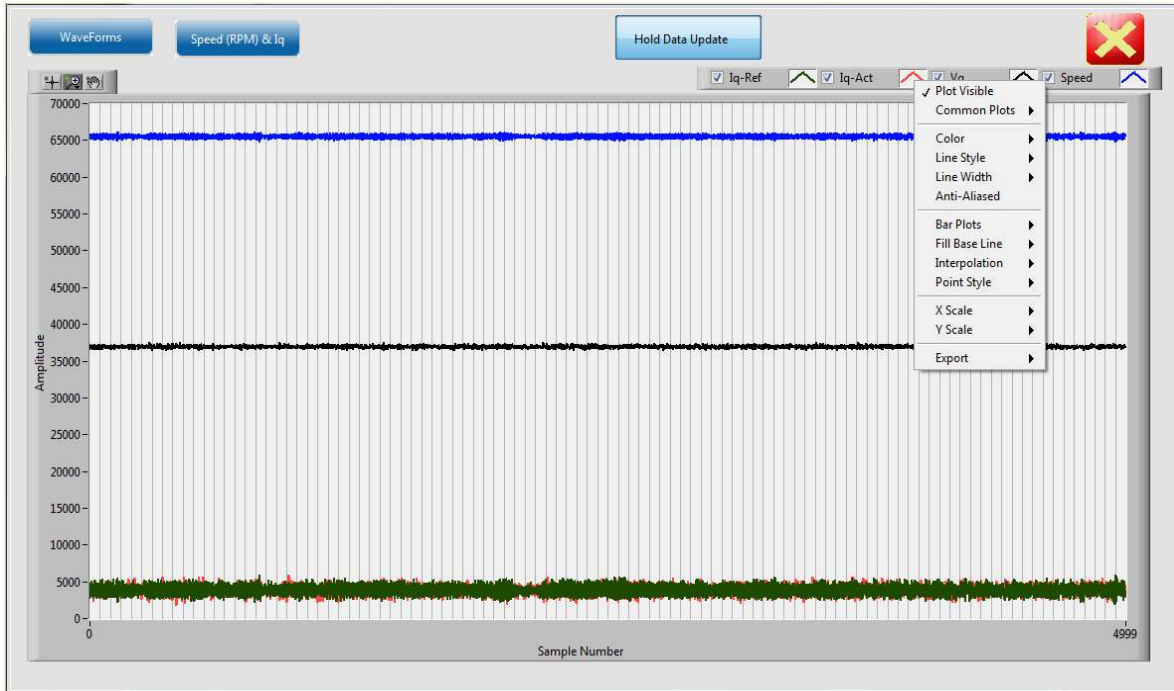

7. Right-click on the plot menu to invoke the following options:
  - a. Click  $\wedge$  next to each plot to use the available options.
  - b. Use the graph palette highlighted in [Figure 20](#), page 17 to move cursors, zoom, or to pan the display. The graph palette appears with the following options, in order from left to right:
    - **Pointer Tool:** Changes cursor mode to basic pointer
    - **Zoom:** Zooms in and out of the display.
    - **Panning Tool:** Picks up the plot and moves it around the display.
8. Click **Close Zoom view** to close the waveforms window.



- To view the motor speed on a tachometer dial, click **RPM and Current** as highlighted in the following figure.

**Figure 22 • SmartFusion2 Motor Control GUI - Displaying Speed and Current**

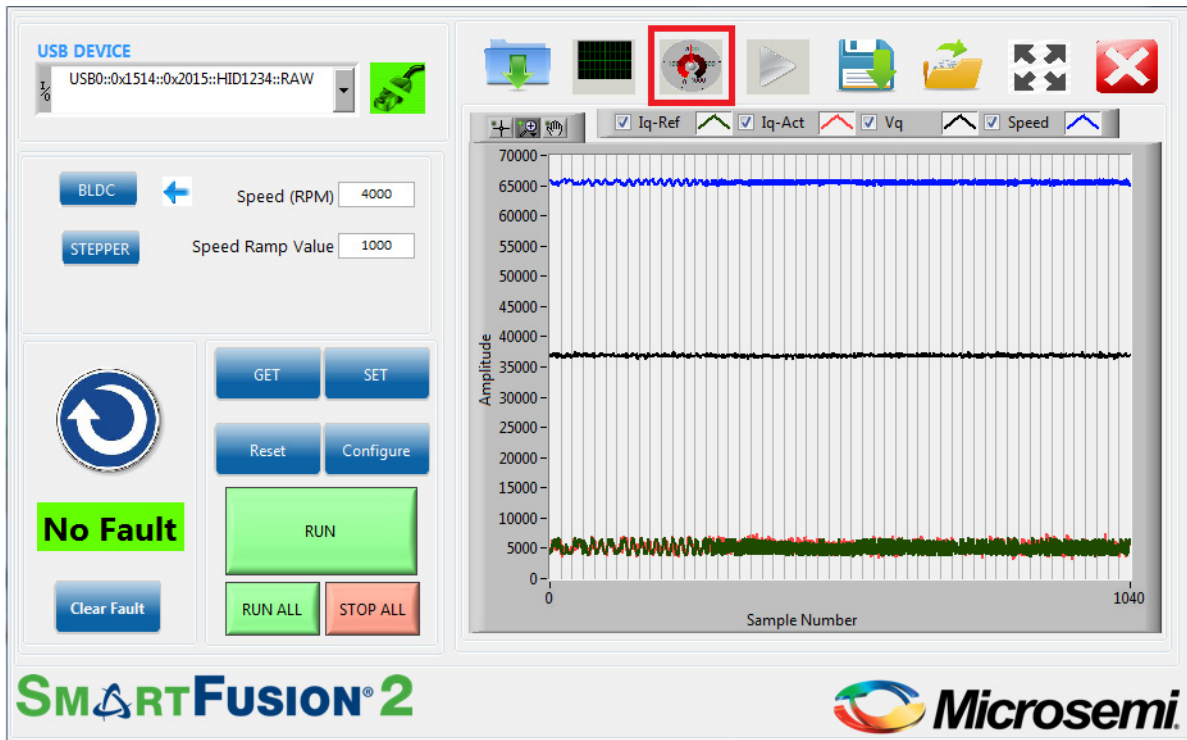



10. Click **Save Waveform** to save the current waveform in the GUI as a .tdms file. The saved waveform can be reloaded by using the **Load Waveform** option and loading the .tdms file.

**Figure 23 • SmartFusion2 Motor Control GUI - Saving and Loading Waveforms**

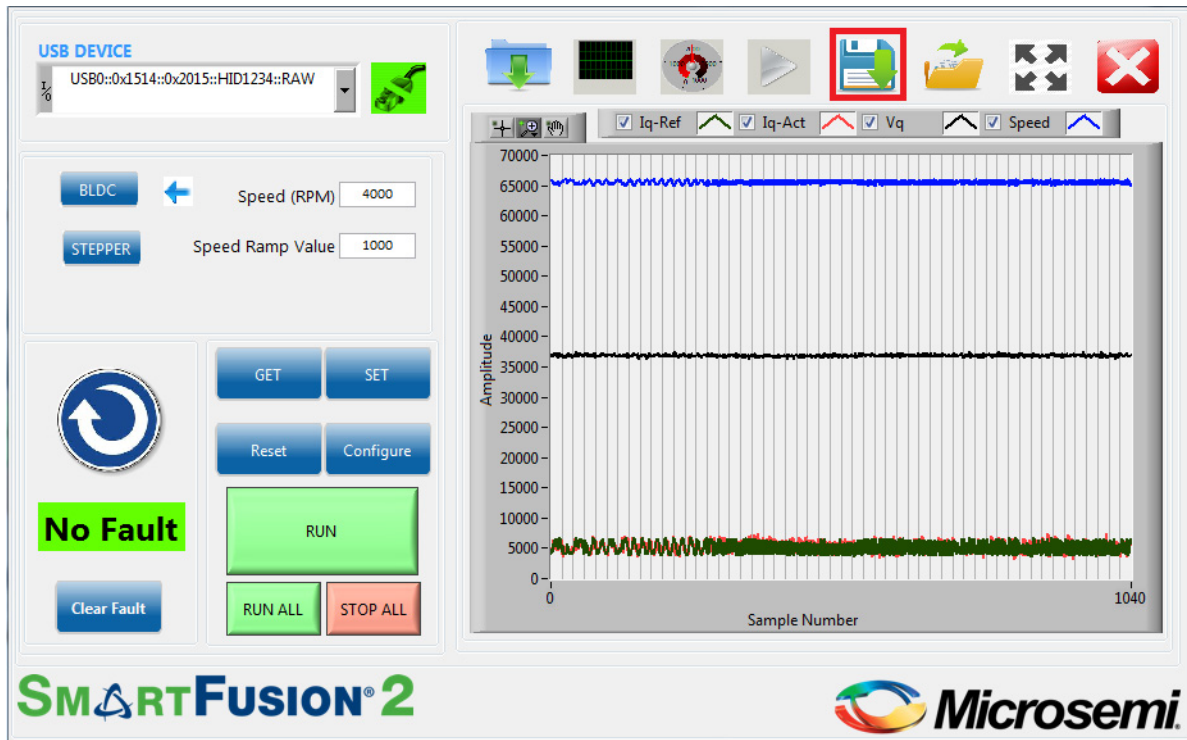

## 2.8 Running Stepper Motors

This design runs stepper motors in Continuous Mode and Position Mode:

**Note:** The Continuous Mode is selected by default.

## 2.8.1 Continuous Mode

In Continuous mode, the motor rotates continuously in the speed that is set by the user. Click **Stop** to stop the running motor.

1. Click **Stepper** to select the stepper motor.
2. Verify that the **Speed mode** option is selected.
3. Click **GET** to see the current parameters. Click **Configure** to open a list of configurable parameters.

Figure 24 • SmartFusion2 Motor Control GUI - Stepper Motor Window

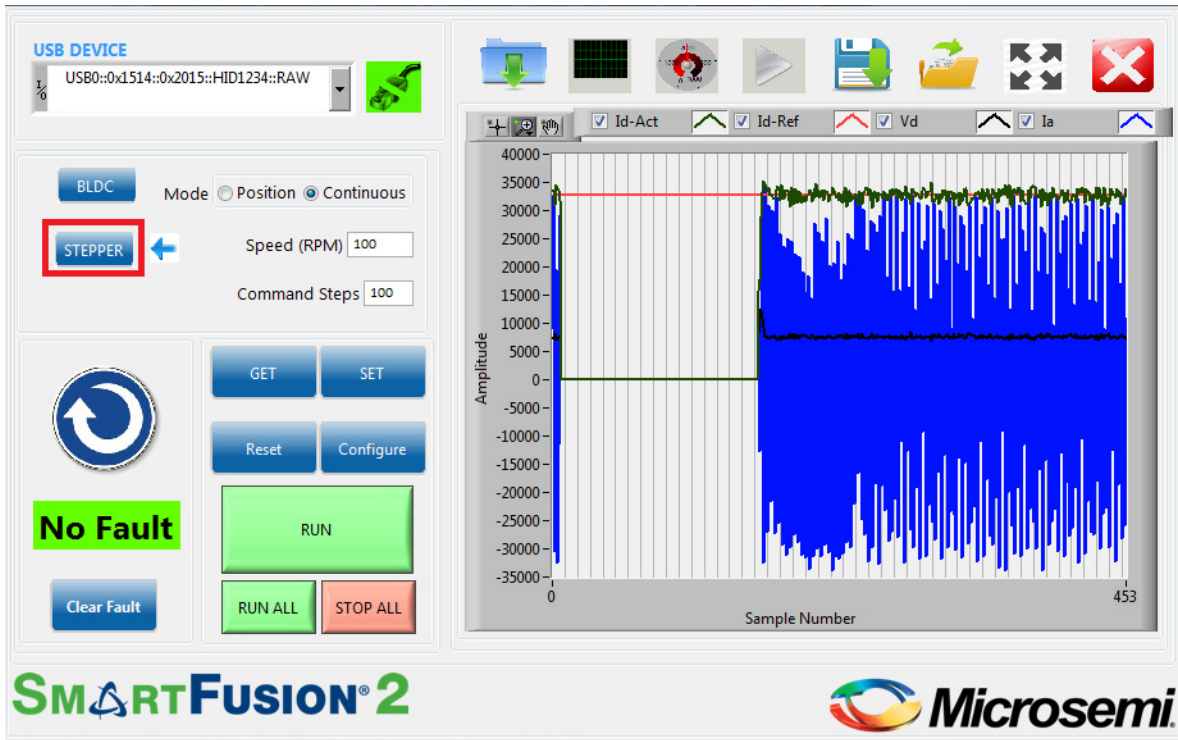

4. Click **Reset** to reset all the stepper parameters to their default values, and click **SET** to enter these values into the system.
5. Click **RUN** to run the motor with the current parameters.
6. Select step resolution value from the **Step Resolution** drop-down list.
7. Enter a speed value between 1 and 200 RPM in **Speed (RPM)** and click **SET**.

**Note:** It is not necessary to stop the motor to change motor speed or the step resolution.

**Note:** To change the direction of the motor, click **Motor Direction**.

8. To increase motor torque, increase the current reference and click **SET**.

**CAUTION:** Increasing the current scaling value increases the motor current and the motor gets heated if run for a long time.

9. Click **STOP** to stop the motor.

## 2.8.2 Position Mode

In Position mode, the motor rotates and stops as per the command steps. It rotates in the speed that is set by the user.

1. Select **Position mode** option and click **SET**.
2. Enter the required (absolute) position in **Command Steps**.
  - a. The motor provided with the kit has a step number of 200 by default. To run the motor through one revolution, enter 200 in **Command Steps**.
  - b. Click **SET**.
  - c. Click **RUN**. The motor runs through the specified number of steps.

- In the Position mode, the motor moves through a fixed number of steps after which the motor stops rotating, but remains energized.
- To move to a different position, enter the new position and click **SET**.
- Click **STOP** to de-energize the motor. When the motor is de-energized, the current position is lost.

Plotting debug parameters by clicking **Plot Waveforms**, displays  $I_d$  PI output as plot 0, d-axis motor current ( $I_d$ ) as plot 1, the number of steps moved (step count) as plot 2, and the angle generated as plot 3. The following figure shows the GUI in position mode.

**Figure 25 • SmartFusion2 Motor Control GUI - Stepper Motor in Position Mode**

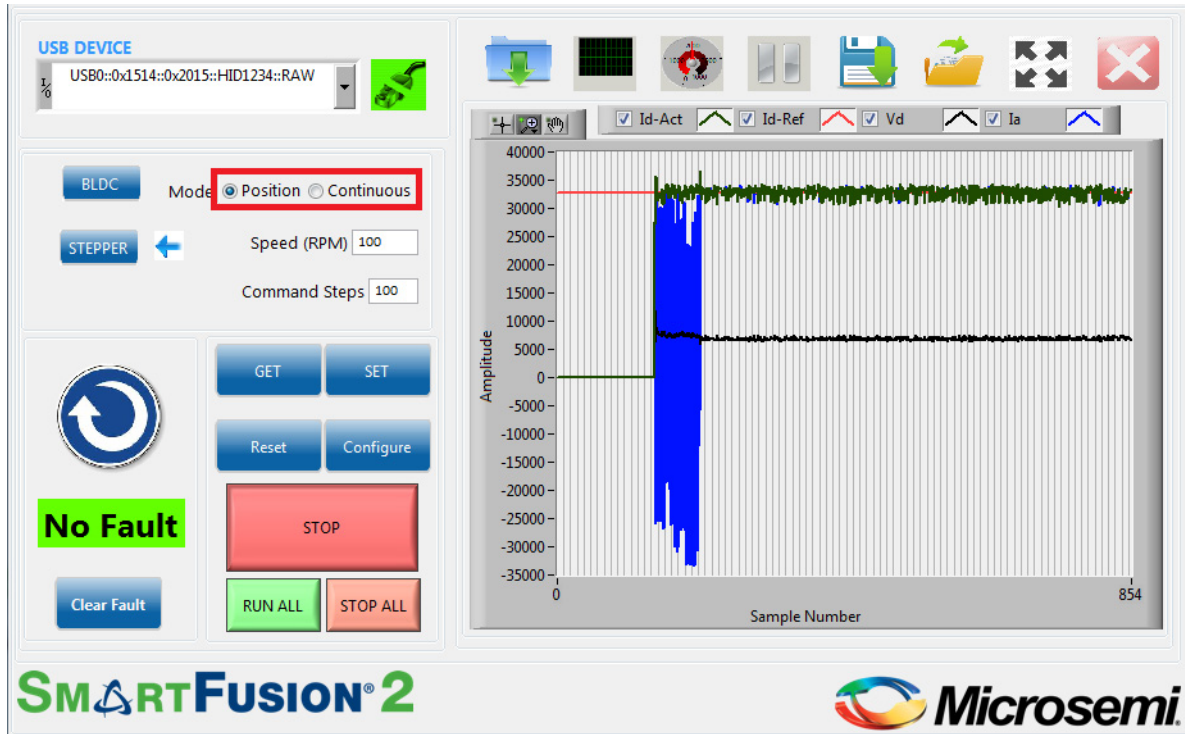

The motor runs at the speed set by the user in **Speed (RPM)** through the number of steps entered in **Command Steps** as shown in the preceding figure.

- Click **Configure** to open the **Configure Stepper Motor Parameters** window, as shown in the following figure.

**Figure 26 • Configure Stepper Motor Parameters Window**

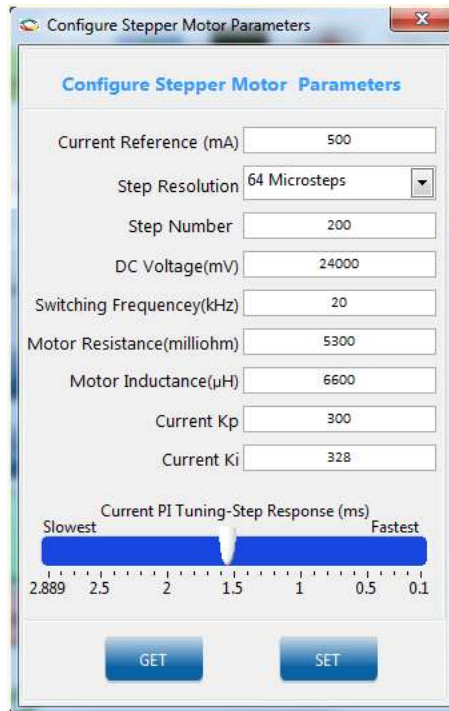

- Click **STOP** to stop the motor/de-energize the motor.
- Click **EXIT** to exit the SmartFusion2 Motor Control GUI.

## 2.9 Register Dump Feature

The register dump feature generates a csv file with data to be programmed in each FPGA register, which is calculated based on motor configuration inputs.

1. Click the icon marked in the following figure to open the **Register Dump window**.

**Figure 27 • Register Dump window**

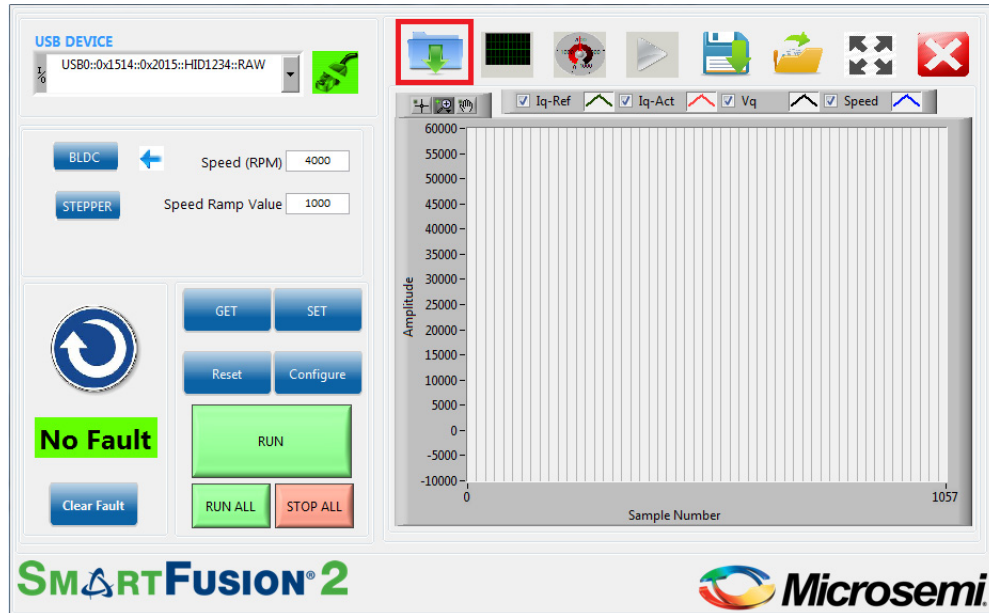

- The following figure shows the **BLDC tab** of the register dump window. The **Save to File** button opens a dialog box to specify the location and the name of the csv file. The generated csv file contains only the data corresponding to the BLDC blocks.

**Figure 28 • Register Dump window—BLDC Tab**

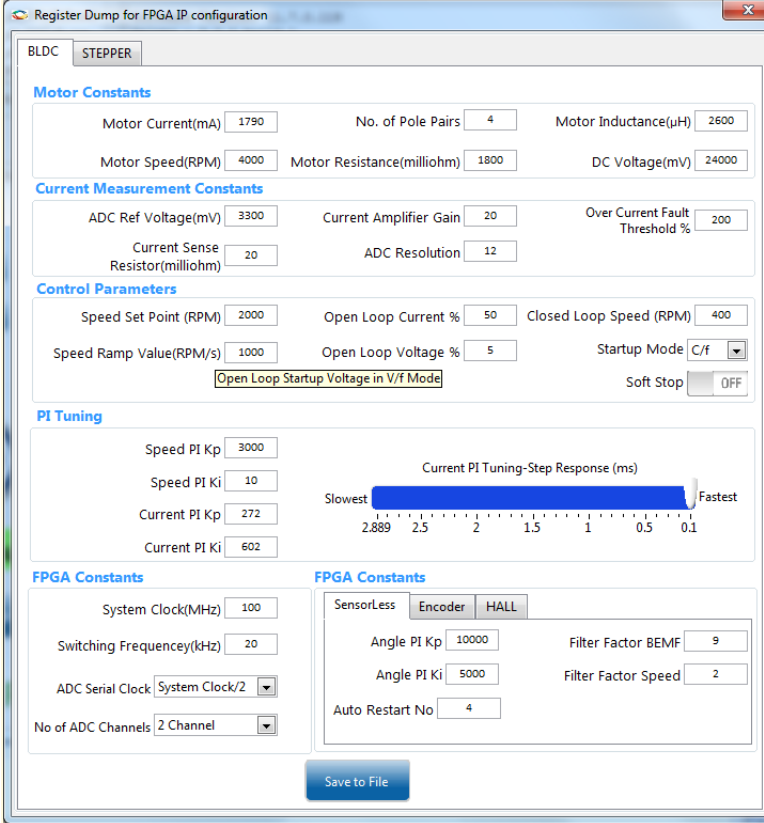

Register Dump for FPGA IP configuration

BLDC STEPPER

**Motor Constants**

Motor Current(mA) 1790 No. of Pole Pairs 4 Motor Inductance( $\mu$ H) 2600  
 Motor Speed(RPM) 4000 Motor Resistance(milliohm) 1800 DC Voltage(mV) 24000

**Current Measurement Constants**

ADC Ref Voltage(mV) 3300 Current Amplifier Gain 20 Over Current Fault Threshold % 200  
 Current Sense Resistor(milliohm) 20 ADC Resolution 12

**Control Parameters**

Speed Set Point (RPM) 2000 Open Loop Current % 50 Closed Loop Speed (RPM) 400  
 Speed Ramp Value(RPM/s) 1000 Open Loop Voltage % 5 Startup Mode C/f  
 Open Loop Startup Voltage in V/f Mode  Soft Stop OFF

**PI Tuning**

Speed PI Kp 3000  
 Speed PI Ki 10  
 Current PI Kp 272  
 Current PI Ki 602

Current PI Tuning-Step Response (ms)  
 Slowest 2.889 2.5 2 1.5 1 0.5 0.1 Fastest

**FPGA Constants**

System Clock(MHz) 100  
 Switching Frequency(kHz) 20  
 ADC Serial Clock System Clock/2  
 No of ADC Channels 2 Channel

**FPGA Constants**

SensorLess Encoder HALL  
 Angle PI Kp 10000 Filter Factor BEMF 9  
 Angle PI Ki 5000 Filter Factor Speed 2  
 Auto Restart No 4

Save to File

- The following figure shows the **Stepper** tab of the register dump window. The **Save to File** button opens a dialog box to specify the location and the name of the csv file. The generated csv file contains only the data corresponding to the stepper blocks.

**Figure 29 • Register Dump window—Stepper Tab**

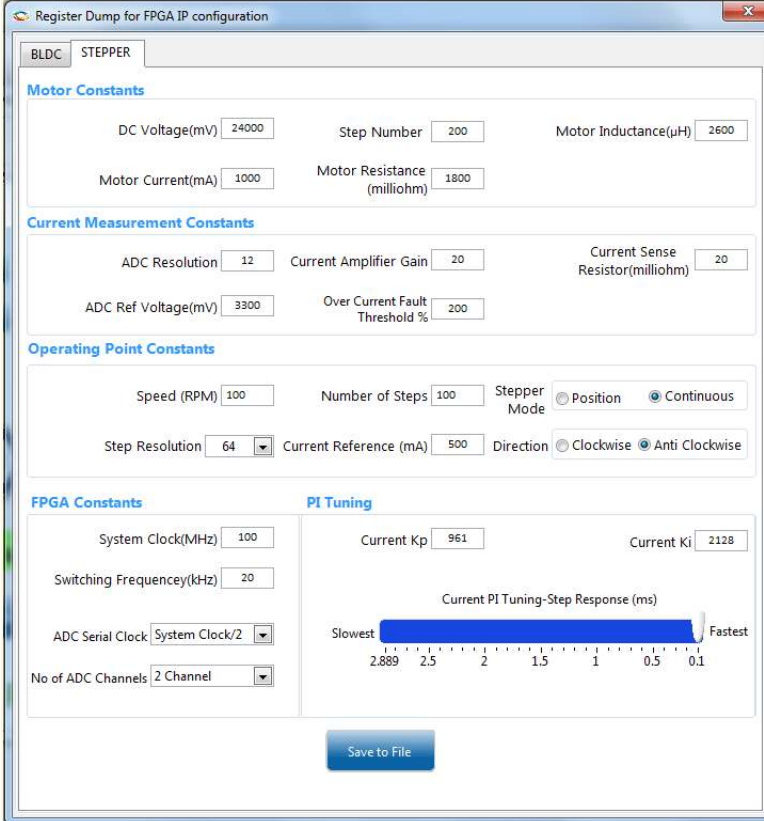

The screenshot shows the "Register Dump for FPGA IP configuration" window with the "STEPPER" tab selected. The window is divided into several sections for configuring stepper motor parameters:

- Motor Constants:** DC Voltage (mV) 24000, Step Number 200, Motor Inductance (μH) 2600, Motor Current (mA) 1000, Motor Resistance (milliohm) 1800.
- Current Measurement Constants:** ADC Resolution 12, Current Amplifier Gain 20, Current Sense Resistor (milliohm) 20, ADC Ref Voltage (mV) 3300, Over Current Fault Threshold % 200.
- Operating Point Constants:** Speed (RPM) 100, Number of Steps 100, Stepper Mode (Position, Continuous), Step Resolution 64, Current Reference (mA) 500, Direction (Clockwise, Anti Clockwise).
- FPGA Constants:** System Clock (MHz) 100, Switching Frequency (kHz) 20, ADC Serial Clock (System Clock/2), No of ADC Channels (2 Channel).
- PI Tuning:** Current Kp 961, Current Ki 2128, Current PI Tuning-Step Response (ms) slider (Slowest to Fastest).

A "Save to File" button is located at the bottom center of the window.



4. The following figure shows a sample csv file, which contains data calculated based on the inputs provided in the register dump window.

**Figure 30 • Sample Csv File**

	A	B	C	D	E	F	G	H	I	J	K	L	M	N	O
1	Parameter	Address(0x)	Data(0x)	Remarks											
2	adc_control_reg_val_o	0	1	Configures ADC Interface block based on number of channels and SPI clock frequency											
3	adc_scale_val_o	20	49BE	Current scaling constant											
4	adc_oc_thresh_o	24	FFFE	Overcurrent threshold											
5	pwm_period_val_o	34	9C4	PWM period											
6	pwm_gain_val_o	40	B46	PWM gain input to PWM3ph block											
7	speed_pi_kp_o	50	BB8	Speed PI - Proportional Constant											
8	speed_pi_ki_o	54	A	Speed PI - Integral Constant											
9	iq_pi_kp_o	60	110	Current PI - Proportional Constant											
10	iq_pi_ki_o	64	25A	Current PI - Integral Constant											
11	rate_limit_ref_in_o	70	8000	Motor Speed Command/Set point											
12	rate_limit_slew_cnt_o	74	C8	Rate limiter block input											
13	rate_limit_rate_cnt_o	78	4000	Rate limiter block input											
14	direction_config_o	90	0	Direction configuration											
15	start_motor_o	94	1	When 1 starts motor											
16	olmng_theta_factor_o	98	18F	Theta factor computation											
17	seq_cntl_config_o	9C	4	Enable/Disable of (i) Current PI Controllers (ii) Sensor Calibration (iii) Soft Stop Control (iv) Auto-Restart on rotor lock											
18	olmng_dv_o	A0	CCD	Open loop voltage reference											
19	olmng_iq_ref_in_o	A4	8000	Open loop current reference											
20	seq_cntl_cl_omega_o	A8	199A	Close loop switchover speed											
21	stop_motor_o	AC	0	When 1 over-rides start_motor_o signal and stops motor.											
22	auto_restart_no_o	B4	4	Number of auto restarts on detecting rotor lock before asserting fault											
23	fault_clr_o	B8	0	When 1 clears fault											
24	Ls_by_Ts_pu_o	200	D71	Angle Estimator Input											
25	Rs_pu_o	204	77	Angle Estimator Input											
26	angle_kp_o	208	2710	Angle PI - Proportional Constant											
27	angle_ki_o	20C	1388	Angle PI - Integral Constant											
28	speed_factor_o	300	4444	Encoder Speed factor											
29	angle_factor_o	304	FFFF	Encoder Angle factor											
30	angle_count_max_o	308	59F	Encoder Angle Count max input											
31	en_filter_factor_omega	30C	5	Encoder filter factor											
32	hall_sensor_polarity_o	408	0	Hall sensor polarity input											
33	hall_filter_factor_o	40C	8	Hall interface filter factor input											
34	hall_speed_factor_o	410	F00	Hall interface speed factor input											
35	filter_factor_bemf_o	210	9	Hall interface BEMF filter factor											
36	filter_factor_omega_o	214	2	Hall interface Speed filter factor											
37															



### 3 Appendix: Jumper Settings

The following table lists the jumpers that are required to be set on the SmartFusion2 Starter Kit board.

**Table 2 • Jumper Settings on the SmartFusion2 Starter Kit Board**

Jumper	Function	Default Settings	Notes
<b>Power Supply</b>			
J23	SOM power source	1-3 Closed	On-board power to SOM
J22	JTAG Mode	3-4 Closed	JTAG VPP to 3.3 V
J7, J13	Encoder – Single Ended selection	Open	To be set for single ended encoder
J8	Encoder – Differential selection	Open	To be set for differential encoder
J19	Shunt resistor for power measurement	Open	Voltage can be measured across shunt
J11	Encoder	Open	Port to connect encoder

The following figure shows the Jumpers on SmartFusion2 Starter Kit.

**Figure 31 • Jumpers on SmartFusion2 Starter Kit**

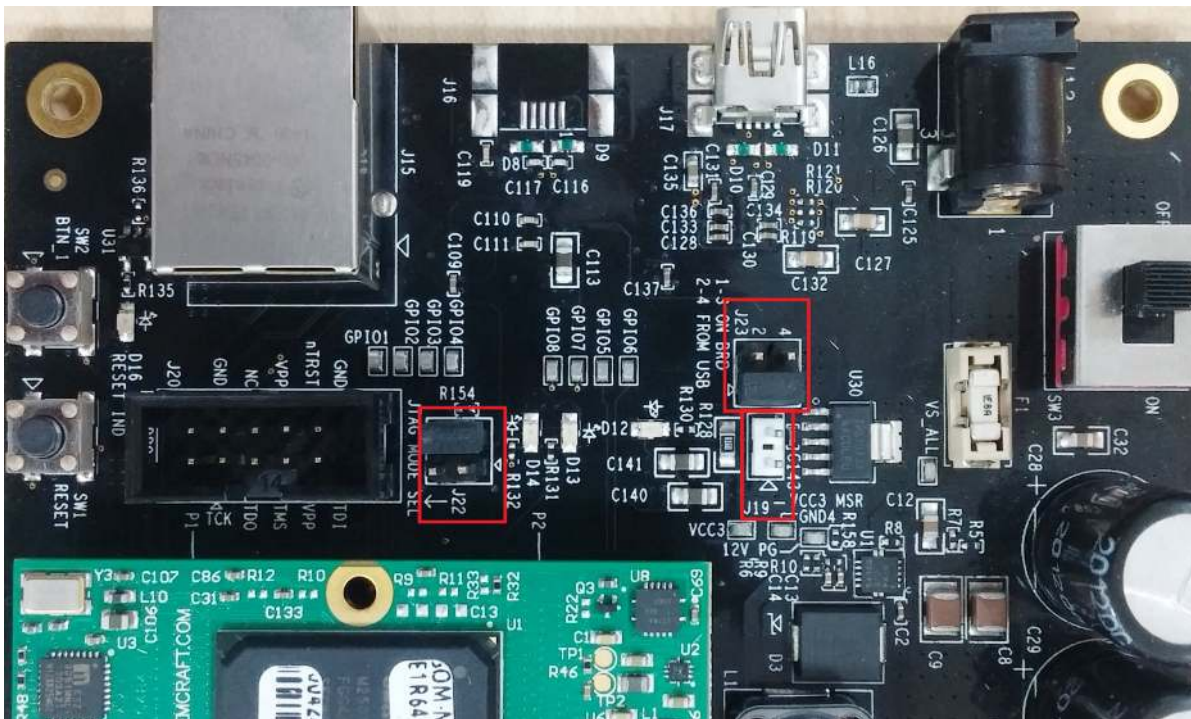

## 4 Appendix: Connecting the Motor Terminals

### 4.1 BLDC Motor Connections

The following steps describe how to connect to the BLDC motor:

1. Identify and isolate the **BLDC Motor Terminals** (set of 3) and **Hall Sensor Terminals** (set of 5), as shown in the following figure. These terminals are tied together.
2. Connect the **BLDC Motor Terminals** to the three pin plug.
3. Connect the **Hall Sensor Terminals** to the five pin plug.

**Figure 32 • Wiring Diagram for BLDC Motor Connectors**

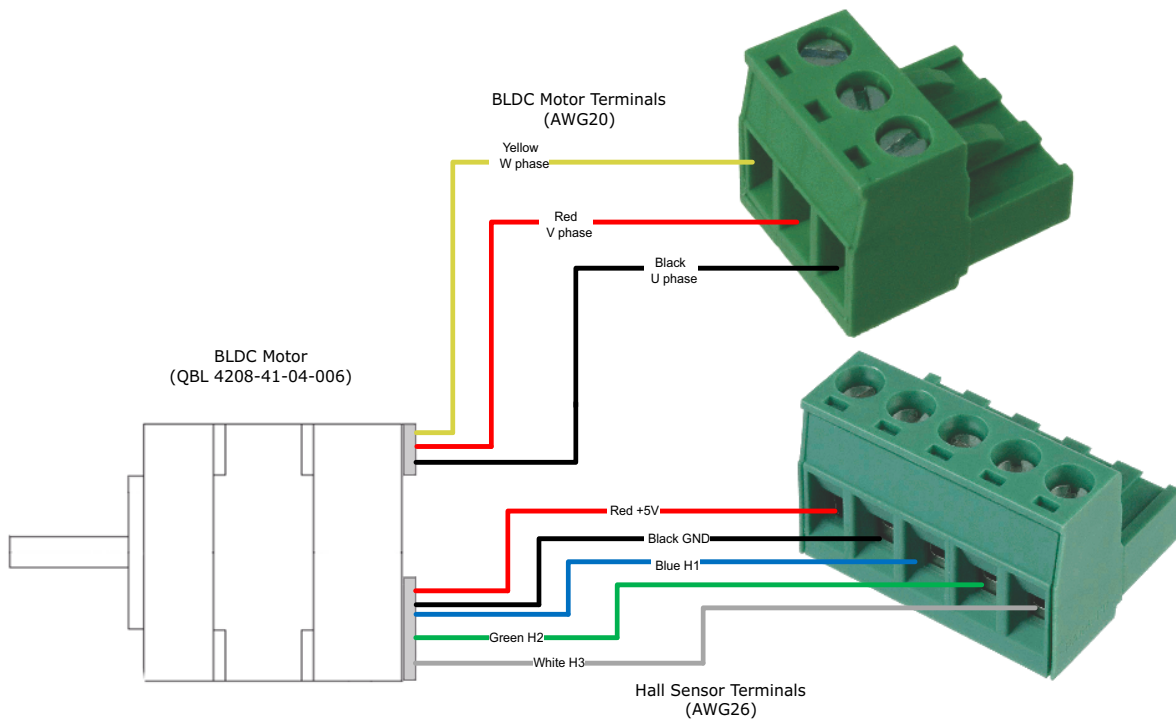

### 4.1.1 Stepper Motor Connections

The stepper motor has four terminals. The motor terminals of the stepper motor must be connected to the four pin plug, as shown in the following figure.

**Figure 33 • Wiring Diagram for Stepper Motor Connectors**

