

MOSFET

650 V CoolSiC™ M1 SiC Trench Power Device

The 650 V CoolSiC™ is built over the solid silicon carbide technology developed in Infineon in more than 20 years. Leveraging the wide bandgap SiC material characteristics, the 650V CoolSiC™ MOSFET offers a unique combination of performance, reliability and ease of use. Suitable for high temperature and harsh operations, it enables the simplified and cost effective deployment of the highest system efficiency.

Features

- Optimized switching behavior at higher currents
- Commutation robust fast body diode with low Q_f
- Superior gate oxide reliability
- $T_{j,max}=175^{\circ}\text{C}$ and excellent thermal behavior
- Lower $R_{DS(on)}$ and pulse current dependency on temperature
- Increased avalanche capability
- Compatible with standard drivers (recommended driving voltage: 0V-18V)
- Kelvin source provides up to 4 times lower switching losses

Benefits

- Unique combination of high performance, high reliability and ease of use
- Ease of use and integration
- Suitable for topologies with continuous hard commutation
- Higher robustness and system reliability
- Efficiency improvement
- Reduced system size leading to higher power density

Potential applications

- Telecom and Server SMPS
- UPS (uninterruptable power supplies)
- Solar PV inverters
- EV charging infrastructure
- Energy storage and battery formation
- Class D amplifiers

Product validation

Fully qualified according to JEDEC for Industrial Applications

Please note: The source and sense source pins are not exchangeable. Their exchange might lead to malfunction.

Table 1 Key Performance Parameters

Parameter	Value	Unit
$V_{DS} @ T_J = 25^{\circ}\text{C}$	650	V
$R_{DS(on),typ}$	39	m Ω
$R_{DS(on),max}$	51	m Ω
$Q_{G,typ}$	41	nC
I_{DM}	122	A
$Q_{oss} @ 400\text{ V}$	97	nC
$E_{oss} @ 400\text{ V}$	14.6	μJ

Type / Ordering Code	Package	Marking	Related Links
IMBG65R039M1H	PG-TO263-7-12	65R039M1	see Appendix A

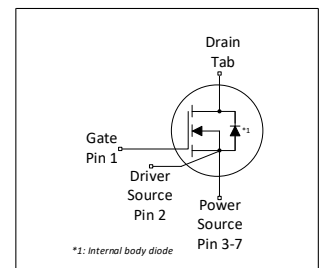
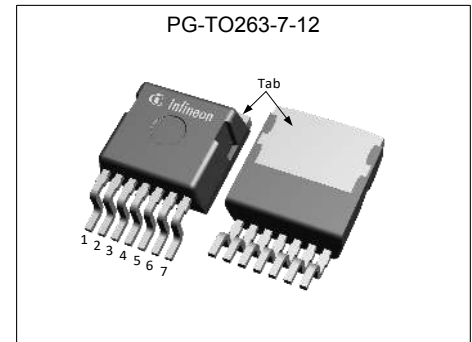

RoHS

Table of Contents

Description	1
Maximum ratings	3
Thermal characteristics	4
Operating range	4
Electrical characteristics	5
Electrical characteristics diagrams	7
Test Circuits	12
Package Outlines	13
Appendix A	14
Revision History	15
Trademarks	15
Disclaimer	15

1 Maximum ratings

at $T_J = 25\text{ °C}$, unless otherwise specified

Table 2 Maximum ratings

Parameter	Symbol	Values			Unit	Note / Test Condition
		Min.	Typ.	Max.		
Continuous DC drain current ¹⁾	I_D	-	-	54 38	A	$T_C = 25\text{ °C}$ $T_C = 100\text{ °C}$
Peak drain current ²⁾	I_{DM}	-	-	122	A	$T_C = 25\text{ °C}$
Avalanche energy, single pulse	E_{AS}	-	-	213	mJ	$I_D = 8.0\text{ A}$, $V_{DD} = 50\text{ V}$; see table 11
Avalanche energy, repetitive	E_{AR}	-	-	1.06	mJ	$I_D = 8.0\text{ A}$, $V_{DD} = 50\text{ V}$; see table 11
Avalanche current, single pulse	I_{AS}	-	-	8.0	A	-
MOSFET dv/dt ruggedness	dv/dt	-	-	200	V/ns	$V_{DS} = 0\text{...}400\text{ V}$
Gate source voltage (static) ³⁾	V_{GS}	-5	-	23	V	static
Gate source voltage (transient)	V_{GS}	-7	-	25	V	$t_{pulse, positive} \leq 1\%$ duty cycle/ f_{sw}
Power dissipation	P_{tot}	-	-	211	W	$T_C = 25\text{ °C}$
Storage temperature	T_{stg}	-55	-	150	°C	-
Operating junction temperature	T_J	-55	-	175	°C	-
Mounting torque	-	-	-	n.a.	Ncm	-
Continuous reverse drain current ¹⁾	I_{SDC}	-	-	54 35	A	$V_{GS}=18\text{ V}$, $T_C = 25\text{ °C}$ $V_{GS}=0\text{ V}$, $T_C = 25\text{ °C}$
Repetitive peak reverse drain current ¹⁾	I_{SRM}	-	-	122	A	$T_C = 25\text{ °C}$, pulse width $t_p \leq 250\text{ ns}$
Insulation withstand voltage	V_{ISO}	-	-	n.a.	V	V_{rms} , $T_C = 25\text{ °C}$, $t = 1\text{ min}$

¹⁾ Limited by $T_{J,max}$

²⁾ Pulse width t_p limited by $T_{J,max}$

³⁾ The maximum gate-source voltage in the application design should be in accordance to IPC-9592B

2 Thermal characteristics

Table 3 Thermal characteristics

Parameter	Symbol	Values			Unit	Note / Test Condition
		Min.	Typ.	Max.		
Thermal resistance, junction - case	R_{thJC}	-	-	0.71	°C/W	-
Thermal resistance, junction - ambient	R_{thJA}	-	-	62	°C/W	device on PCB, minimal footprint
Thermal resistance, junction - ambient for SMD version	R_{thJA}	-	35	45	°C/W	Device on 40mm*40mm*1.5mm epoxy PCB FR4 with 6cm ² (one layer, 70µm thickness) copper area for drain connection and cooling. PCB is vertical without air stream cooling.
Soldering temperature, wave- & reflow soldering allowed	T_{sold}	-	-	260	°C	reflow MSL1

3 Operating range

Table 4 Operating range

Parameter	Symbol	Values			Unit	Note / Test Condition
		Min.	Typ.	Max.		
Gate-source voltage operating range including undershoots ¹⁾	V_{GS}	-2	-	20	V	-

¹⁾ **Important note: the selection of positive and negative gate-source voltages impacts the long-term behavior of the device.** The design guidelines described in the CoolSiC™ MOSFET 650 V M1 trench power device application note AN_1907_PL52_1911_144109 must be considered to ensure sound operation of the device over the planned lifetime.

4 Electrical characteristics

at $T_J = 25\text{ °C}$, unless otherwise specified

Table 5 Static characteristics

Parameter	Symbol	Values			Unit	Note / Test Condition
		Min.	Typ.	Max.		
Drain-source breakdown voltage	$V_{(BR)DSS}$	650	-	-	V	$V_{GS} = 0\text{ V}$, $I_D = 0.75\text{ mA}$
Gate threshold voltage ¹⁾	$V_{GS(th)}$	3.5	4.5	5.7	V	$V_{DS} = V_{GS}$, $I_D = 7.5\text{ mA}$
Zero gate voltage drain current	I_{DSS}	-	1 3	150 -	μA	$V_{DS} = 650\text{ V}$, $V_{GS} = 0\text{ V}$, $T_J = 25\text{ °C}$ $V_{DS} = 650\text{ V}$, $V_{GS} = 0\text{ V}$, $T_J = 175\text{ °C}$
Gate leakage current	I_{GSS}	-	-	100	nA	$V_{GS} = 20\text{ V}$, $V_{DS} = 0\text{ V}$
Drain-source on-state resistance	$R_{DS(on)}$	-	0.039 0.055	0.051 -	Ω	$V_{GS} = 18\text{ V}$, $I_D = 25.0\text{ A}$, $T_J = 25\text{ °C}$ $V_{GS} = 18\text{ V}$, $I_D = 25.0\text{ A}$, $T_J = 175\text{ °C}$
Internal gate resistance	R_G	-	5.0	-	Ω	$f = 1\text{ MHz}$

Table 6 Dynamic characteristics

Parameter	Symbol	Values			Unit	Note / Test Condition
		Min.	Typ.	Max.		
Input capacitance	C_{iss}	-	1393	-	pF	$V_{GS} = 0\text{ V}$, $V_{DS} = 400\text{ V}$, $f = 250\text{ kHz}$
Reverse transfer capacitance	C_{riss}	-	15	-	pF	$V_{GS} = 0\text{ V}$, $V_{DS} = 400\text{ V}$, $f = 250\text{ kHz}$
Output capacitance ²⁾	C_{oss}	-	160	208	pF	$V_{GS} = 0\text{ V}$, $V_{DS} = 400\text{ V}$, $f = 250\text{ kHz}$
Output charge ²⁾	Q_{oss}	-	97	126	nC	calculation based on C_{oss}
Effective output capacitance, energy related ³⁾	$C_{o(er)}$	-	182	-	pF	$V_{GS} = 0\text{ V}$, $V_{DS} = 0...400\text{ V}$
Effective output capacitance, time related ⁴⁾	$C_{o(tr)}$	-	241	-	pF	$I_D = \text{constant}$, $V_{GS} = 0\text{ V}$, $V_{DS} = 0...400\text{ V}$
Turn-on delay time	$t_{d(on)}$	-	7.1	-	ns	$V_{DD} = 400\text{ V}$, $V_{GS} = 18\text{ V}$, $I_D = 25.0\text{ A}$, $R_G = 1.8\text{ }\Omega$; see table 10
Rise time	t_r	-	10.9	-	ns	$V_{DD} = 400\text{ V}$, $V_{GS} = 18\text{ V}$, $I_D = 25.0\text{ A}$, $R_G = 1.8\text{ }\Omega$; see table 10
Turn-off delay time	$t_{d(off)}$	-	17.4	-	ns	$V_{DD} = 400\text{ V}$, $V_{GS} = 18\text{ V}$, $I_D = 25.0\text{ A}$, $R_G = 1.8\text{ }\Omega$; see table 10
Fall time	t_f	-	7	-	ns	$V_{DD} = 400\text{ V}$, $V_{GS} = 18\text{ V}$, $I_D = 25.0\text{ A}$, $R_G = 1.8\text{ }\Omega$; see table 10

¹⁾ Tested after 1 ms pulse at $V_{GS} = +20\text{ V}$

²⁾ Maximum specification is defined by calculated six sigma upper confidence bound

³⁾ $C_{o(er)}$ is a fixed capacitance that gives the same stored energy as C_{oss} while V_{DS} is rising from 0 to 400 V

⁴⁾ $C_{o(tr)}$ is a fixed capacitance that gives the same charging time as C_{oss} while V_{DS} is rising from 0 to 400 V

Table 7 Gate charge characteristics

Parameter	Symbol	Values			Unit	Note / Test Condition
		Min.	Typ.	Max.		
Gate to source charge	Q_{gs}	-	11	-	nC	$V_{DD} = 400\text{ V}$, $I_D = 25.0\text{ A}$, $V_{GS} = 0\text{ to }18\text{ V}$
Gate to drain charge	Q_{gd}	-	9	-	nC	$V_{DD} = 400\text{ V}$, $I_D = 25.0\text{ A}$, $V_{GS} = 0\text{ to }18\text{ V}$
Gate charge total	Q_g	-	41	-	nC	$V_{DD} = 400\text{ V}$, $I_D = 25.0\text{ A}$, $V_{GS} = 0\text{ to }18\text{ V}$

Table 8 Body diode characteristics

Parameter	Symbol	Values			Unit	Note / Test Condition
		Min.	Typ.	Max.		
Drain-source reverse voltage	V_{SD}	-	4.0	-	V	$V_{GS} = 0\text{ V}$, $I_S = 25.0\text{ A}$, $T_J = 25\text{ °C}$
MOSFET forward recovery time	t_{fr}	-	21.2	-	ns	$V_{DD} = 400\text{ V}$, $I_{S0} = 25.0\text{ A}$, $di_S/dt = 1000\text{ A}/\mu\text{s}$; see table 9
MOSFET forward recovery charge	Q_f	-	102	-	nC	$V_{DD} = 400\text{ V}$, $I_{S0} = 25.0\text{ A}$, $di_S/dt = 1000\text{ A}/\mu\text{s}$; see table 9
MOSFET peak forward recovery current	I_{frm}	-	8.3	-	A	$V_{DD} = 400\text{ V}$, $I_{S0} = 25.0\text{ A}$, $di_S/dt = 1000\text{ A}/\mu\text{s}$; see table 9

5 Electrical characteristics diagrams

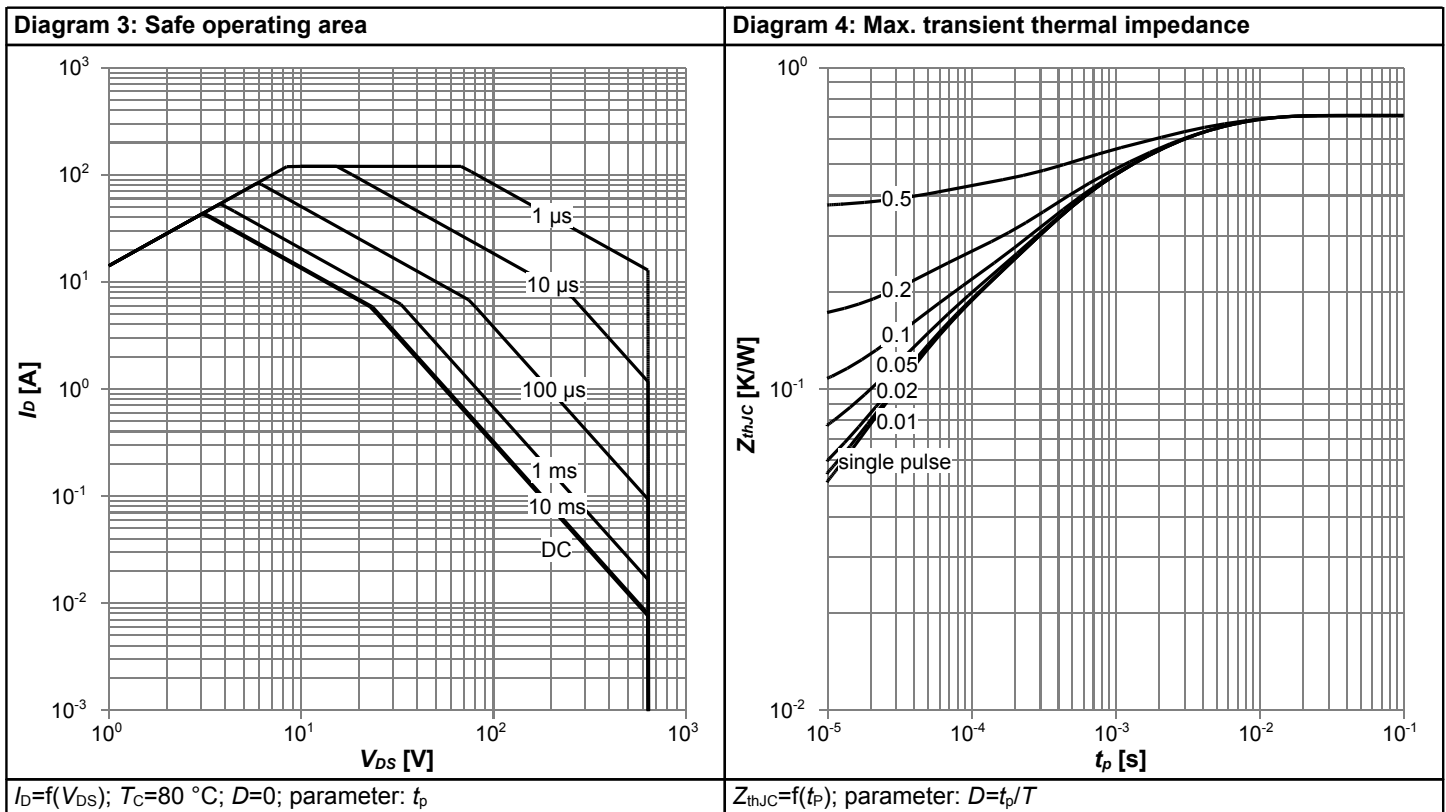
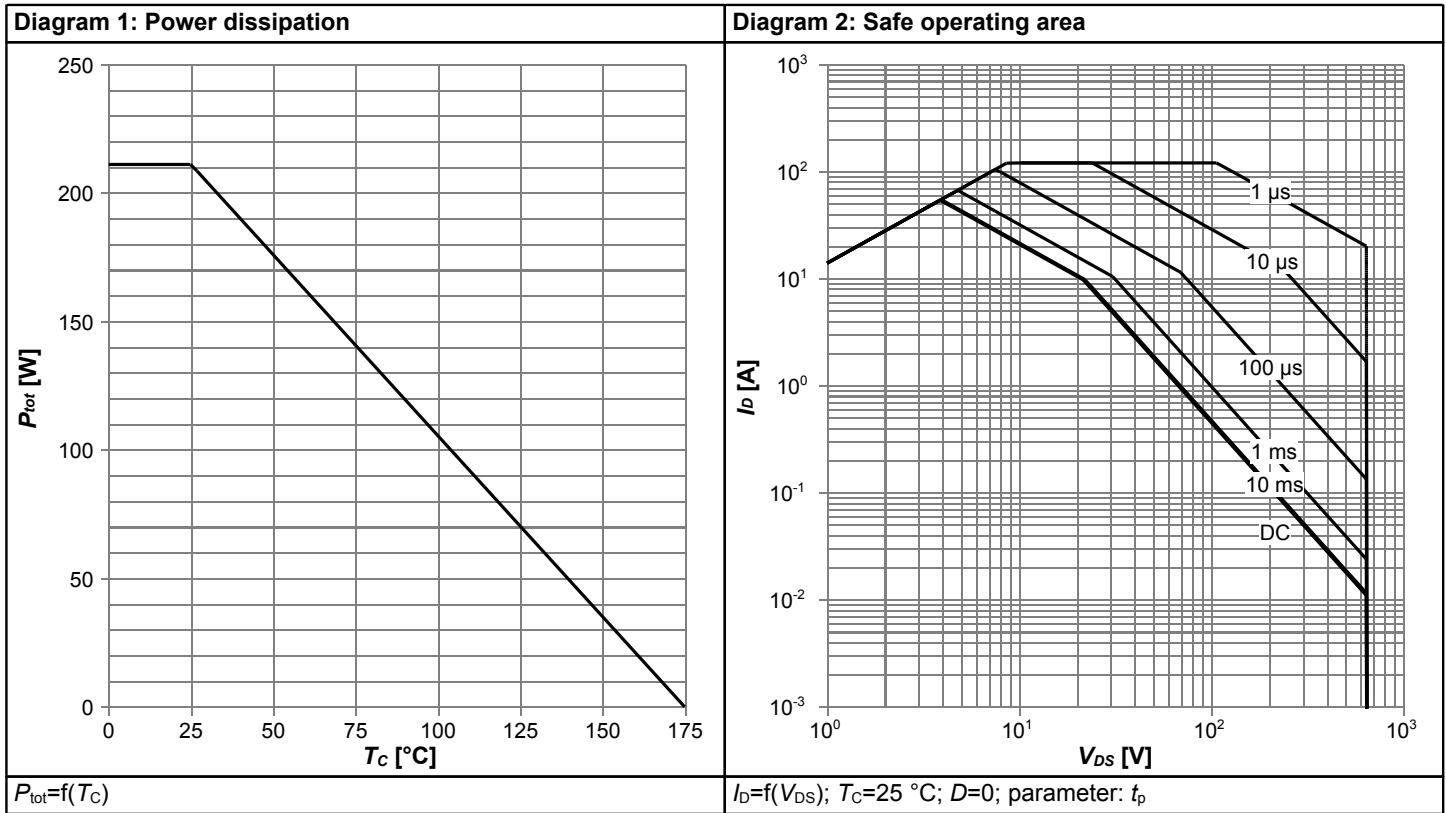
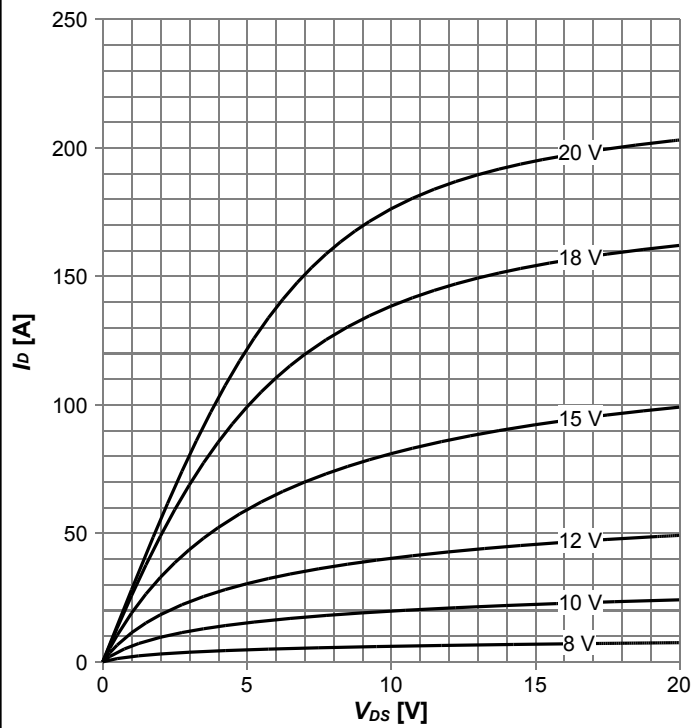
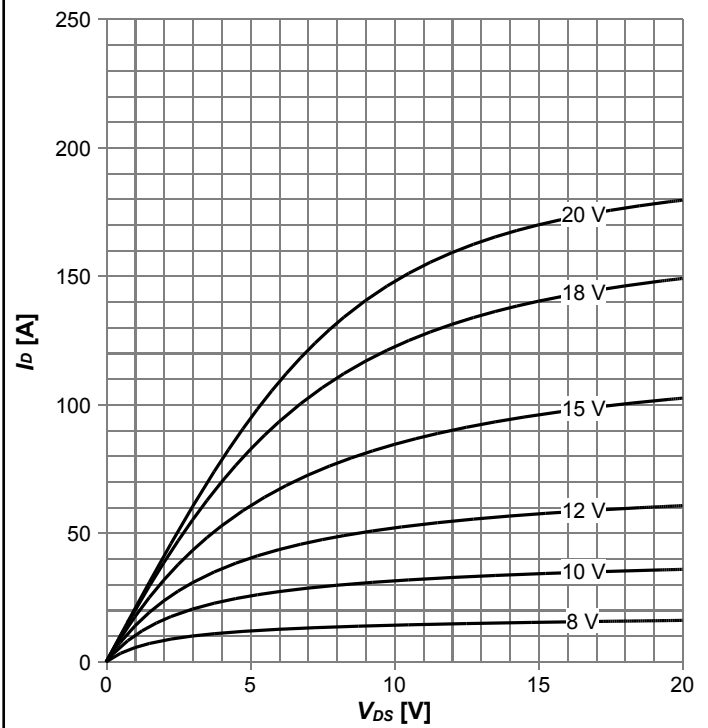

Diagram 5: Typ. output characteristics



$I_D=f(V_{DS})$; $T_j=25\text{ °C}$; parameter: V_{GS}

Diagram 6: Typ. output characteristics



$I_D=f(V_{DS})$; $T_j=150\text{ °C}$; parameter: V_{GS}

Diagram 7: Typ. drain-source on-state resistance

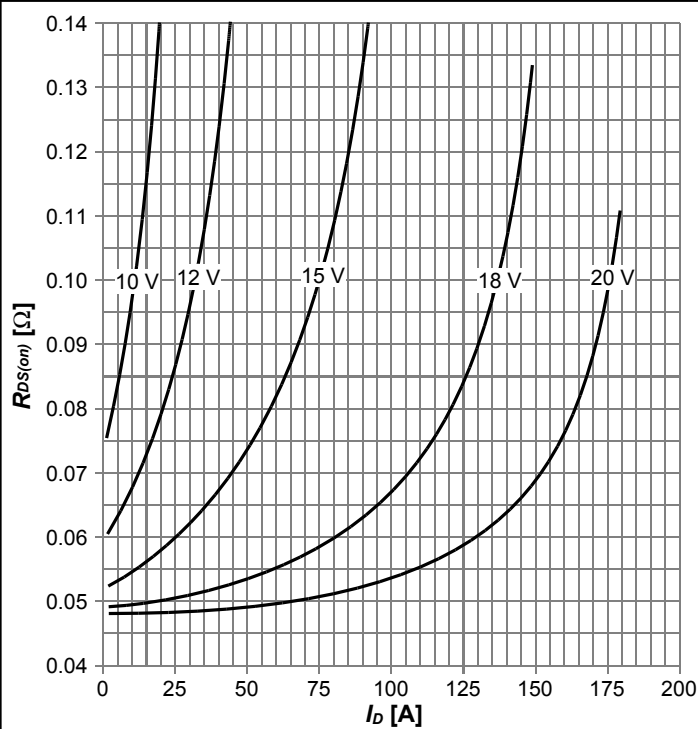

$R_{DS(on)}=f(I_D)$; $T_j=150\text{ °C}$; parameter: V_{GS}

Diagram 8: Drain-source on-state resistance

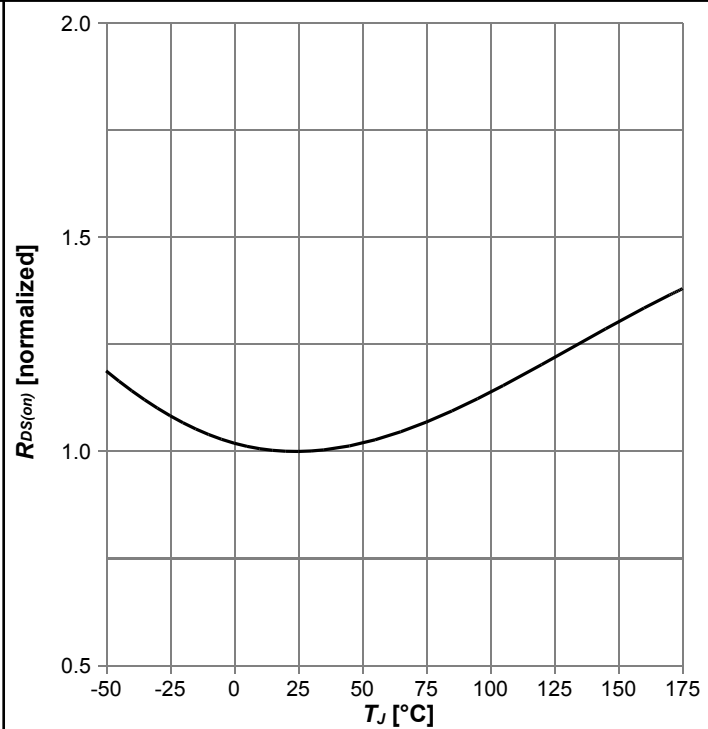

$R_{DS(on)}=f(T_j)$; $I_D=25.0\text{ A}$; $V_{GS}=18\text{ V}$

Diagram 9: Typ. transfer characteristics

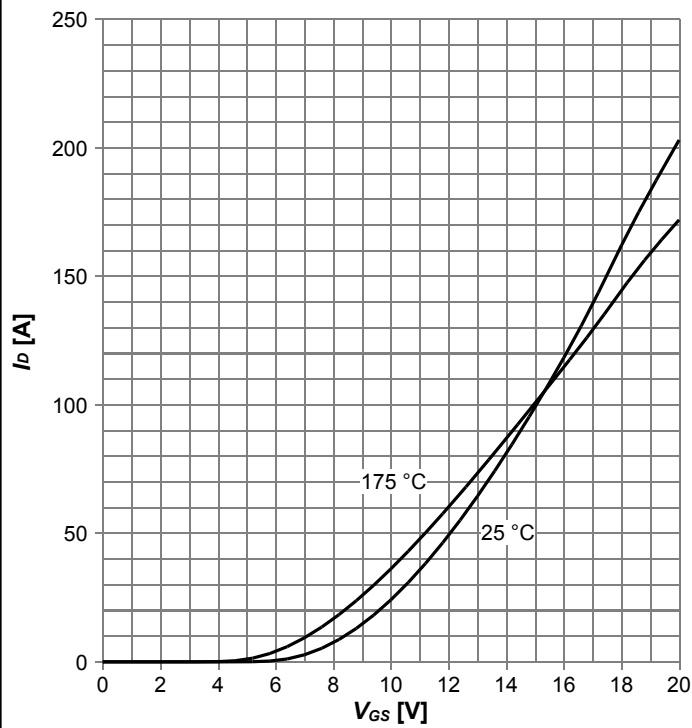

$I_D=f(V_{GS})$; $V_{DS}=20V$; parameter: T_j

Diagram 10: Typ. gate charge

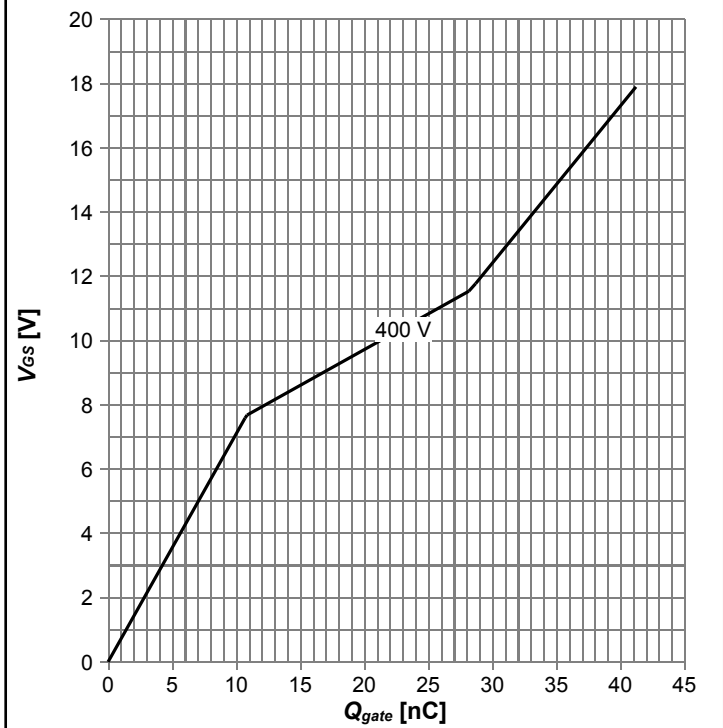

$V_{GS}=f(Q_{gate})$; $I_D=25.0$ A pulsed; parameter: V_{DD}

Diagram 11: Typ. reverse characteristics

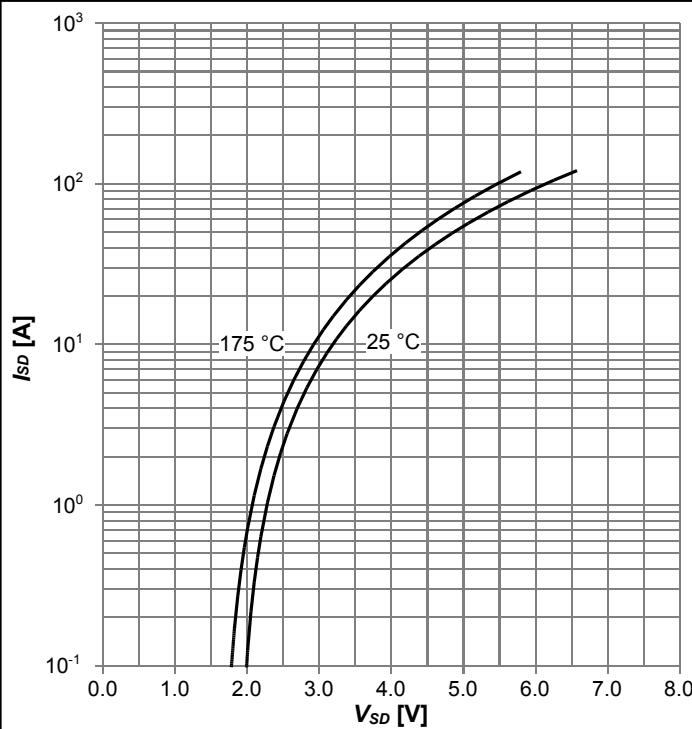

$I_{SD}=f(V_{SD})$; $V_{GS}=0$ V; parameter: T_j

Diagram 12: Typ. reverse characteristics

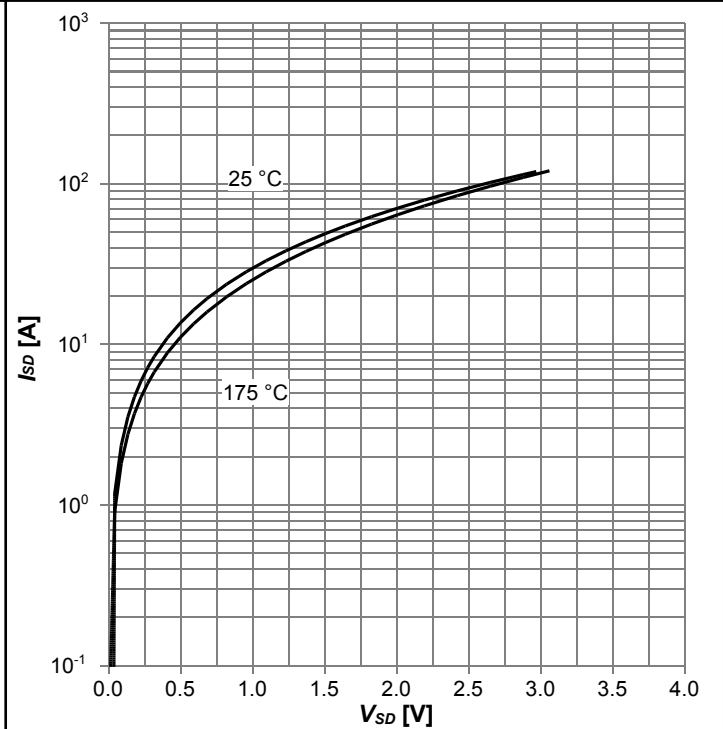

$I_{SD}=f(V_{SD})$; $V_{GS}=18$ V; parameter: T_j

Diagram 13: Avalanche energy

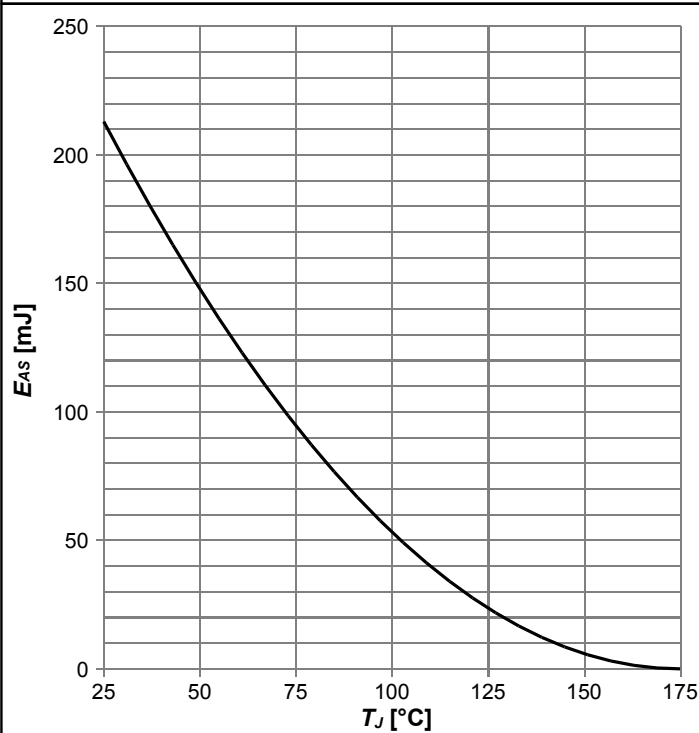

$E_{AS}=f(T_J)$; $I_D=8.0$ A; $V_{DD}=50$ V

Diagram 14: Drain-source breakdown voltage

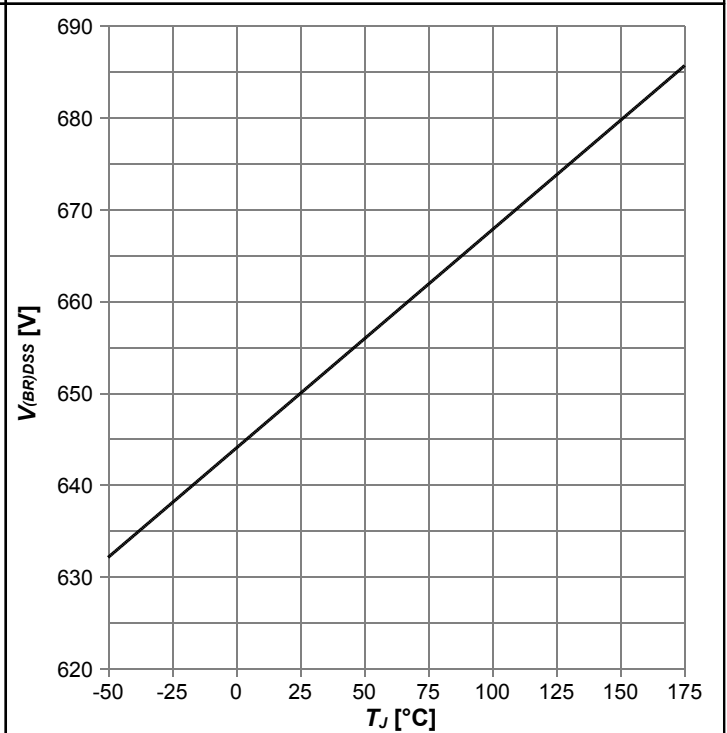

$V_{(BR)DSS}=f(T_J)$; $I_D=0.75$ mA

Diagram 15: Typ. capacitances

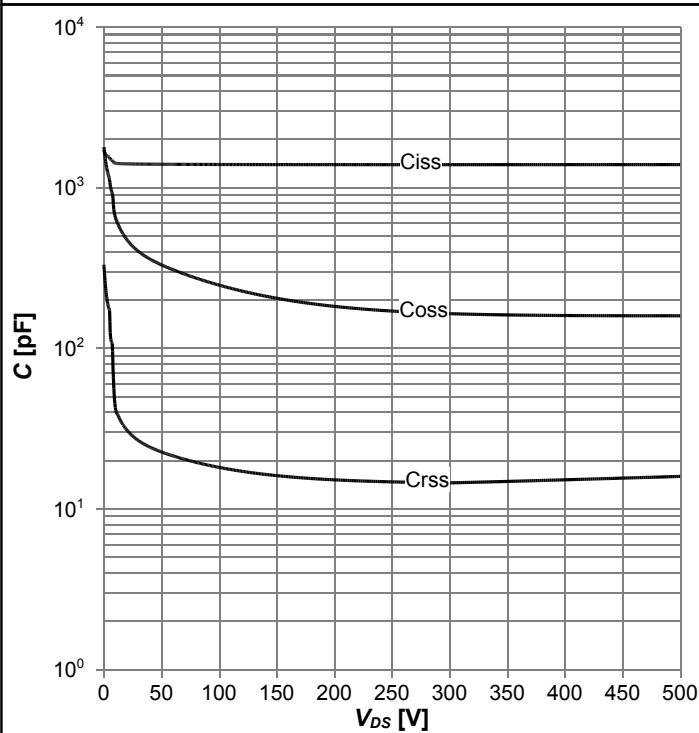

$C=f(V_{DS})$; $V_{GS}=0$ V; $f=250$ kHz

Diagram 16: Typ. Coss stored energy

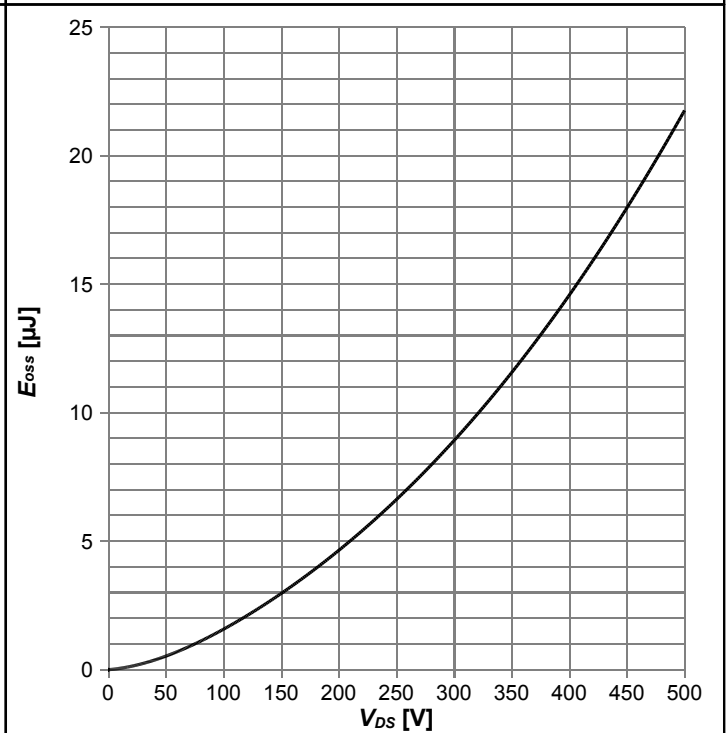

$E_{oss}=f(V_{DS})$

Diagram 17: Typ. Q_{oss} output charge

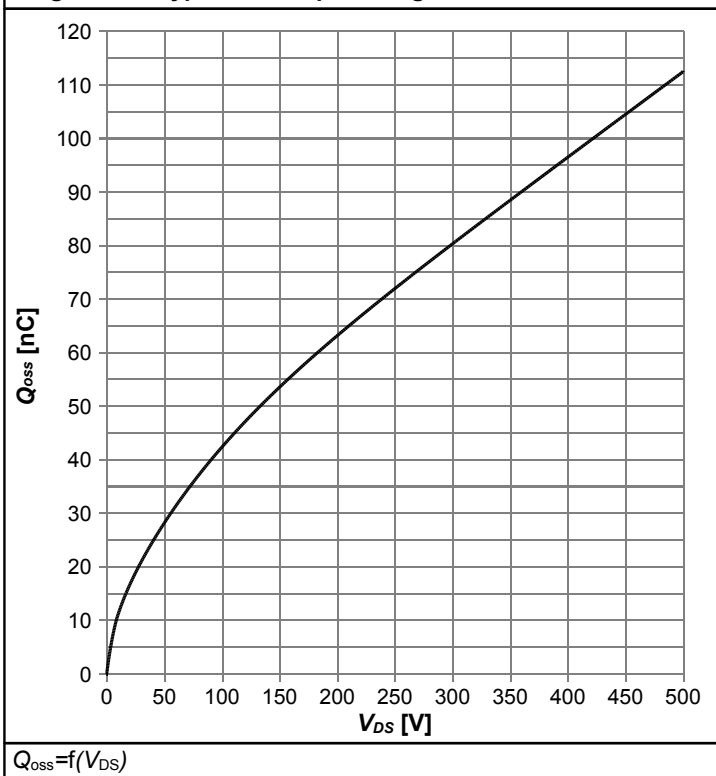

6 Test Circuits

Table 9 Body diode characteristics (650V CoolSiC)

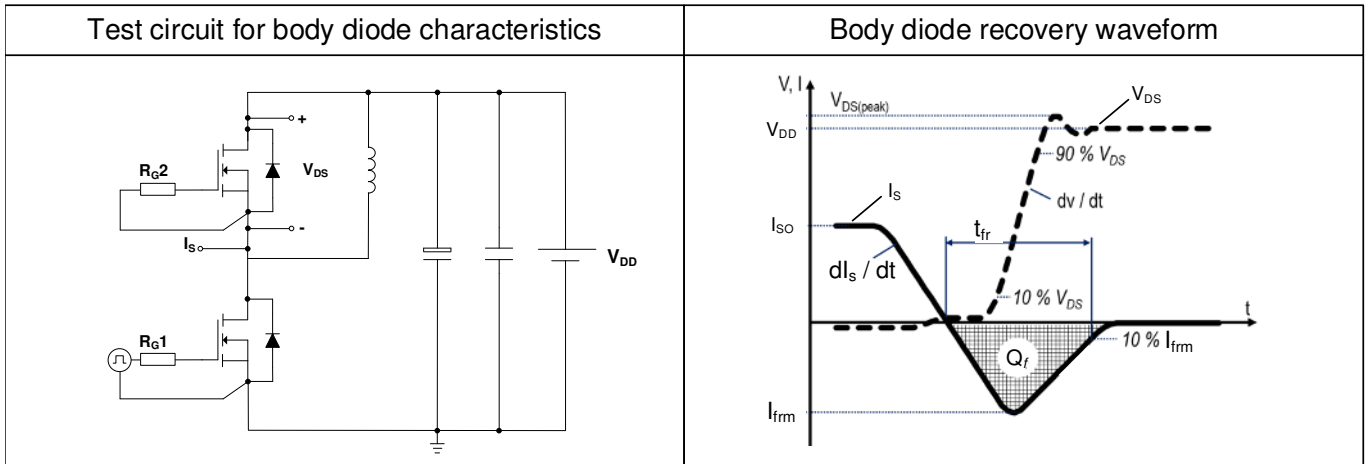

Table 10 Switching times (650V CoolSiC)

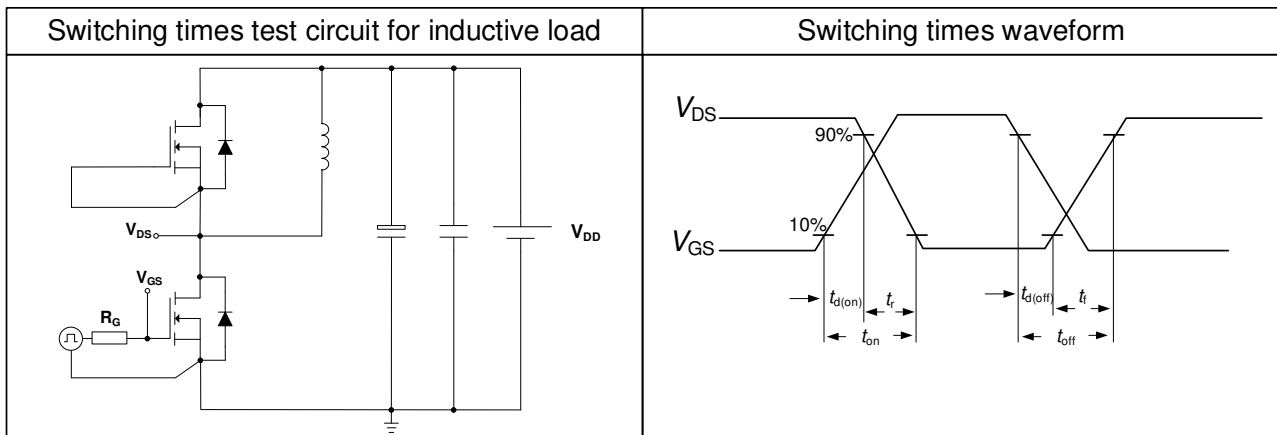
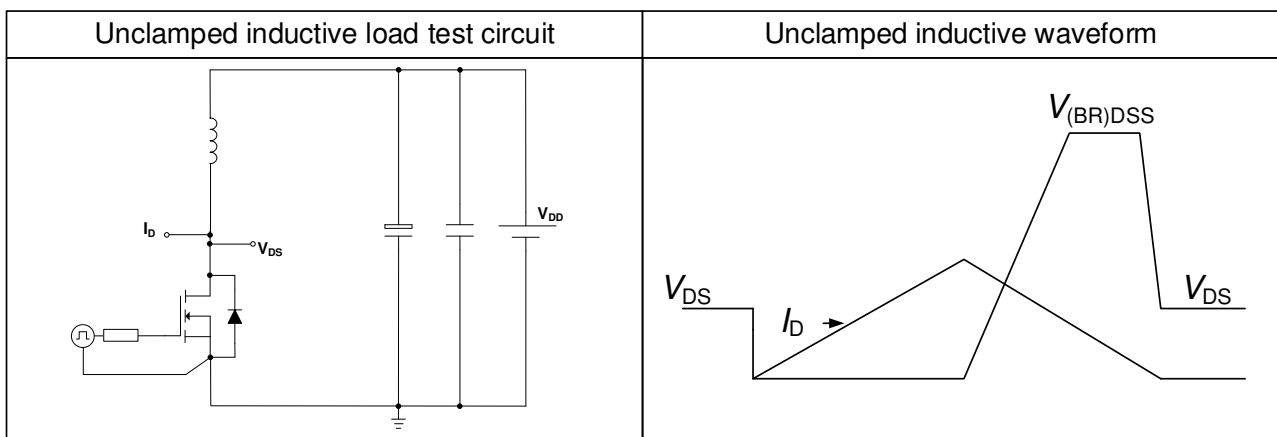

Table 11 Unclamped inductive load (650V CoolSiC)



7 Package Outlines

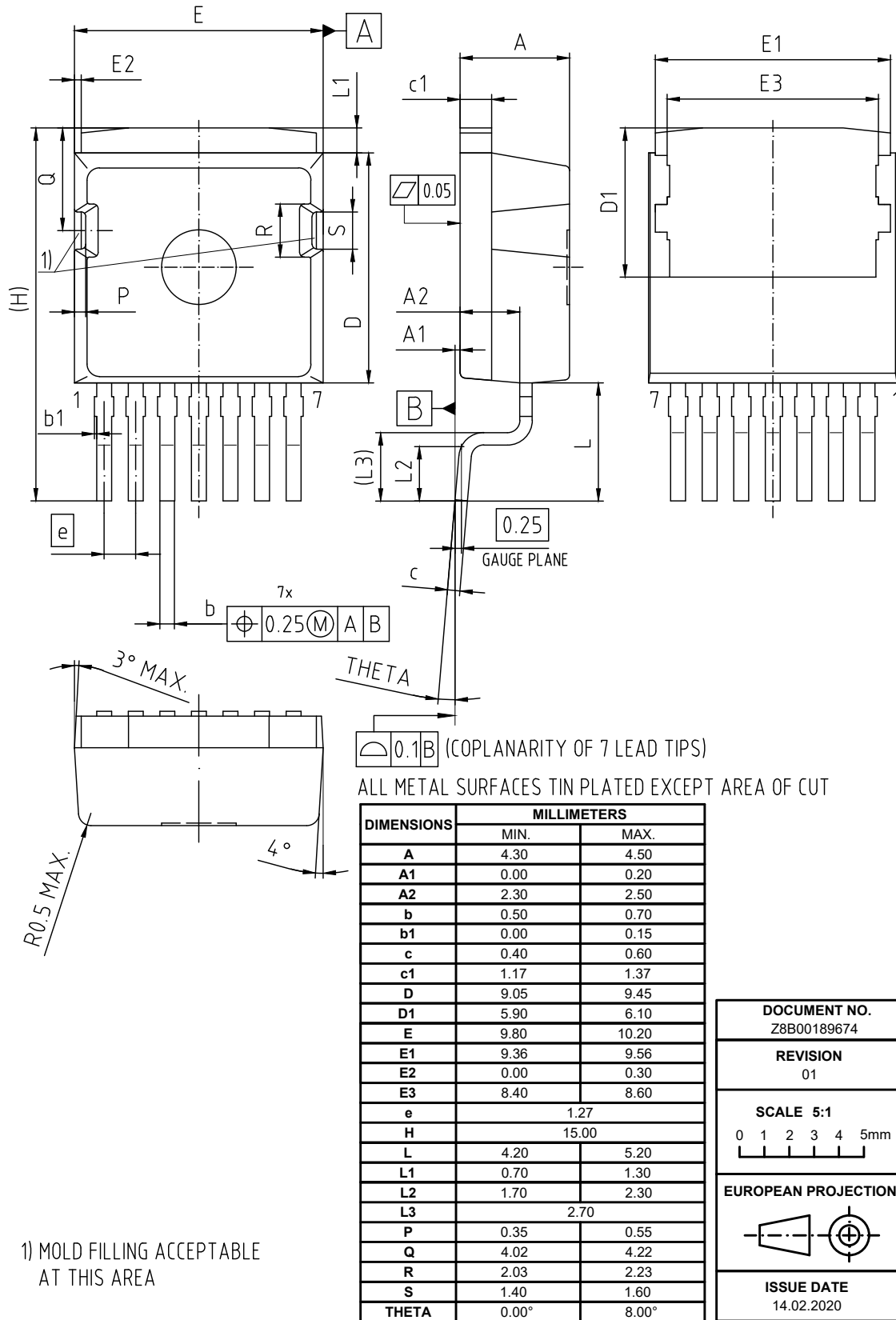

Figure 1 Outline PG-TO263-7-12, dimensions in mm

8 Appendix A

Table 12 Related Links

- **IFX CoolSiC M1 Webpage:** www.infineon.com
- **IFX CoolSiC M1 application note:** www.infineon.com
- **IFX CoolSiC M1 simulation model:** www.infineon.com
- **IFX Design tools:** www.infineon.com

Revision History

IMBG65R039M1H

Revision: 2021-12-10, Rev. 2.0

Previous Revision

Revision	Date	Subjects (major changes since last revision)
2.0	2021-12-10	Release of final version

Trademarks

All referenced product or service names and trademarks are the property of their respective owners.

We Listen to Your Comments

Any information within this document that you feel is wrong, unclear or missing at all? Your feedback will help us to continuously improve the quality of this document. Please send your proposal (including a reference to this document) to:

erratum@infineon.com

Published by

Infineon Technologies AG

81726 München, Germany

© 2021 Infineon Technologies AG

All Rights Reserved.

Legal Disclaimer

The information given in this document shall in no event be regarded as a guarantee of conditions or characteristics ("Beschaffenheitsgarantie").

With respect to any examples, hints or any typical values stated herein and/or any information regarding the application of the product, Infineon Technologies hereby disclaims any and all warranties and liabilities of any kind, including without limitation warranties of non-infringement of intellectual property rights of any third party.

In addition, any information given in this document is subject to customer's compliance with its obligations stated in this document and any applicable legal requirements, norms and standards concerning customer's products and any use of the product of Infineon Technologies in customer's applications.

The data contained in this document is exclusively intended for technically trained staff. It is the responsibility of customer's technical departments to evaluate the suitability of the product for the intended application and the completeness of the product information given in this document with respect to such application.

Information

For further information on technology, delivery terms and conditions and prices please contact your nearest Infineon Technologies Office (www.infineon.com).

Warnings

Due to technical requirements, components may contain dangerous substances. For information on the types in question, please contact the nearest Infineon Technologies Office.

The Infineon Technologies component described in this Data Sheet may be used in life-support devices or systems and/or automotive, aviation and aerospace applications or systems only with the express written approval of Infineon Technologies, if a failure of such components can reasonably be expected to cause the failure of that life-support, automotive, aviation and aerospace device or system or to affect the safety or effectiveness of that device or system. Life support devices or systems are intended to be implanted in the human body or to support and/or maintain and sustain and/or protect human life. If they fail, it is reasonable to assume that the health of the user or other persons may be endangered.