



MIC26603 Evaluation Board

28V, 6A HyperLight Load[®]
Synchronous DC-DC Buck Regulator

SuperSwitcher IIG™

General Description

The MIC26603 DC-DC regulator operates over an input supply range of 4.5V to 28V and provides a regulated output at up to 6A of output current. The output voltage is adjustable to 0.8V with a typical accuracy of $\pm 1\%$, and the device operates at a switching frequency of 600kHz. The switching frequency remains fairly constant with changes in input voltage and output load.

Micrel's Hyper Light Load™ architecture provides the same high-efficiency and ultra-fast transient response as the Hyper Speed Control™ architecture under medium to heavy loads, but also maintains high efficiency under light load conditions by transitioning to variable frequency, discontinuous mode operation.

The MIC26603 utilizes an adaptive T_{ON} ripple control architecture. An undervoltage lockout feature is provided to ensure proper operation under power-sag conditions. An internal soft-start feature is provided to reduce the inrush current. Foldback current limit and "hiccup" mode short-circuit protection and thermal shutdown ensures protection of the IC during fault conditions.

Note: This evaluation board is for 6A applications.

The datasheet and supporting documentation can be found on Micrel's web site at: www.micrel.com.

Requirements

The MIC26603 provides a 5V regulated output for input voltage V_{IN} ranging from 5.5V to 28V. When $V_{IN} < 5.5V$, VDD should be tied to PVIN pins to bypass the internal linear regulator by a jumper. The output load can either be an active or passive load.

Precautions

The evaluation board does not have reverse polarity protection. Applying a negative voltage to the V_{IN} terminal may damage the device. In addition, the maximum V_{IN} operating voltage of the MIC26603 evaluation board is 28V. Exceeding 29V on V_{IN} could damage the device capacitance and also makes (High V_{IN})/(Low V_{OUT}).

Getting Started

- 1. Connect an external supply to the V_{IN} terminal.** Apply the desired input voltage to the V_{IN} and ground terminals of the evaluation board, paying careful attention to polarity and supply voltage. An ammeter may be placed between the input supply and the V_{IN} terminal to the evaluation board. Ensure that the supply voltage is monitored at the V_{IN} terminal. The ammeter and/or power lead resistance can reduce the voltage supplied to the input.
- 2. Connect the load to the V_{OUT} and ground terminals.** The load can be either passive (resistive) or active (as in an electronic load). An ammeter can be placed between the load and the V_{OUT} terminal. Ensure that the output voltage is monitored at the V_{OUT} terminal. V_{OUT} can be set to 0.9V, 1.0V, 1.2V, 1.5V, 1.8V, 2.5V, 3.3V, or 5.0V by a jumper. If a different voltage is needed, it can be adjusted by changing the feedback resistors. See "Output Voltage" section.
- 3. Enable the MIC26603.** The EN pin is provided on the evaluation board. The output of the MIC26603 turns on when V_{DD} exceeds the UVLO threshold. The output of the MIC26603 may be turned off by shorting the EN pin to ground. A connection on the board provides easy access to the enable pin.

Ordering Information

Part Number	Description
MIC26603YJL EV	6A HLL DC-DC Regulator Evaluation Board

Output Voltage

The output voltage on the MIC26603 evaluation board is adjustable. It is set by adjusting the feedback resistors (R4 and one of R5, R6, R7, R8, R9, R10, R11, or R12) and can be calculated as follows as an example:

$$V_{OUT} = V_{REF} \times \left(1 + \frac{R4}{R7}\right)$$

where $V_{REF} = 0.8V$.

The output voltage above is set at the factory for a 1.2V output, but it can easily be changed by moving the jumper to a respective position to get an indicated voltage on the board. If a desired voltage is not shown on the board, it is easily modified by removing R4 and R7 and replacing them with the values that yield the desired output voltage.

Once R4 is selected, R7 can be calculated using:

$$R7 = \frac{R4 \times V_{REF}}{V_{OUT} - V_{REF}}$$

For $V_{REF} = 0.8V$:

$$R7 = \frac{R4 \times 0.8V}{V_{OUT} - 0.8V}$$

The output voltage should not be set to exceed 5V due to the 6.3V rating of the output capacitor and limitation on line regulation. Please refer to the MIC26603 datasheet "Setting Output Voltage" section for more information.

Evaluation Board Performance

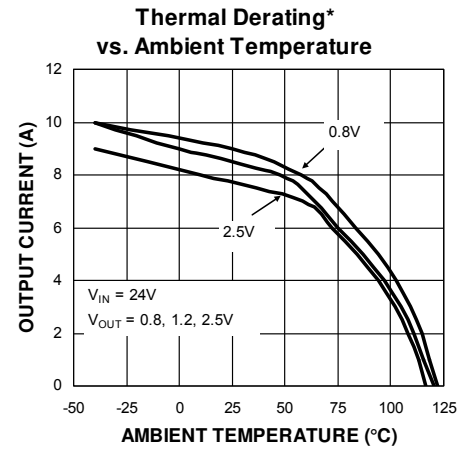
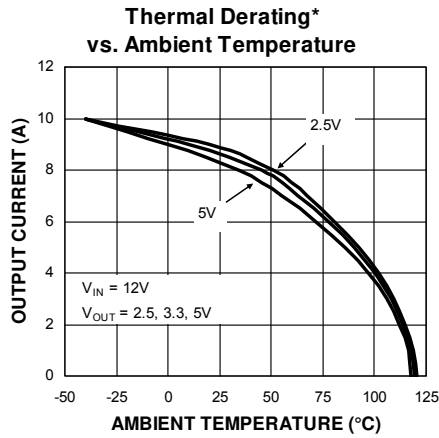
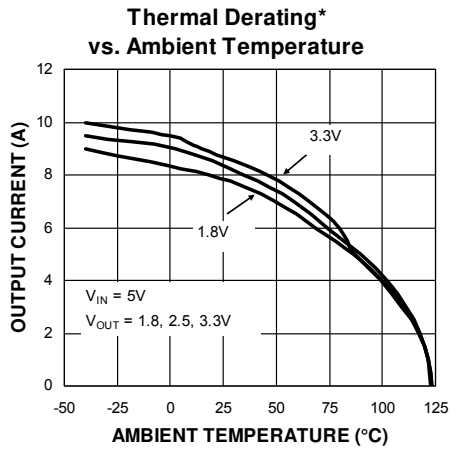
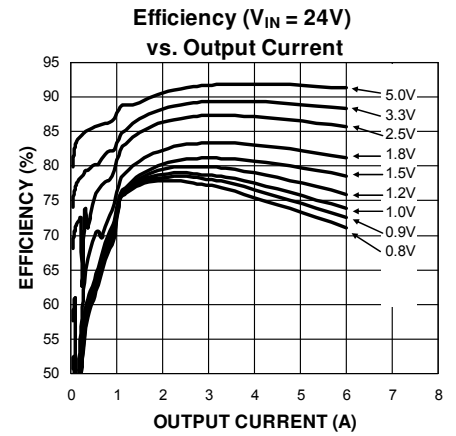
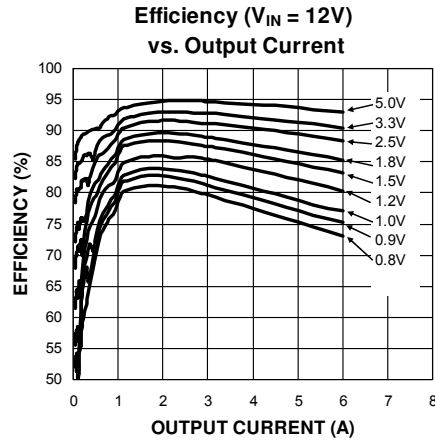
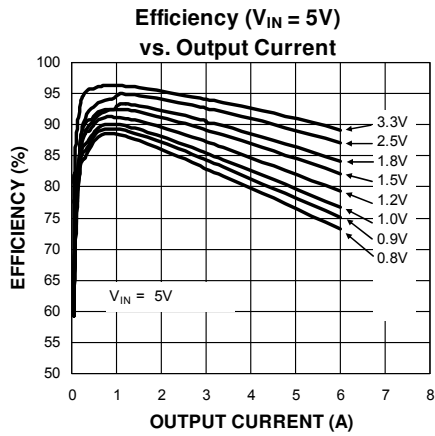

Die Temperature* : The temperature measurement was taken at the hottest point on the MIC26603 case mounted on a 5 square inch 4 layer, 0.62", FR-4 PCB with 2oz finish copper weight per layer, see Thermal Measurement section. Actual results will depend upon the size of the PCB, ambient temperature and proximity to other heat emitting components.

Evaluation Board Schematic

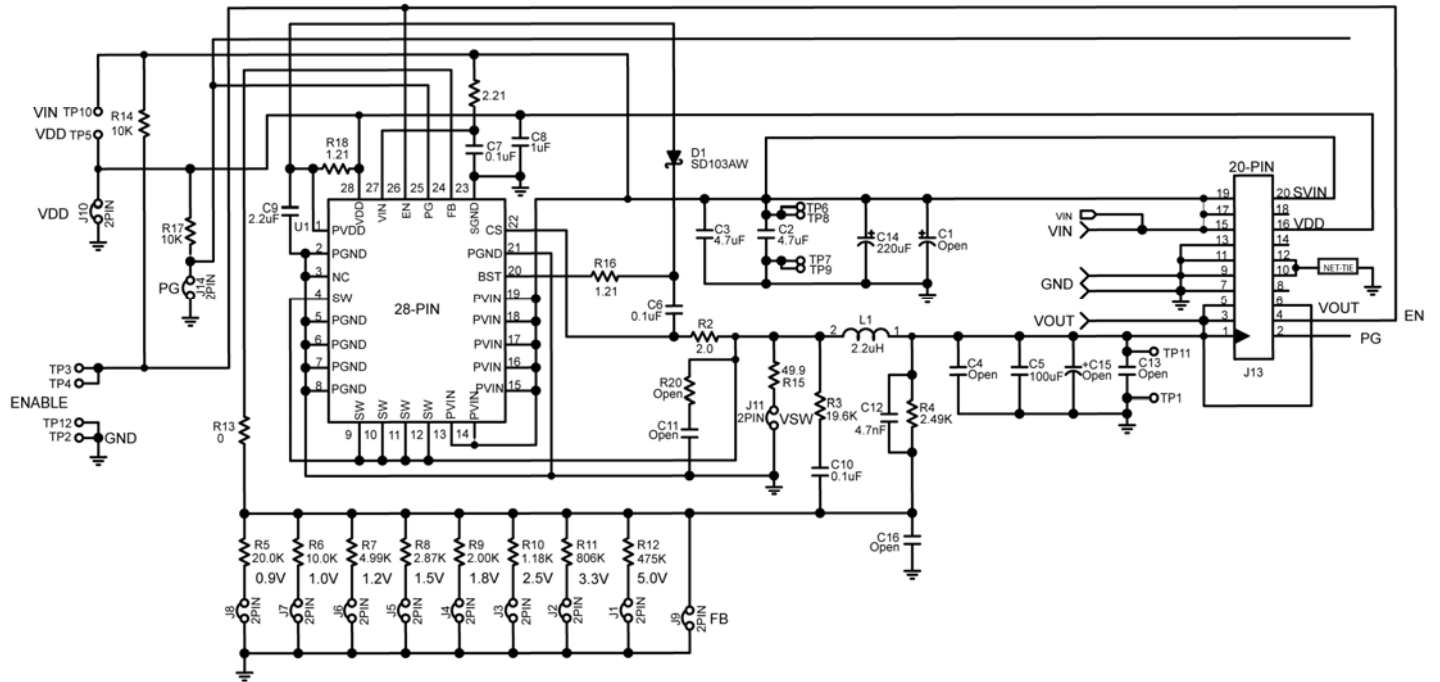

**Schematic of MIC26603 Evaluation Board
(J11, R13, R15 are for testing purposes)**

Bill of Materials

Item	Part Number	Manufacturer	Description	Qty
C1	Open			
C2, C3	12105C475KAZ2A	AVX ⁽¹⁾	4.7µF Ceramic Capacitor, X7R, Size 1210, 50V	2
	GRM32ER71H475KA88L	Murata ⁽²⁾		
	C3225X7R1H475K	TDK ⁽³⁾		
C4, C5	Open			
C13	12106D107MAT2A	AVX ⁽¹⁾	100µF Ceramic Capacitor, X5R, Size 1210, 6.3V	3
	GRM32ER60J107ME20L	Murata ⁽²⁾		
	C3225X5R0J107M	TDK ⁽³⁾		
C6, C7, C10	06035C104KAT2A	AVX ⁽¹⁾	0.1µF Ceramic Capacitor, X7R, Size 0603, 50V	3
	GRM188R71H104KA93D	Murata ⁽²⁾		
	C1608X7R1H104K	TDK ⁽³⁾		
C8	0805ZC225MAT2A	AVX ⁽¹⁾	1.0µF Ceramic Capacitor, X7R, Size 0603, 10V	1
	GRM21BR71A225KA01L	Murata ⁽²⁾		
	C2012X7R1A225K	TDK ⁽³⁾		
C9	0805ZC225MAT2A	AVX ⁽¹⁾	2.2µF Ceramic Capacitor, X7R, Size 0603, 10V	1
	GRM21BR71A225KA01L	Murata ⁽²⁾		
	C2012X7R1A225K	TDK ⁽³⁾		
C12	06035C223KAZ2A	AVX ⁽¹⁾	4.7nF Ceramic Capacitor, X7R, Size 0603, 50V	1
	GRM188R71H223K	Murata ⁽²⁾		
	C1608X7R1H223K	TDK ⁽³⁾		
C14	B41851F7227M	EPCOS ⁽⁴⁾	220µF Aluminum Capacitor, 35V	1
C15	Open			
D1	SD103AWS	MCC ⁽⁵⁾	40V, 350mA.Schottky Diode. SOD323	1
	SD103AWS-7	Diodes Inc ⁽⁶⁾		
	SD103AWS	Vishay ⁽⁷⁾		
D2	BAT46W	MCC ⁽⁵⁾	100V, 150mA.Schottky Diode. SOD123	1
	BAT46W	Diodes Inc ⁽⁶⁾		
	BAT46W-V	Vishay ⁽⁷⁾		
L1	HCF1305-2R2-R	Cooper Bussmann ⁽⁸⁾	2.2µH Inductor, 15A Saturation Current	1
R1	CRCW06032R21FKEA	Vishay Dale ⁽⁷⁾	2.21Ω Resistor, Size 0603, 1%	1
R2	CRCW06032R00FKEA	Vishay Dale ⁽⁷⁾	2.00Ω Resistor, Size 0603, 1%	1
R3	CRCW060319K6FKEA	Vishay Dale ⁽⁷⁾	19.6kΩ Resistor, Size 0603, 1%	1
R4	CRCW06032K49FKEA	Vishay Dale ⁽⁷⁾	2.49kΩ Resistor, Size 0603, 1%	1
R5	CRCW060320K0FKEA	Vishay Dale ⁽⁷⁾	20.0kΩ Resistor, Size 0603, 1%	1
R6, R14, R17	CRCW060310K0FKEA	Vishay Dale ⁽⁷⁾	10.0kΩ Resistor, Size 0603, 1%	3
R7	CRCW06034K99FKEA	Vishay Dale ⁽⁷⁾	4.99kΩ Resistor, Size 0603, 1%	1
R8	CRCW06032K87FKEA	Vishay Dale ⁽⁷⁾	2.87kΩ Resistor, Size 0603, 1%	1
R9	CRCW06032K006FKEA	Vishay Dale ⁽⁷⁾	2.00kΩ Resistor, Size 0603, 1%	1
R10	CRCW06031K18FKEA	Vishay Dale ⁽⁷⁾	1.18kΩ Resistor, Size 0603, 1%	1

Bill of Materials (Continued)

Item	Part Number	Manufacturer	Description	Qty
R11	CRCW0603806RFKEA	Vishay Dale ⁽⁷⁾	806Ω Resistor, Size 0603, 1%	1
R12	CRCW0603475RFKEA	Vishay Dale ⁽⁷⁾	475Ω Resistor, Size 0603, 1%	1
R13	CRCW06030000FKEA	Vishay Dale ⁽⁷⁾	0Ω Resistor, Size 0603, 5%	1
R15	CRCW060349R9FKEA	Vishay Dale ⁽⁷⁾	49.9Ω Resistor, Size 0603, 1%	1
R16, R18	CRCW06031R21FKEA	Vishay Dale ⁽⁷⁾	1.21Ω Resistor, Size 0603, 1%	2
U1	MIC26603YJL	Micrel, Inc.⁽⁹⁾	28V/6A Synchronous Buck DC-DC Regulator	1

Notes:

1. AVX: www.avx.com
2. Murata: www.murata.com/
3. TDK: www.tdk.com
4. EPCOS: www.epcos.com
5. MCC: www.mcc.com
6. Diode Inc.: www.diodes.com
7. Vishay: www.vishay.com
8. Cooper Bussmann: www.cooperbussmann.com
9. Micrel, Inc.: www.micrel.com

PCB Layout Recommendations

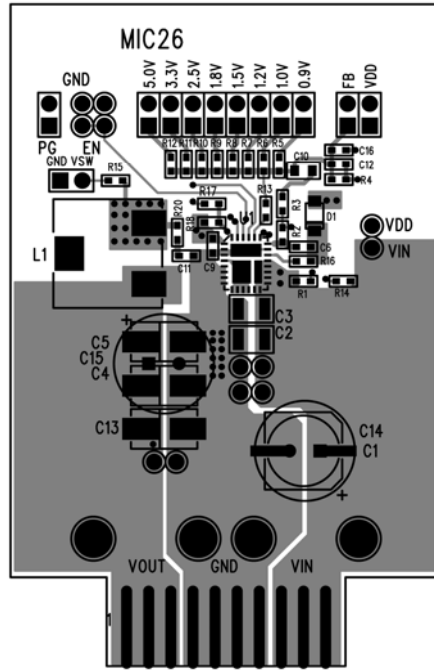

Top Layer

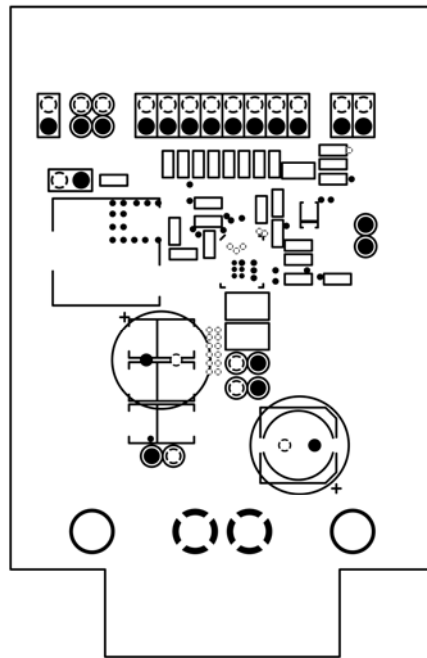

Mid-Layer 1 (Ground Plane)

PCB Layout Recommendations (Continued)

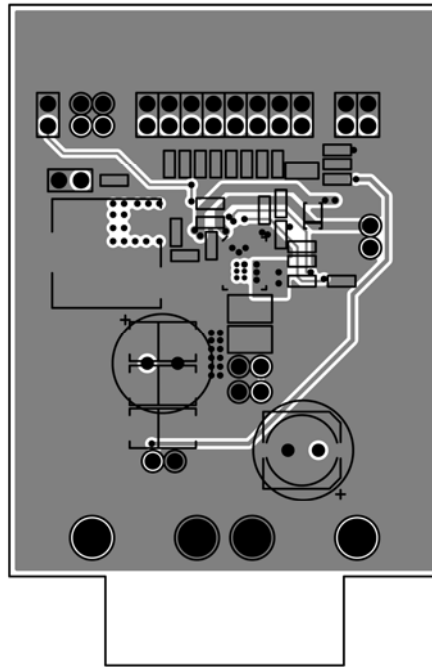

Mid-Layer 2

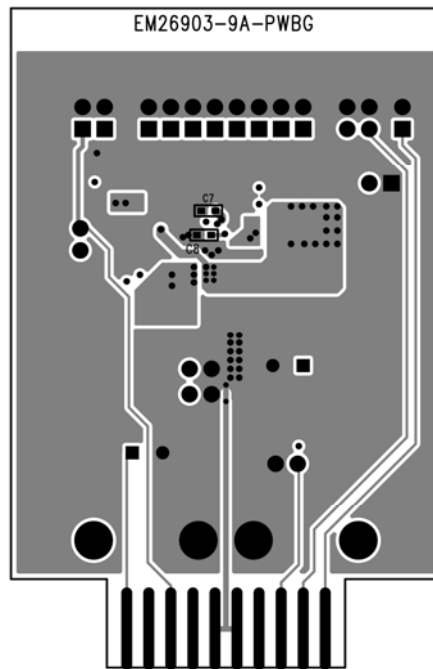

Bottom Layer

MICREL, INC. 2180 FORTUNE DRIVE SAN JOSE, CA 95131 USA
TEL +1 (408) 944-0800 FAX +1 (408) 474-1000 WEB <http://www.micrel.com>

Micrel makes no representations or warranties with respect to the accuracy or completeness of the information furnished in this data sheet. This information is not intended as a warranty and Micrel does not assume responsibility for its use. Micrel reserves the right to change circuitry, specifications and descriptions at any time without notice. No license, whether express, implied, arising by estoppel or otherwise, to any intellectual property rights is granted by this document. Except as provided in Micrel's terms and conditions of sale for such products, Micrel assumes no liability whatsoever, and Micrel disclaims any express or implied warranty relating to the sale and/or use of Micrel products including liability or warranties relating to fitness for a particular purpose, merchantability, or infringement of any patent, copyright or other intellectual property right.

Micrel Products are not designed or authorized for use as components in life support appliances, devices or systems where malfunction of a product can reasonably be expected to result in personal injury. Life support devices or systems are devices or systems that (a) are intended for surgical implant into the body or (b) support or sustain life, and whose failure to perform can be reasonably expected to result in a significant injury to the user. A Purchaser's use or sale of Micrel Products for use in life support appliances, devices or systems is a Purchaser's own risk and Purchaser agrees to fully indemnify Micrel for any damages resulting from such use or sale.

© 2011 Micrel, Incorporated.