

LTE MIMO Combination Antenna JCG010LM

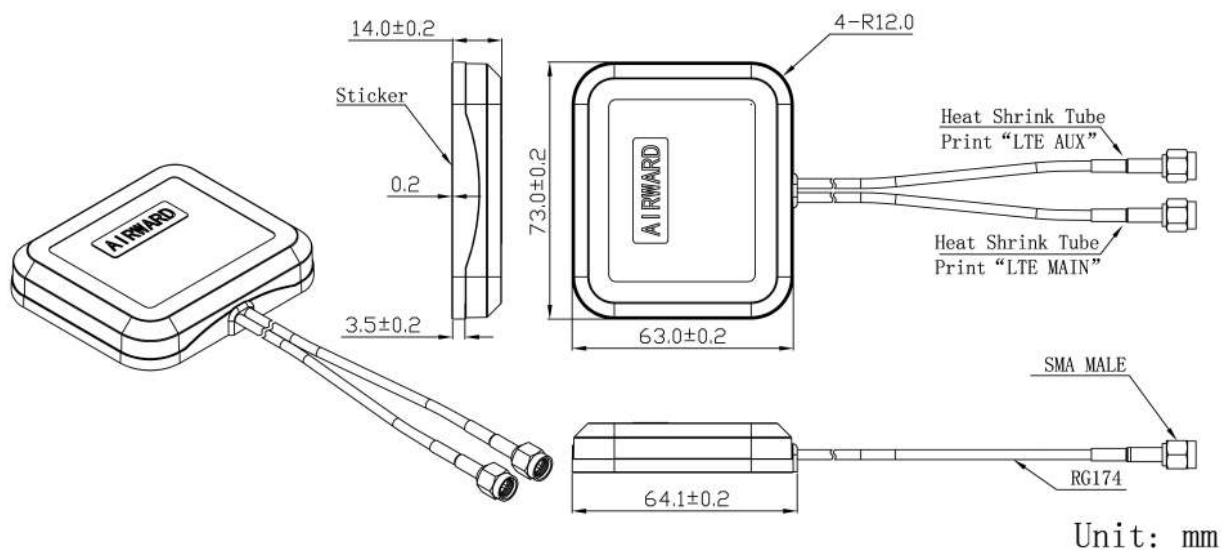

DIMENSIONS





Jinchang Electron Global Service

SPECIFICATIONS

Item		Specifications
LTE Antenna MAIN	Frequency Range	698~960MHz/1710~2690MHz
	V.S.W.R	<3.0
	Polarization	Linear
	Gain	2.5dBi (Zenith)
	Impedance	50Ω
LTE Antenna AUX	Frequency Range	698~960MHz/1710~2690MHz
	V.S.W.R	<3.0
	Polarization	Linear
	Gain	2.0dBi (Zenith)
	Impedance	50Ω
Mechanical	Cable	RG174
	Connector	SMA or others
	Material	ABS
	Mounting Method	Adhesive/Magnet
Environmental	Operating Temperature	-40°C~+85°C
	Relative Humidity	Up to 95%
	Vibration	10 to 55Hz with 1.5mm amplitude 2hours
	Environmentally Friendly	ROHS Compliant

JIAXING JINCHANG ELECTRONIC TECHNOLOGY CO.,LTD

Add: 398#,Zhenye Road, South Street, Jiaxing, Zhejiang, China

Http://www.jinchanggps.com

E-mail:jcgps@vip.163.com

Tel: 86-0573-83692157/83692605/83958637 Fax:86-0573-83958635

Radiation Pattern

LTE Antenna MAIN

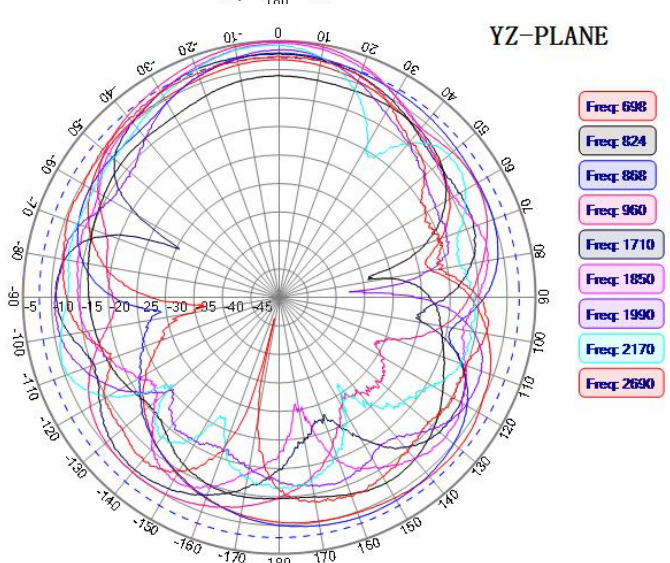
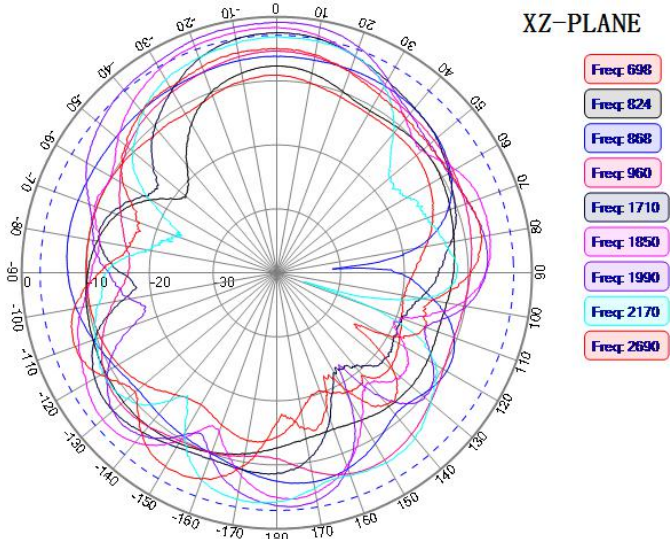
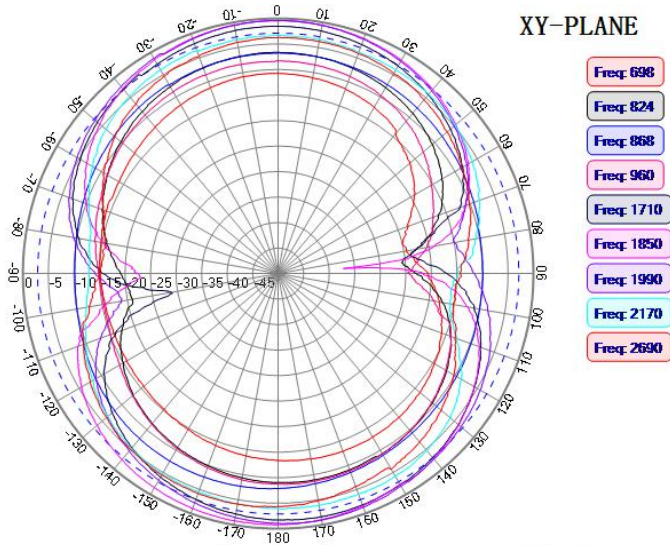

LTE Antenna AUX

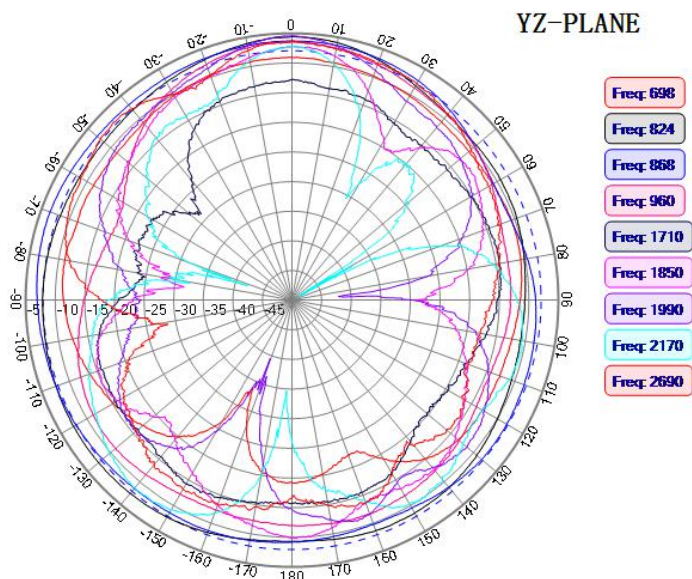
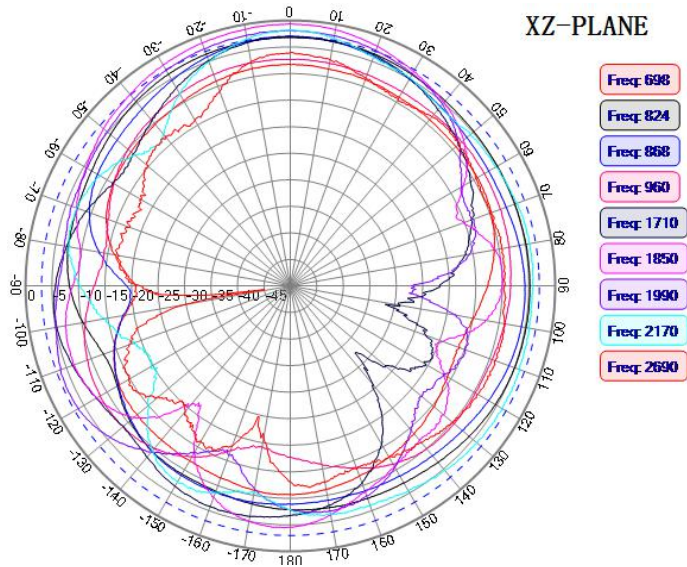
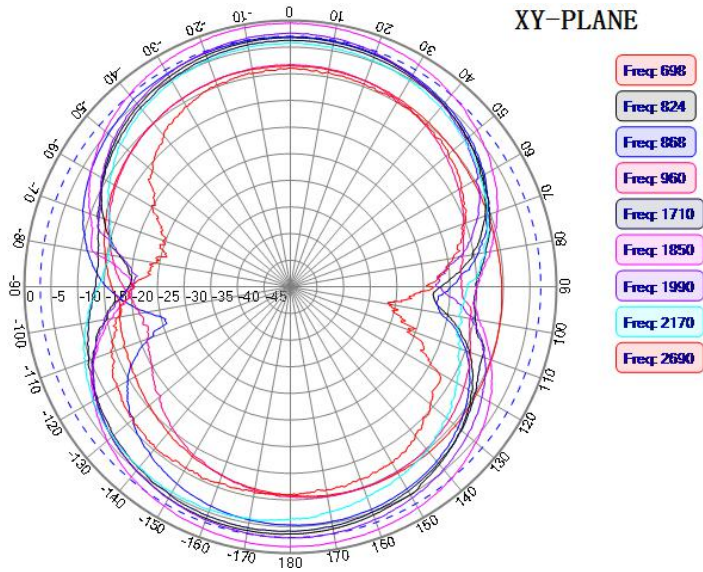

JIAXING JINCHANG ELECTRONIC TECHNOLOGY CO.,LTD

Add: 398#,Zhenye Road, South Street, Jiaxing, Zhejiang, China

Http://www.jinchanggps.com

E-mail:jcgps@vip.163.com

Tel: 86-0573-83692157/83692605/83958637 Fax:86-0573-83958635