



# NEO-M9N-00B

**Standard precision GNSS module**

**Professional grade**

Data sheet



## **Abstract**

This data sheet describes the u-blox NEO-M9N-00B GNSS module. NEO-M9N-00B offers ultra-robust meter-level GNSS positioning performance with concurrent reception of up to four GNSS (GPS, GLONASS, BeiDou, Galileo) in a 12.2 x 16.0 mm package.

[www.u-blox.com](http://www.u-blox.com)

UBX-19014285 - R07  
C1-Public



# Document information

<b>Title</b>	<b>NEO-M9N-00B</b>	
<b>Subtitle</b>	Standard precision GNSS module	
<b>Document type</b>	Data sheet	
<b>Document number</b>	UBX-19014285	
<b>Revision and date</b>	R07	27-Mar-2023
<b>Disclosure restriction</b>	C1-Public	

<b>Product status</b>	<b>Corresponding content status</b>	
<b>Functional Sample</b>	Draft	For functional testing. Revised and supplementary data will be published later.
<b>In development / prototype</b>	Objective specification	Target values. Revised and supplementary data will be published later.
<b>Engineering sample</b>	Advance information	Data based on early testing. Revised and supplementary data will be published later.
<b>Initial production</b>	Early production information	Data from product verification. Revised and supplementary data may be published later.
<b>Mass production / End of life</b>	Production information	Document contains the final product specification.

This document applies to the following products:

<b>Product name</b>	<b>Type number</b>	<b>FW version</b>	<b>IN/PCN reference</b>	<b>Product status</b>
NEO-M9N	NEO-M9N-00B-00	SPG 4.04	UBX-21029274 UBX-22039049 UBX-23000084	Mass production

u-blox or third parties may hold intellectual property rights in the products, names, logos and designs included in this document. Copying, reproduction, or modification of this document or any part thereof is only permitted with the express written permission of u-blox. Disclosure to third parties is permitted for clearly public documents only.

The information contained herein is provided "as is" and u-blox assumes no liability for its use. No warranty, either express or implied, is given, including but not limited to, with respect to the accuracy, correctness, reliability and fitness for a particular purpose of the information. This document may be revised by u-blox at any time without notice. For the most recent documents, visit [www.u-blox.com](http://www.u-blox.com).

Copyright © 2023, u-blox AG.

# Contents

<b>1 Functional description.....</b>	<b>4</b>
1.1 Overview.....	4
1.2 Performance.....	4
1.3 Supported GNSS constellations.....	5
1.4 Supported protocols.....	6
1.5 Firmware features.....	6
<b>2 System description.....</b>	<b>7</b>
2.1 Block diagram.....	7
<b>3 Pin definition.....</b>	<b>8</b>
3.1 Pin assignment.....	8
<b>4 Electrical specification.....</b>	<b>10</b>
4.1 Absolute maximum ratings.....	10
4.2 Operating conditions.....	10
4.3 Indicative power requirements.....	11
<b>5 Communications interfaces.....</b>	<b>12</b>
5.1 UART.....	12
5.2 SPI.....	12
5.3 I2C.....	13
5.4 USB.....	15
5.5 Default interface settings.....	15
<b>6 Mechanical specification.....</b>	<b>16</b>
<b>7 Reliability tests and approvals.....</b>	<b>18</b>
7.1 Approvals.....	18
<b>8 Labeling and ordering information.....</b>	<b>19</b>
8.1 Product labeling.....	19
8.2 Explanation of product codes.....	19
8.3 Ordering codes.....	19
<b>Related documents.....</b>	<b>20</b>
<b>Revision history.....</b>	<b>21</b>

# 1 Functional description

## 1.1 Overview

The NEO-M9N-00B GNSS receiver features the u-blox M9 standard precision GNSS platform . It provides exceptional sensitivity and acquisition times for all L1 GNSS systems. u-blox M9 receivers are available in different variants to serve automotive and industrial tracking applications, such as navigation, telematics and UAVs.

u-blox M9 receivers support concurrent reception of four GNSS. The high number of visible satellites allows the receiver to select the best signals. This maximizes the position accuracy, in particular under challenging conditions such as deep urban canyons.

u-blox M9 receivers detect jamming and spoofing events and report them to the host, which allows the system to react to such events. Advanced filtering algorithms mitigate the impact of RF interference and jamming, thus enabling the product to operate as intended. NEO-M9N-00B supports active GNSS in-band filtering that can operate in fixed or adaptive mode for tracking and removal of fast moving or sweeping jammers.

The receiver also provides higher navigation rate and improved security features compared to previous u-blox GNSS generations.

The NEO-M9N-00B module is available in the NEO form factor, which is a 12.2 x 16.0 mm LCC package.

## 1.2 Performance

Parameter	Specification	
Receiver type	Multi-constellation GNSS standard precision receiver	
Accuracy of time pulse signal	RMS	30 ns
	99%	60 ns
Frequency of time pulse signal	0.25 Hz to 10 MHz (configurable)	
Operational limits <sup>1</sup>	Dynamics	≤ 4 g
	Altitude	80,000 m
	Velocity	500 m/s
Velocity accuracy <sup>2</sup>	0.05 m/s	
Dynamic heading accuracy <sup>2</sup>	0.3 deg	

GNSS		GPS+GLO+GAL+BDS	GPS+GLO+GAL	GPS+GLO	GPS+BDS	GPS+GAL
Acquisition <sup>3</sup>	Cold start	24 s	25 s	26 s	28 s	29 s
	Hot start	2 s	2 s	2 s	2 s	2 s
	Aided start <sup>4</sup>	2 s	2 s	2 s	2 s	2 s
Max navigation update rate	PVT	25 Hz	25 Hz	25 Hz	25 Hz	25 Hz

<sup>1</sup> Assuming Airborne 4 g platform

<sup>2</sup> 50% at 30 m/s for dynamic operation

<sup>3</sup> Commanded starts. All satellites at -130 dBm. GPS always in combination with QZSS and SBAS. Measured at room temperature.

<sup>4</sup> Dependent on the speed and latency of the aiding data connection, commanded starts.

GNSS		GPS+GLO+GAL+BDS	GPS+GLO+GAL	GPS+GLO	GPS+BDS	GPS+GAL
Sensitivity <sup>5</sup>	Tracking and nav.	-167 dBm	-167 dBm	-167 dBm	-166 dBm	-166 dBm
	Reacquisition	-160 dBm	-160 dBm	-160 dBm	-160 dBm	-160 dBm
	Cold start	-148 dBm	-148 dBm	-148 dBm	-148 dBm	-148 dBm
	Hot start	-159 dBm	-159 dBm	-159 dBm	-159 dBm	-159 dBm
Position accuracy	PVT	2.0 m CEP	2.0 m CEP	2.0 m CEP	2.0 m CEP	2.0 m CEP

**Table 1: NEO-M9N-00B typical performance in multi-constellation GNSS modes**

GNSS		GPS	GLONASS	BEIDOU	GALILEO
Acquisition <sup>3</sup>	Cold start	29 s	27 s	32 s	42 s
	Hot start	2 s	2 s	2 s	2 s
	Aided start <sup>4</sup>	2 s	2 s	2 s	5 s
Max navigation update rate	PVT	25 Hz	25 Hz	25 Hz	25 Hz
Sensitivity <sup>5</sup>	Tracking and nav.	-166 dBm	-166 dBm	-160 dBm	-159 dBm
	Reacquisition	-160 dBm	-156 dBm	-158 dBm	-154 dBm
	Cold start	-148 dBm	-145 dBm	-145 dBm	-140 dBm
	Hot start	-159 dBm	-156 dBm	-159 dBm	-154 dBm
Position accuracy	PVT	2.0 m CEP	4.0 m CEP	3.0 m CEP	3.0 m CEP

**Table 2: NEO-M9N-00B typical performance in single-GNSS modes**

### 1.3 Supported GNSS constellations

The NEO-M9N-00B is a concurrent GNSS receiver which can receive and track multiple GNSS systems. The NEO-M9N-00B receiver can be configured for concurrent GPS, GLONASS, Galileo and BeiDou plus SBAS and QZSS reception. If power consumption is a key factor, then the receiver can be configured for a subset of GNSS constellations.

Supported GNSS systems and their signals are:

GPS / QZSS	GLONASS	Galileo	BeiDou
L1C/A (1575.42 MHz)	L1OF (1602 MHz + $k \cdot 562.5$ kHz, $k = -7, \dots, 5, 6$ )	E1-B/C (1575.42 MHz)	B1I (1561.098 MHz)

**Table 3: Supported GNSS systems and signals**

The following GNSS assistance services can be activated:

AssistNow™ Online	AssistNow™ Offline	AssistNow™ Autonomous
Supported	Supported	Supported <sup>6</sup>

**Table 4: Supported assisted GNSS (A-GNSS) services**

NEO-M9N-00B supports the following augmentation systems:

SBAS	QZSS	IMES	Differential GNSS
EGNOS, GAGAN, MSAS and WAAS supported	L1S supported	Not supported	RTCM 3.3

**Table 5: Supported augmentation systems**

The SBAS and QZSS augmentation systems can be enabled only if GPS operation is also enabled.

<sup>5</sup> Demonstrated with a good external LNA. Measured at room temperature.

<sup>6</sup> AssistNow Autonomous is enabled by default.

## 1.4 Supported protocols

The NEO-M9N-00B supports the following protocols:

Protocol	Type
UBX	Input/output, binary, u-blox proprietary
NMEA 4.10 (default), 4.0, 2.3, and 2.1	Input/output, ASCII
RTCM 3.3	Input, binary

**Table 6: Supported protocols**

For specification of the protocols, see the Interface description [1].

## 1.5 Firmware features

Feature	Description
Assisted GNSS	AssistNow Online, AssistNow Offline and AssistNow Autonomous supported
Backup modes	Hardware backup mode, software backup mode
Data batching	Autonomous tracking up to 5 min.
Data-logger	Position, velocity, time, and odometer data
Geofencing	Up to 4 circular areas
Power save modes	On/off, cyclic
Odometer	Measure traveled distance with support for different user profiles
Upgradeable firmware	Firmware in flash memory can be upgraded

**Table 7: Firmware features**

Feature	Description
Anti-jamming	RF interference and jamming detection and reporting; Active GNSS in-band filtering
Anti-spoofing	Spoofing detection and reporting
Configuration lockdown	Receiver configuration can be locked by command
Message integrity	All messages signed with SHA-256
Secure boot	Only signed FW images executed
JTAG debug port	Locked by default

**Table 8: Security features**

## 2 System description

### 2.1 Block diagram

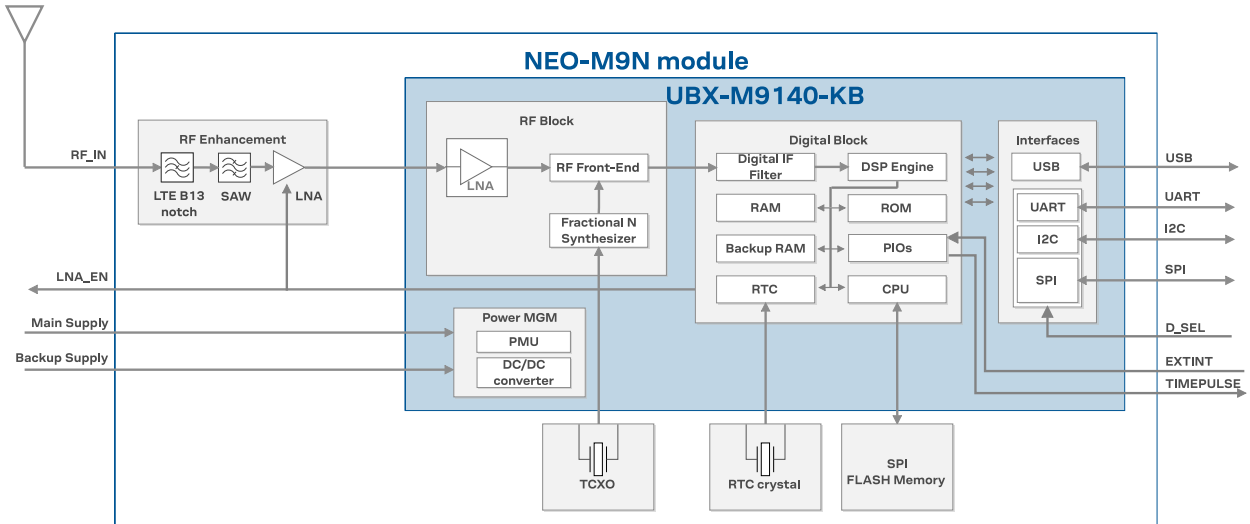

Figure 1: NEO-M9N-00B block diagram

## 3 Pin definition

### 3.1 Pin assignment

The pin assignment of the NEO-M9N-00B module is shown in [Figure 2](#). The defined configuration of the PIOs is listed in [Table 9](#).

For detailed information on pin functions and characteristics, see the integration manual [3].

<b>13</b>	GND	GND	<b>12</b>
<b>14</b>	LNA_EN	RF_IN	<b>11</b>
<b>15</b>	Reserved	GND	<b>10</b>
<b>16</b>	Reserved	VCC_RF	<b>9</b>
<b>17</b>	Reserved	RESET_N	<b>8</b>
<b>NEO-M9N Top View</b>			
<b>18</b>	SDA / SPI CS_N	V_USB	<b>7</b>
<b>19</b>	SCL / SPI SLK	USB_DP	<b>6</b>
<b>20</b>	TXD / SPI MISO	USB_DM	<b>5</b>
<b>21</b>	RXD / SPI MOSI	EXTINT	<b>4</b>
<b>22</b>	V_BCKP	TIMEPULSE	<b>3</b>
<b>23</b>	VCC	D_SEL	<b>2</b>
<b>24</b>	GND	SAFEBOOT_N	<b>1</b>

Figure 2: NEO-M9N-00B pin assignment

Pin no.	Name	I/O	Description
1	SAFEBOOT_N	I	SAFEBOOT_N (used for FW updates and reconfiguration, leave open)
2	D_SEL	I	Interface select (open or VCC = UART + I2C; GND = SPI)
3	TIMEPULSE	O	TIMEPULSE (1 PPS)
4	EXTINT	I	EXTINT (PIO 7)
5	USB_DM	I/O	USB data (DM)
6	USB_DP	I/O	USB data (DP)
7	V_USB	I	USB supply
8	RESET_N	I	RESET (active low)
9	VCC_RF	O	Voltage for external LNA
10	GND	I	Ground
11	RF_IN	I	GNSS signal input
12	GND	I	Ground
13	GND	I	Ground
14	LNA_EN	O	Antenna/LNA control
15	Reserved	-	Reserved
16	Reserved	-	Reserved



Pin no.	Name	I/O	Description
17	Reserved	-	Reserved
18	SDA / SPI CS_N	I/O	I2C data if D_SEL = VCC (or open); SPI chip select if D_SEL = GND
19	SCL / SPI SLK	I/O	I2C clock if D_SEL = VCC (or open); SPI clock if D_SEL = GND
20	TXD / SPI MISO	O	UART output if D_SEL = VCC (or open); SPI MISO if D_SEL = GND
21	RXD / SPI MOSI	I	UART input if D_SEL = VCC (or open); SPI MOSI if D_SEL = GND
22	V_BCKP	I	Backup voltage supply
23	VCC	I	Supply voltage
24	GND	I	Ground

**Table 9: NEO-M9N-00B pin assignment**



For detailed information on the pin functions and characteristics see the integration manual [3].

## 4 Electrical specification

**CAUTION** Operating the device above one or more of the limiting values may cause permanent damage to the device. The values provided in this chapter are stress ratings. Extended exposure to the values outside the limits may effect the device reliability.

Where application information is given, it is advisory only and does not form part of the specification.

For detailed information on the device integration, see the integration manual [3].

### 4.1 Absolute maximum ratings

Parameter	Symbol	Condition	Min	Max	Units
Power supply voltage	VCC		-0.5	3.6	V
Voltage ramp on VCC <sup>7</sup>			20	8000	μs/V
Backup battery voltage	V_BCKP		-0.5	3.6	V
Input pin voltage	V <sub>in</sub>	VCC ≤ 3.1 V	-0.5	VCC + 0.5	V
		VCC > 3.1 V	-0.5	3.6	V
VCC_RF output current	ICC_RF			200	mA
Supply voltage USB	V_USB		-0.5	3.6	V
USB signals	USB_DM, USB_DP		-0.5	V_USB + 0.5 V	
Input power at RF_IN	Pr <sub>fin</sub>	source impedance = 50 Ω, continuous wave		13 <sup>8</sup>	dBm
Storage temperature	T <sub>stg</sub>		-40	+85	°C

**Table 10: Absolute maximum ratings**

**CAUTION** Risk of equipment damage. This product is not protected against overvoltage or reversed voltages. Use appropriate protection diodes to avoid voltage spikes exceeding the specified boundaries damaging the equipment.

### 4.2 Operating conditions

The values for the following operating conditions have been specified at 25°C ambient temperature. Extreme operating temperatures can significantly impact the specified values. If an application operates near the min or max temperature limits, ensure the specified values are not exceeded.

Parameter	Symbol	Min	Typical	Max	Units	Condition
Power supply voltage	VCC	2.7	3.0	3.6	V	
Supply voltage for USB interface	V_USB	3.0		3.6	V	
Backup battery voltage	V_BCKP	1.65		3.6	V	
Backup battery current <sup>9</sup>	I_BCKP		45		μA	V_BCKP = 3 V, VCC = 0 V
SW backup current	I_SWBCKP		0.36		mA	
Input pin voltage range	V <sub>in</sub>	0		VCC	V	

<sup>7</sup> Exceeding the ramp speed may permanently damage the device

<sup>8</sup> +13 dBm for outband; 0 dBm for inband

<sup>9</sup> To measure the I\_BCKP the receiver should first be switched on, i.e. VCC and V\_BCKP is available. Then set VCC to 0 V while the V\_BCKP remains available. Afterward measure the current consumption at the V\_BCKP.

Parameter	Symbol	Min	Typical	Max	Units	Condition
Digital IO pin low level input voltage	V <sub>il</sub>			0.4	V	
Digital IO pin high level input voltage	V <sub>ih</sub>	0.8 * VCC			V	
Digital IO pin low level output voltage	V <sub>ol</sub>			0.4	V	I <sub>ol</sub> = 2 mA <sup>10</sup>
Digital IO pin high level output voltage	V <sub>oh</sub>	VCC - 0.4			V	I <sub>oh</sub> = 2 mA <sup>10</sup>
DC current through any digital I/O pin (except supplies)	I <sub>pin</sub>			5	mA	
Pull-up resistance for SCL, SDA	R <sub>pu</sub>	7	15	30	kΩ	
Pull-up resistance for D_SEL, RXD, TXD, SAFEBOOT_N, EXTINT	R <sub>pu</sub>	30	75	130	kΩ	
Pull-up resistance for RESET_N	R <sub>pu</sub>	7	10	13	kΩ	
Voltage at USB pins	V_USBIO	0		V_USB	V	
VCC_RF voltage	VCC_RF		VCC - 0.1		V	
VCC_RF output current	ICC_RF			50	mA	
Receiver chain noise figure <sup>11</sup>	NF <sub>tot</sub>		3.5		dB	
External gain (at RF_IN)	Ext_gain			30	dB	
Operating temperature	Topr	-40	+25	+85	°C	

**Table 11: Operating conditions**

Operation beyond the specified operating conditions can affect the device reliability.

### 4.3 Indicative power requirements

Table 12 provides examples of typical current requirements when using a cold start command. The given values are total system supply current for a possible application including RF and baseband sections.

The actual power requirements vary depending on the FW version used, external circuitry, number of satellites tracked, signal strength, type and time of start, duration, and conditions of test.

Symbol	Parameter	Conditions	GPS+GLO+GAL+BDS	GPS+GLO	GPS	Unit
I <sub>PEAK</sub>	Peak current	Acquisition	100	100	100	mA
I <sub>VCC</sub> <sup>12, 13</sup>	VCC current	Acquisition	50	43	36	mA
		Tracking (Continuous mode)	36	32	28	mA
		Tracking (Power save mode) <sup>14</sup>	21	20	19	mA

**Table 12: Currents to calculate the indicative power requirements**

All values in Table 12 are measured at 25 °C ambient temperature. SBAS and QZSS are activated in all measurements.

<sup>10</sup> TIMEPULSE has 4 mA current drive/sink capability

<sup>11</sup> Only valid for GPS

<sup>12</sup> Simulated signal, current measured at 3.0 V

<sup>13</sup> Navigation update rate 1 Hz

<sup>14</sup> Cyclic tracking operation

## 5 Communications interfaces

The NEO-M9N-00B has several communications interfaces, including UART, SPI, I2C and USB.

All the inputs have internal pull-up resistors in normal operation and can be left open if not used. All the PIOs are supplied by VCC, therefore all the voltage levels of the PIO pins are related to VCC supply voltage.

### 5.1 UART

The NEO-M9N-00B has one UART interface which supports configurable baud rates. See the integration manual [3].

Hardware flow control is not supported.

The UART1 is enabled if D\_SEL pin of the module is left open or "high".

Symbol	Parameter	Min	Max	Unit
$R_U$	Baud rate	4800	921600	bit/s
$\Delta_{Tx}$	Tx baud rate accuracy	-1%	+1%	-
$\Delta_{Rx}$	Rx baud rate tolerance	-2.5%	+2.5%	-

Table 13: NEO-M9N-00B UART specifications

### 5.2 SPI

The SPI interface is disabled by default. The SPI interface shares pins with UART and I2C and can be selected by setting D\_SEL = 0. The SPI interface can be operated in slave mode only. The maximum transfer rate using SPI is 125 kB/s and the maximum SPI clock frequency is 5.5 MHz.

The SPI timing parameters for slave operation are defined in Figure 3. Default SPI configuration is CPOL = 0 and CPHA = 0.

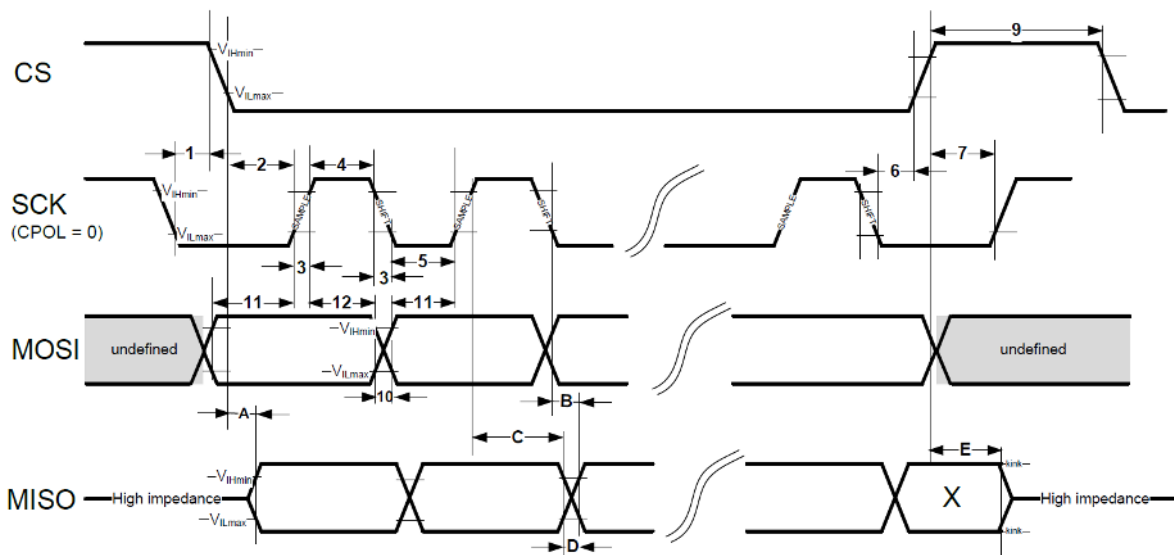

Figure 3: NEO-M9N-00B SPI specification mode 1: CPHA=0 SCK = 5.33 MHz

Symbol	Parameter	Min	Max	Unit
1	CS deassertion hold time	23	-	ns

Symbol	Parameter	Min	Max	Unit
2	Slave select time (CS to SCK)	20	-	ns
3	SCK rise/fall time	-	7	ns
4	SCK high time	24	-	ns
5	SCK low time	24	-	ns
6	Slave deselect time (SCK falling to CS)	30	-	ns
7	Slave deselect time (CS to SCK)	30	-	ns
9	CS high time	32	-	ns
10	MOSI transition time	-	7	ns
11	MOSI setup time	16	-	ns
12	MOSI hold time	24	-	ns

**Table 14: SPI slave input timing parameters 1 - 12**

Symbol	Parameter	Min	Max	Unit
A	MISO data valid time (CS)	12	40	ns
B	MISO data valid time (SCK), weak driver mode	15	40	ns
C	MISO data hold time	100	140	ns
D	MISO rise/fall time, weak driver mode	0	5	ns
E	MISO data disable lag time	15	35	ns

**Table 15: SPI slave timing parameters A - E, 2 pF load capacitance**

Symbol	Parameter	Min	Max	Unit
A	MISO data valid time (CS)	16	55	ns
B	MISO data valid time (SCK), weak driver mode	20	55	ns
C	MISO data hold time	100	150	ns
D	MISO rise/fall time, weak driver mode	3	20	ns
E	MISO data disable lag time	15	35	ns

**Table 16: SPI slave timing parameters A - E, 20 pF load capacitance**

Symbol	Parameter	Min	Max	Unit
A	MISO data valid time (CS)	26	85	ns
B	MISO data valid time (SCK), weak driver mode	30	85	ns
C	MISO data hold time	110	160	ns
D	MISO rise/fall time, weak driver mode	13	45	ns
E	MISO data disable lag time	15	35	ns

**Table 17: SPI slave timing parameters A - E, 60 pF load capacitance**

## 5.3 I2C

An I2C interface is available for communication with an external host CPU in I2C Fast-mode. Backwards compatibility with Standard-mode I2C bus operation is not supported. The interface can be operated only in slave mode with a maximum bit rate of 400 kbit/s. The interface can make use of clock stretching by holding the SCL line LOW to pause a transaction. In this case, the bit transfer rate is reduced. The maximum clock stretching time is 20 ms.

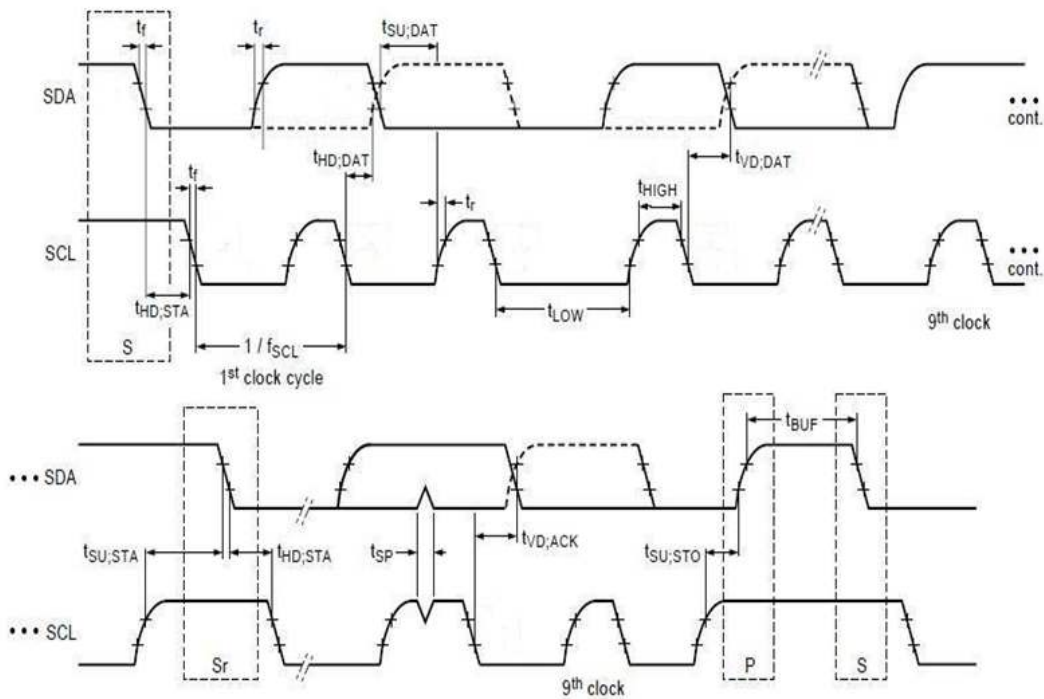
**Figure 4: NEO-M9N-00B I2C slave specification**

Symbol	Parameter	I2C Fast-mode		Unit
		Min	Max	
$f_{SCL}$	SCL clock frequency	0	400	kHz
$t_{HD,STA}$	Hold time (repeated) START condition	0.6	-	$\mu$ s
$t_{LOW}$	Low period of the SCL clock	1.3	-	$\mu$ s
$t_{HIGH}$	High period of the SCL clock	0.6	-	$\mu$ s
$t_{SU,STA}$	Setup time for a repeated START condition	0.6	-	$\mu$ s
$t_{HD,DAT}$	Data hold time	0 <sup>15</sup>	- <sup>16</sup>	$\mu$ s
$t_{SU,DAT}$	Data setup time	100 <sup>17</sup>	-	ns
$t_r$	Rise time of both SDA and SCL signals	-	300 (for C = 400pF)	ns
$t_f$	Fall time of both SDA and SCL signals	-	300 (for C = 400pF)	ns
$t_{SU,STO}$	Setup time for STOP condition	0.6	-	$\mu$ s
$t_{BUF}$	Bus-free time between a STOP and START condition	1.3	-	$\mu$ s
$t_{VD,DAT}$	Data valid time	-	0.9 <sup>16</sup>	$\mu$ s
$t_{VD,ACK}$	Data valid acknowledge time	-	0.9 <sup>16</sup>	$\mu$ s
$V_{nL}$	Noise margin at the low level	0.1 VCC	-	V
$V_{nH}$	Noise margin at the high level	0.2 VCC	-	V

**Table 18: NEO-M9N-00B I2C slave timings and specifications**

<sup>15</sup> External device must provide a hold time of at least one transition time (max 300 ns) for the SDA signal (with respect to the min  $V_{ih}$  of the SCL signal) to bridge the undefined region of the falling edge of SCL.

<sup>16</sup> The maximum  $t_{HD,DAT}$  must be less than the maximum  $t_{VD,DAT}$  or  $t_{VD,ACK}$  with a maximum of 0.9  $\mu$ s by a transition time. This maximum must only be met if the device does not stretch the LOW period ( $t_{LOW}$ ) of the SCL signal. If the clock stretches the SCL, the data must be valid by the set-up time before it releases the clock.

<sup>17</sup> When the I2C slave is stretching the clock, the  $t_{SU,DAT}$  of the first bit of the next byte is 62.5 ns.

 The I2C interface is only available with the UART default mode. If the SPI interface is selected by using D\_SEL = 0, the I2C interface is not available.

## 5.4 USB

The USB 2.0 FS (full speed, 12 Mbit/s) interface can be used for host communication. Due to the hardware implementation, it may not be possible to certify the USB interface. The V\_USB pin supplies the USB interface.

## 5.5 Default interface settings

Interface	Settings
UART	38400 baud, 8 bits, no parity bit, 1 stop bit. Output messages: NMEA <b>GGA</b> , <b>GLL</b> , <b>GSA</b> , <b>GSV</b> , <b>RMC</b> , <b>VTG</b> , <b>TXT</b> (no UBX). Input protocols: UBX, NMEA and RTCM 3.3.
USB	Output messages activated as in UART. Input protocols available as in UART.
I2C	Output messages activated as in UART. Input protocols available as in UART.
SPI	Output messages activated as in UART. Input protocols available as in UART.

**Table 19: Default interface settings**

 Refer to the applicable interface description [1] for information about further settings.

By default the NEO-M9N-00B outputs NMEA messages that include satellite data for all GNSS bands being received. This results in a higher-than-before NMEA load output for each navigation period. Make sure the UART baud rate being used is sufficient for the selected navigation rate and the number of GNSS signals being received.

## 6 Mechanical specification

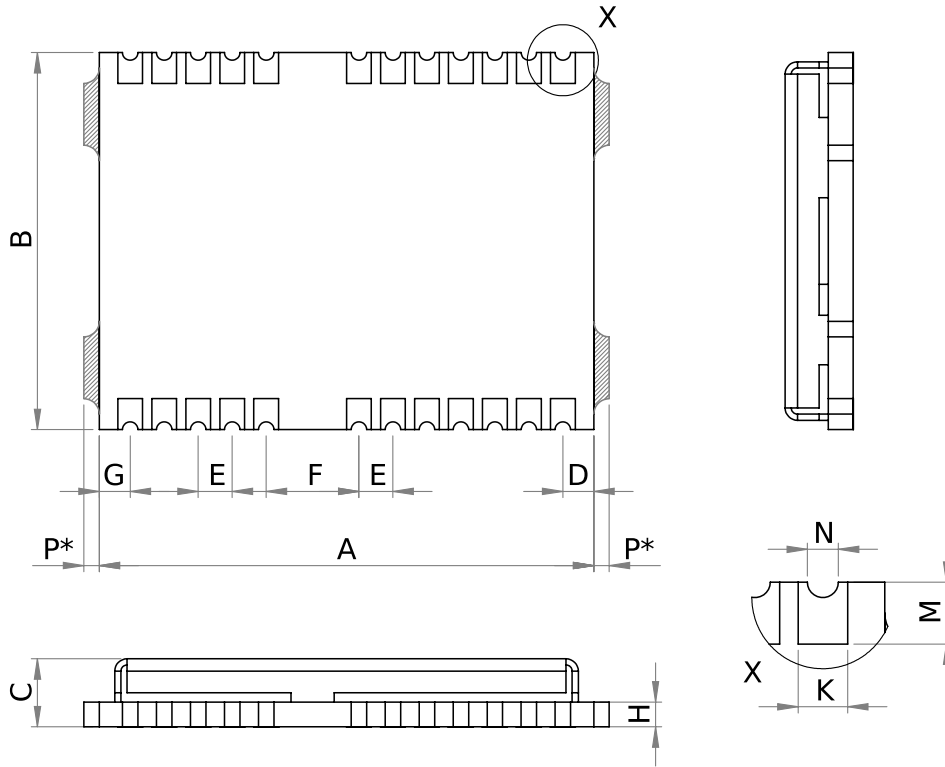



Figure 5: NEO-M9N-00B mechanical drawing

Symbol	Min (mm)	Typical (mm)	Max (mm)	
A	15.9	16.0	16.1	
B	12.1	12.2	12.3	
C	2.2	2.4	2.6	
D	0.9	1.0	1.1	
E	1.0	1.1	1.2	
F	2.9	3.0	3.1	
G	0.9	1.0	1.1	
H	-	0.82	-	
K	0.7	0.8	0.9	
M	0.8	0.9	1.0	
N	0.4	0.5	0.6	
P*	0.0	-	0.5	The de-paneling residual tabs may be on either side (not both).
Weight		1.6 g		

Table 20: NEO-M9N-00B mechanical dimensions



-  The mechanical picture of the de-paneling residual tabs (P\*) is an approximate representation, shape and position may vary.
-  Component keep-out area must consider that the de-paneling residual tabs can be on either side (not both).

## 7 Reliability tests and approvals

NEO-M9N-00B modules are based on AEC-Q100 qualified GNSS chips.

Tests for product family qualifications comply with ISO 16750 "Road vehicles – environmental conditions and testing for electrical and electronic equipment", and appropriate standards.

### 7.1 Approvals

NEO-M9N-00B complies with the essential requirements and other relevant provisions of the Radio Equipment Directive (RED) 2014/53/EU.

NEO-M9N-00B complies with the Directive 2011/65/EU (EU RoHS 2) and its amendment Directive (EU) 2015/863 (EU RoHS 3).

The Declaration of Conformity (DoC) is available on the [u-blox website](#).

## 8 Labeling and ordering information

This section provides information about product labeling and ordering. For information about moisture sensitivity level (MSL), product handling and soldering see the Integration manual [3].

### 8.1 Product labeling

The labeling of the NEO-M9N-00B modules provides product information and revision information. For more information contact u-blox sales.

### 8.2 Explanation of product codes

Three product code formats are used in the NEO-M9N-00B labels. The **Product name** used in documentation such as this data sheet identifies all u-blox products, independent of packaging and quality grade. The **Ordering code** includes options and quality, while the **Type number** includes the hardware and firmware versions.

Table 21 below details these three formats.

Format	Structure	Product code
Product name	PPP-TGV	NEO-M9N
Ordering code	PPP-TGV-NNQ	NEO-M9N-00B
Type number	PPP-TGV-NNQ-XX	NEO-M9N-00B-00

**Table 21: Product code formats**

The parts of the product code are explained in Table 22.

Code	Meaning	Example
PPP	Product family	NEO
TG	Platform	M9 = u-blox M9
V	Variant	N = Standard precision with SAW and LNA
NNQ	Option / Quality grade	NN: Option [00...99] Q: Grade, A = Automotive, B = Professional
XX	Product detail	Describes hardware and firmware versions

**Table 22: Part identification code**

### 8.3 Ordering codes

Ordering code	Product	Remark
NEO-M9N-00B	u-blox NEO-M9N module, professional grade	

**Table 23: Product ordering codes**



Product changes affecting form, fit or function are documented by u-blox. For a list of Product Change Notifications (PCNs) see our website at: <https://www.u-blox.com/en/product-resources>.

## Related documents

- [1] u-blox M9 SPG 4.04 Interface description, [UBX-21022436](#)  
u-blox M9 SPG 4.04 Interface description, UBX-21022437 (NDA required)
- [2] u-blox M9 SPG 4.04 Release notes, [UBX-20036165](#)
- [3] NEO-M9N Integration manual, [UBX-19014286](#)  
NEO-M9N Integration manual, UBX-19015769 (NDA required)



For regular updates to u-blox documentation and to receive product change notifications please register on our homepage <https://www.u-blox.com>.

## Revision history

Revision	Date	Name	Status / comments
R01	15-Aug-2019	jesk	Objective specification
R02	14-Nov-2019	jesk	Advance information
R03	24-Jan-2020	jesk	Advance information. Added out-band value for Prfin, renamed VDD_USB to V_USB.
R04	11-Sep-2020	jesk	Early production information. - Updated firmware to SPG 4.04. - Updated I_BCKP and indicative power consumption values. - Added supported voltage range for V_USB. - Added value for Ext_gain, External gain at RF_IN. - Added digital I/O pin DC current and pull up resistance values. - Clarified UART timing specifications. - Clarified use of USB interface.
R05	09-Jul-2021	jesk	Document status replaced by Product status in Document information. - Updated product name to include product option and quality grade - Updated GLONASS tracking sensitivity - Updated supported GNSS constellations: QZSS L1C/A support now listed - Updated QZSS augmentation service name - Updated Absolute maximum ratings: supply voltage ramp requirements
R06	14-Dec-22	rmak	Updated section Mechanical specification
R07	27-Mar-2023	rmak	Updated sections - Document information: updated IN/PCN reference - Absolute maximum ratings: updated maximum VCC_RF output current - DC electrical characteristics: updated TIMEPULSE drive strength - Indicative power requirements: current measured at 1 Hz navigation update rate, updated hardware backup mode current - SPI: updated timing specification - I2C: updated timing specification

## Contact

### u-blox AG

Address: Zürcherstrasse 68  
8800 Thalwil  
Switzerland

For further support and contact information, visit us at [www.u-blox.com/support](http://www.u-blox.com/support).