

Description

The PT7775 is a high-output, 32A Integrated Switching Regulator (ISR), housed in a 27-pin SIP package. The PT7775 is a low voltage version of the PT7779, a next generation “Sledge Hammer” ISR. These regulators include short circuit protection and require only 330 μ F of output capacitance.

The low-output voltage and 32A load capability makes the PT7775 an

ideal source for powering the industry’s latest high-speed, low-voltage μ Ps, ASICs, and DSPs from an existing 5V source. The output voltage is programmable from 0.8V to 3.1V, via a 5-bit input.

The PT7775 will operate with up to two PT7741 32A current boosters. A differential remote sense provides compensation for voltage drop between the ISR and load.

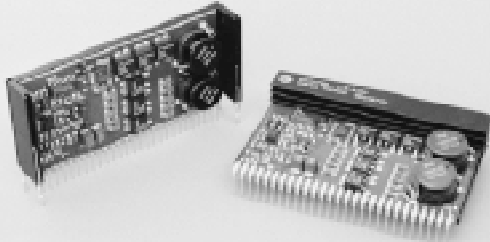

Standard Application

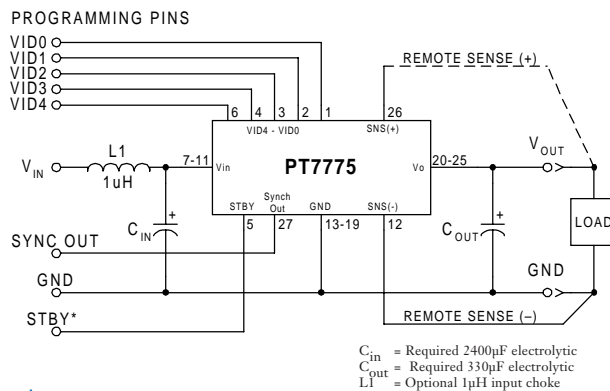

Pin-Out Information

Pin	Function	Pin	Function
1	VID0	14	GND
2	VID1	15	GND
3	VID2	16	GND
4	VID3	17	GND
5	STBY* - Stand-by	18	GND
6	VID4	19	GND
7	V _{in}	20	V _{out}
8	V _{in}	21	V _{out}
9	V _{in}	22	V _{out}
10	V _{in}	23	V _{out}
11	V _{in}	24	V _{out}
12	Remote Sense Gnd (5)	25	V _{out}
13	GND	26	Remote Sense V _{out}
		27	Sync Out

For STBY* pin; open = output enabled; ground = output disabled.

Specifications

Characteristics (T _a = 25°C unless noted)	Symbols	Conditions	PT7775			Units
			Min	Typ	Max	
Output Current	I _o	T _a = +60°C, 200 LFM, pkg N T _a = +25°C, natural convection	0.1 (1)	—	32	A
Input Voltage Range	V _{in}	0.1A ≤ I _o ≤ 32A	4.5	—	5.5	V
Output Voltage Tolerance	ΔV _o	V _{in} = +5V, I _o = 32A -40°C ≤ T _a ≤ +85°C	V _o -0.03	—	V _o +0.03	V
Line Regulation	Reg _{line}	4.5V ≤ V _{in} ≤ 5.5V, I _o = 32A	—	±10	—	mV
Load Regulation	Reg _{load}	V _{in} = +5V, 0.1 ≤ I _o ≤ 32A	—	±10	—	mV
V _o Ripple/Noise pk-pk	V _n	V _{in} = +5V, I _o = 32A	—	50	—	mV
Transient Response with C _{out} = 330 μ F	t _{rr}	I _o step between 16A and 32A	—	100	—	μ Sec
	V _{os}	V _o over/undershoot	—	200	—	mV
Efficiency	η	V _{in} = +5V, I _o = 20A, V _o = 3.3V	—	90	—	%
Switching Frequency	f _o	4.5V ≤ V _{in} ≤ 5.5V 0.1A ≤ I _o ≤ 32A	300	350	400	kHz
Absolute Maximum Operating Temperature Range	T _a	Over V _{in} Range	-40	—	+85 (2)	°C
Storage Temperature	T _s	—	-40	—	+125	°C
Mechanical Vibration		Per Mil-STD-883D, Method 2007.2, 20-20,000Hz, Soldered in a PC board	—	10/15	—	G's
Weight	—	Vertical/Horizontal	—	53/66	—	grams

Notes: (1) ISR will operate down to no load with reduced specifications.

(2) See SOA curves or consult the factory for the appropriate derating.

(3) If the remote sense ground is not used, pin 12 must be connected to pin 13 for optimum output voltage accuracy.

External Capacitors: The PT7775 requires a minimum output capacitance of 330 μ F (ESR ≤ 0.1 Ω) for proper operation. The PT7775 also requires an input capacitance of 2400 μ F, which must be rated for a minimum of 2.0Arms ripple current. For transient or dynamic load applications, additional capacitance may be required. For further information, see the accompanying capacitor application note for this product.

Input Filter: An input filter choke is optional for most applications. The input inductor must be sized to handle 32ADC with a typical value of 1 μ H.

PT7775—5V

32 Amp 0.8V to 3.1V Programmable Integrated Switching Regulator

Features

- +5V input
- 32A Output (64A with PT7741)
- 5-bit Programmable: 0.8V to 3.1V
- 90% Efficiency
- Short Circuit Protection
- Differential Remote Sense
- 27-pin SIP Package
- Compatible with PT7741 “Current Booster”

Programming Information

VID3	VID2	VID1	VID0	VID4=1 Vout	VID4=0 Vout
1	1	1	1	1.6V	0.80V
1	1	1	0	1.7V	0.85V
1	1	0	1	1.8V	0.90V
1	1	0	0	1.9V	0.95V
1	0	1	1	2.0V	1.00V
1	0	1	0	2.1V	1.05V
1	0	0	1	2.2V	1.10V
1	0	0	0	2.3V	1.15V
0	1	1	1	2.4V	1.20V
0	1	1	0	2.5V	1.25V
0	1	0	1	2.6V	1.30V
0	1	0	0	2.7V	1.35V
0	0	1	1	2.8V	1.40V
0	0	1	0	2.9V	1.45V
0	0	0	1	3.0V	1.50V
0	0	0	0	3.1V	1.55V

Logic 0 = Pin 12 potential (remote sense gnd)
 Logic 1 = Open circuit (no pull-up resistors)
 VID3 and VID4 may not be changed while the unit is operating.

Ordering Information

PT7775□ = 0.8 to 3.1 Volts

For dimensions and PC board layout, see Package Style 1020 and 1030

PT Series Suffix (PT1234X)

Case/Pin Configuration	
Vertical Through-Hole	N
Horizontal Through-Hole	A
Horizontal Surface Mount	C

TYPICAL CHARACTERISTICS

Performance Characteristics, $V_{IN}=5.0V$ (See Note A)

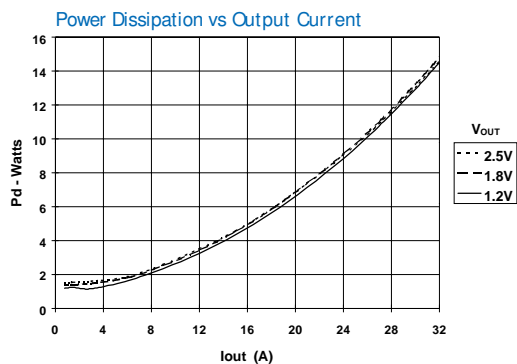
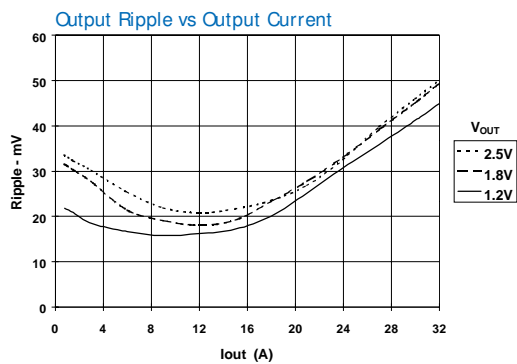
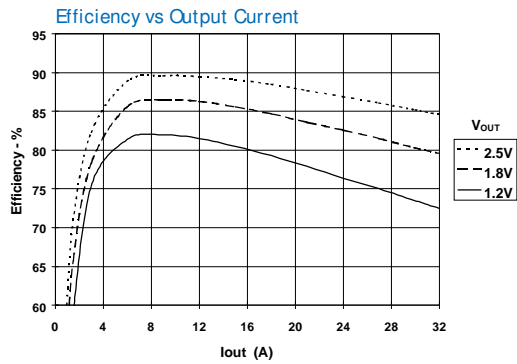

Safe Operating Area, $V_{IN}=5.0V$ (See Note B)

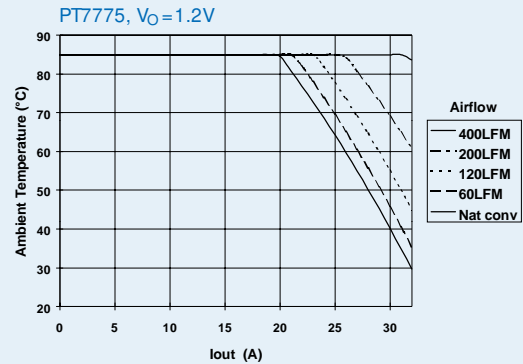
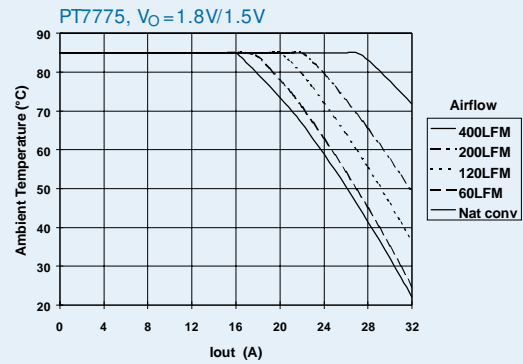

Note A: Characteristic data has been developed from actual products tested at 25°C. This data is considered typical for the regulator.

Note B: Safe Operating Area curves represent conditions at which internal components are at or below manufacturer's maximum operating temperatures.

PT7775, PT7778, PT7779

Capacitor Recommendations for the PT7775/8/9 Regulators and PT7740/1 Current Boosters

Input Capacitors

The recommended input capacitance is determined by 2.0 ampere minimum ripple current rating and 1500 μ F minimum capacitance. Capacitors listed below must be rated for a minimum of 2x the input voltage with +5V operation. Ripple current and $\leq 100\text{m}\Omega$ Equivalent Series Resistance (ESR) values are the major considerations along with temperature when selecting the proper capacitor.

Output Capacitors

The minimum required output capacitance is 330 μ F with a maximum ESR less than or equal to 100m Ω . Failure to observe this requirement may lead to regulator instability or oscillation. Electrolytic capacitors have poor ripple performance at frequencies greater than 400kHz, but excellent low frequency transient response. Above the ripple frequency ceramic decoupling capacitors are necessary to improve the transient response and reduce any microprocessor high frequency noise components apparent during higher current excursions. Preferred low ESR type capacitor part numbers are identified in the Table 1 below.

Tantalum Characteristics

Tantalum capacitors with a minimum 10V rating are recommended on the output bus, but only the AVX TPS Series, Sprague 594/595 Series, or Kemet T495/T510 Series. The AVX TPS Series, Sprague Series or Kemet Series capacitors are specified over other types due to their higher surge current, excellent power dissipation and ripple current ratings. As an example, the TAJ Series by AVX is not recommended. This series exhibits considerably higher ESR, reduced power dissipation and lower ripple current capability. The TAJ Series is a less reliable compared to the TPS series when determining power dissipation capability.

Capacitor Table

Table 1 identifies the characteristics of capacitors from a number of vendors with acceptable ESR and ripple current (rms) ratings. The suggested minimum quantities per regulator for both the input and output buses are identified.

This is not an extensive capacitor list. The table below is a selection guide for input and output capacitors. Other capacitor vendors are available with comparable RMS ripple current rating and ESR (Equivalent Series Resistance at 100kHz). These critical parameters are necessary to insure both optimum regulator performance and long capacitor life.

Table 1 Capacitors Characteristic Data

Capacitor Vendor/ Series	Capacitor Characteristics					Quantity		Vendor Number
	Working Voltage	Value(μ F)	(ESR) Equivalent Series Resistance	105°C Maximum Ripple Current(Irms)	Physical Size(mm)	Input Bus	Output Bus	
Panasonic FC Surface Mtg	16V	3300	0.028 Ω	2490mA	18x21.5	1	1	EEVFC1C333N EEVFC1V331LQ
	35V	330	0.065 Ω	1205mA	12.5x16.5			
FA Radial	10V	680	0.090 Ω	755mA	10x12.5	2	1	EEUFA1A681 EEUFA1C122S
	16V	1200	0.038 Ω	1690mA	16x15			
United Chemi -Con LFVSeries	25V	330	0.084 Ω	825mA	10x16	2	1	LXV25VB331M10X16LL LXV16VB222M16X20LL LXV16VB471M10X16LL
	16V	2200	0.038 Ω	1630mA	16x20			
	16V	470	0.084 Ω	825mA	10x16			
Nichicon PL Series PM Series	10V	680	0.085 Ω	795mA	10x15	2	1	UPL1A681MPH6 UPL1A272MHH6 UPL1E331MPH6
	10V	2700	0.035 Ω	1740mA	16x20			
	25V	330	0.095 Ω	750mA	10x15			
Oscon SS SV	10V	330	0.025 $\Omega/7=0.006\Omega$	>9800mA	10x10.5	7	N/R (Note)	10SS330M 10SV330M(Sufvace Mtg)
	10V	330	0.020 $\Omega/7=0.005\Omega$	>9800mA	10.3x12.6			
AVX Tanatalum TPS- Series	10V	330	0.100/7=15 Ω	3500mA	7.3L x 4.3W x 4.1H	7	1	TPSV337M010R0100 TPSV337M010R0060
	10V	330	0.060/7 Ω	1826mA	7.3L x 5.7W x 4.0H			
Sprague Tantalum 595D/594D	10V	330	0.045W/7=0.011 Ω	>4500mA	7.3L x 5.7W x 4.0H	7	1	594D337X0010R2T Surface Mount 595D687X0010R2T
	10V	680	0.090 $\Omega/4$	>1660mA	7.3L x 5.7W x 4.0H			
Kemet Tantalum T510/T495 Series	10V	330	0.035 $\Omega/5=0.007\Omega$	2000mA	4.3W x 7.3L x 4.0H	7	1	T510X337M010AS T495X227M010AS Surface Mount
	10V	220	0.070 $\Omega/2=0.035\Omega$	>2000mA	4.3W x 7.3L x 3.1H			
Sanyo Poscap TPB	10V	220	0.040 Ω	3000mA	7.2L x 4.3W x 3.1H	2	2	10TPB220M Surface Mount

Note: (N/R) is not recommended for this application, extremely low Equivalent Series Resistance (ESR)

IMPORTANT NOTICE

Texas Instruments and its subsidiaries (TI) reserve the right to make changes to their products or to discontinue any product or service without notice, and advise customers to obtain the latest version of relevant information to verify, before placing orders, that information being relied on is current and complete. All products are sold subject to the terms and conditions of sale supplied at the time of order acknowledgment, including those pertaining to warranty, patent infringement, and limitation of liability.

TI warrants performance of its semiconductor products to the specifications applicable at the time of sale in accordance with TI's standard warranty. Testing and other quality control techniques are utilized to the extent TI deems necessary to support this warranty. Specific testing of all parameters of each device is not necessarily performed, except those mandated by government requirements.

Customers are responsible for their applications using TI components.

In order to minimize risks associated with the customer's applications, adequate design and operating safeguards must be provided by the customer to minimize inherent or procedural hazards.

TI assumes no liability for applications assistance or customer product design. TI does not warrant or represent that any license, either express or implied, is granted under any patent right, copyright, mask work right, or other intellectual property right of TI covering or relating to any combination, machine, or process in which such semiconductor products or services might be or are used. TI's publication of information regarding any third party's products or services does not constitute TI's approval, warranty or endorsement thereof.