

## 30A Austin MegaLynx™: Non-Isolated DC-DC Power Modules

2.7Vdc – 4.0Vdc input; 0.8Vdc to 2.0Vdc output; 30A Output Current



### RoHS Compliant

### Features

- Compliant to RoHS EU Directive 2011/65/EU (-Z versions)
- Compliant to RoHS EU Directive 2011/65/EU under exemption 7b (Lead solder exemption). Exemption 7b will expire after June 1, 2016 at which time this product will no longer be RoHS compliant (non-Z versions)
- Delivers up to 30A of output current
- High efficiency – 92% @ 1.8V full load ( $V_{IN}=3.3Vdc$ )
- Input voltage range from 2.7V to 4.0Vdc
- Output voltage programmable from 0.8 to 2.0Vdc
- Small size and low profile:
  - 33.0 mm x 9.1 mm x 13.5 mm
  - (1.30 in. x 0.36 in. x 0.53 in.)
- Monotonic start-up into pre-biased output
- Output voltage sequencing (EZ-SEQUENCE™)
- Remote On/Off
- Remote Sense
- Over current and Over temperature protection
- Parallel operation with active current sharing
- Wide operating temperature range (-40°C to 85°C)
- UL\* 60950 Recognized, CSA† C22.2 No. 60950-00 Certified, and VDE‡ 0805 (EN60950-1 3<sup>rd</sup> edition) Licensed
- ISO\*\* 9001 and ISO 14001 certified manufacturing facilities

### Applications

- Distributed power architectures
- Intermediate bus voltage applications
- Telecommunications equipment
- Servers and storage applications
- Networking equipment

### Description

The Austin MegaLynx ATM series SMT power modules are non-isolated DC-DC converters in an industry standard package that can deliver up to 30A of output current with a full load efficiency of 92% at 1.8Vdc output voltage ( $V_{IN} = 3.3Vdc$ ). These modules operate off an input voltage from 2.7 to 4.0Vdc and provide an output voltage that is programmable from 0.8 to 2.0Vdc. They have a sequencing feature that enables designers to implement various types of output voltage sequencing when powering multiple modules on the board. Additional features include remote On/Off, adjustable output voltage, remote sense, over current, over temperature protection and active current sharing between modules.

\* UL is a registered trademark of Underwriters Laboratories, Inc.

† CSA is a registered trademark of Canadian Standards Association.

‡ VDE is a trademark of Verband Deutscher Elektrotechniker e.V.

\*\* ISO is a registered trademark of the International Organization of Standards



## 30A Austin MegaLynx™: Non-Isolated DC-DC Power Modules

2.7Vdc – 4.0Vdc input; 0.8Vdc to 2.0Vdc output; 30A Output Current

### Absolute Maximum Ratings

Stresses in excess of the absolute maximum ratings can cause permanent damage to the device. These are absolute stress ratings only, functional operation of the device is not implied at these or any other conditions in excess of those given in the operations sections of the data sheet. Exposure to absolute maximum ratings for extended periods can adversely affect the device reliability.

Parameter	Device	Symbol	Min	Max	Unit
Input Voltage Continuous	All	$V_{IN}$	-0.3	4.0	Vdc
Sequencing pin voltage	All	$V_{SEQ}$	-0.3	4.0	Vdc
Operating Ambient Temperature (see Thermal Considerations section)	All	$T_A$	-40	85	°C
Storage Temperature	All	$T_{stg}$	-55	125	°C

### Electrical Specifications

Unless otherwise indicated, specifications apply over all operating input voltage, resistive load, and temperature conditions.

Parameter	Device	Symbol	Min	Typ	Max	Unit
Operating Input Voltage	All	$V_{IN}$	2.7	3.3	4.0	Vdc
Maximum Input Current ( $V_{IN}=V_{IN,min}$ , $V_O=V_{O,set}$ , $I_O=I_{O,max}$ )	All	$I_{IN,max}$			20	Adc
Inrush Transient	All	$I^2 t$			1	A <sup>2</sup> s
Input Reflected Ripple Current, peak-to-peak (5Hz to 20MHz, 1μH source impedance; $V_{IN}=2.7V$ to 4.0V, $I_O=I_{O,max}$ ; See Figure 1)	All			100		mAp-p
Input Ripple Rejection (120Hz)	All			50		dB

## 30A Austin MegaLynx™: Non-Isolated DC-DC Power Modules

2.7Vdc – 4.0Vdc input; 0.8Vdc to 2.0Vdc output; 30A Output Current

### Electrical Specifications (continued)

Parameter	Device	Symbol	Min	Typ	Max	Unit
Output Voltage Set-point ( $V_{IN}=V_{IN,nom}$ , $I_o=I_{o,nom}$ , $T_{ref}=25^{\circ}C$ )	All	$V_{o,set}$	-1.5	—	+1.5	% $V_{o,set}$
Output Voltage (Over all operating input voltage, resistive load, and temperature conditions until end of life)	All	$V_{o,set}$	-3.0	—	+3.0	% $V_{o,set}$
Adjustment Range Selected by an external resistor	All		0.8		2.0	Vdc
Output Regulation Line ( $V_{IN}=V_{IN,min}$ to $V_{IN,max}$ ) Load ( $I_o=I_{o,min}$ to $I_{o,max}$ ) Temperature ( $T_{ref}=T_{A,min}$ to $T_{A,max}$ )	All All All		— — —	— — 0.5	0.1 0.4 1	% $V_{o,set}$ % $V_{o,set}$ % $V_{o,set}$
Output Ripple and Noise on nominal output ( $V_{IN}=V_{IN,nom}$ and $I_o=I_{o,min}$ to $I_{o,max}$ ) $C_{OUT} = 0.1\mu F // 10\mu F$ ceramic capacitors Peak-to-Peak (5Hz to 20MHz bandwidth)	$V_o \leq 2.0V$		—		50	mV <sub>pk-pk</sub>
External Capacitance <sup>1</sup> ESR $\geq 1\text{ m}\Omega$ ESR $\geq 10\text{ m}\Omega$	All All	$C_{o,max}$ $C_{o,max}$	0 0	— —	2,000 10,000	$\mu F$ $\mu F$
Output Current	$V_o \leq 3.63V$	$I_o$	0		30	A <sub>dc</sub>
Output Current Limit Inception (Hiccup Mode)	All	$I_{o,lim}$	104	140	160	% $I_{o,max}$
Output Short-Circuit Current ( $V_o \leq 250mV$ ) (Hiccup Mode)	All	$I_{o,s/c}$	—	3.5	—	A <sub>dc</sub>
Efficiency $V_{IN}=V_{IN,nom}$ , $T_A=25^{\circ}C$ $I_o=I_{o,max}$ , $V_o=V_{o,set}$	$V_{o,set} = 0.8\text{dc}$ $V_{o,set} = 1.25\text{Vdc}$ $V_{o,set} = 1.8\text{Vdc}$	$\eta$ $\eta$ $\eta$		83.5 87.9 91.6		% % %
Switching Frequency, Fixed	All	$f_{sw}$	—	270	—	kHz
Dynamic Load Response ( $dI_o/dt=5A/\mu s$ ; $V_{IN}=V_{IN,nom}$ ; $T_A=25^{\circ}C$ ) Load Change from $I_o= 50\%$ to $100\%$ of $I_{o,max}$ ; No external output capacitors Peak Deviation Settling Time ( $V_o < 10\%$ peak deviation)	All All	$V_{pk}$ $t_s$	— —	380 50	— —	mV $\mu s$
( $dI_o/dt=5A/\mu s$ ; $V_{IN}=V_{IN,nom}$ ; $T_A=25^{\circ}C$ ) Load Change from $I_o= 100\%$ to $50\%$ of $I_{o,max}$ ; No external output capacitors Peak Deviation Settling Time ( $V_o < 10\%$ peak deviation)	All All	$V_{pk}$ $t_s$	— —	380 50	— —	mV $\mu s$

<sup>1</sup> Note that maximum external capacitance may be lower when sequencing is employed. Please check with your GE Technical representative.

## 30A Austin MegaLynx™: Non-Isolated DC-DC Power Modules

2.7Vdc – 4.0Vdc input; 0.8Vdc to 2.0Vdc output; 30A Output Current

### Electrical Specifications (continued)

Parameter	Device	Symbol	Min	Typ	Max	Unit
Dynamic Load Response ( $di_o/dt=5A/\mu s$ ; $V_{IN}=V_{IN, nom}$ ; $T_A=25^\circ C$ ) Load Change from $I_o= 50\%$ to $100\%$ of $I_{o,max}$ ; $2 \times 150 \mu F$ polymer capacitor						
Peak Deviation	All	$V_{pk}$	—	350	—	mV
Settling Time ( $V_o < 10\%$ peak deviation)	All	$t_s$	—	40	—	$\mu s$
Dynamic Load Response ( $di_o/dt=5A/\mu s$ ; $V_{IN}=V_{IN, nom}$ ; $T_A=25^\circ C$ ) Load Change from $I_o= 100\%$ to $50\%$ of $I_{o,max}$ ; $2 \times 150 \mu F$ polymer capacitor						
Peak Deviation	All	$V_{pk}$	—	250	—	mV
Settling Time ( $V_o < 10\%$ peak deviation)	All	$t_s$	—	60	—	$\mu s$

### General Specifications

Parameter	Min	Typ	Max	Unit
Calculated MTBF ( $V_o= 1.2Vdc$ , $I_o= 0.8I_{o, max}$ , $T_A=40^\circ C$ ) Per Telecordia Method		3,443,380		Hours
Weight	—	6.2 (0.22)	—	g (oz.)

## 30A Austin MegaLynx™: Non-Isolated DC-DC Power Modules

2.7Vdc – 4.0Vdc input; 0.8Vdc to 2.0Vdc output; 30A Output Current

### Feature Specifications

Unless otherwise indicated, specifications apply over all operating input voltage, resistive load, and temperature conditions. See Feature Descriptions for additional information.

Parameter	Device	Symbol	Min	Typ	Max	Unit
On/Off Signal Interface ( $V_{IN}=V_{IN, min}$ to $V_{IN, max}$ ; open collector or equivalent, Signal referenced to GND)						
Logic High (Module OFF)						
Input High Current	All	$I_{IH}$	0.5	—	3.3	mA
Input High Voltage	All	$V_{IH}$	2.5	—	$V_{IN, max}$	V
Logic Low (Module ON)						
Input Low Current	All	$I_{IL}$	—	—	200	$\mu$ A
Input Low Voltage	All	$V_{IL}$	-0.3	—	1.2	V
Turn-On Delay and Rise Times ( $V_{IN}=V_{IN, nom}$ , $I_o=I_{o, max}$ , $V_o$ to within $\pm 1\%$ of steady state)						
Case 1: On/Off input is enabled and then input power is applied (delay from instant at which $V_{IN} = V_{IN, min}$ until $V_o = 10\%$ of $V_{o, set}$ )	All	$T_{delay}$	3.8	4.7	6	msec
Case 2: Input power is applied for at least one second and then the On/Off input is enabled (delay from instant at which $V_{on/Off}$ is enabled until $V_o = 10\%$ of $V_{o, set}$ )	All	$T_{delay}$	3.8	4.7	6	msec
Output voltage Rise time (time for $V_o$ to rise from 10% of $V_{o, set}$ to 90% of $V_{o, set}$ )	All	$T_{rise}$	2.5	3	3.8	msec
Output voltage overshoot $I_o = I_{o, max}$ ; $V_{IN, min} - V_{IN, max}$ , $T_A = 25^\circ\text{C}$					3.0	% $V_{o, set}$
Remote Sense Range	All		—	—	0.5	V
Over temperature Protection (See Thermal Consideration section)	All	$T_{ref}$	—	125	—	$^\circ\text{C}$
Sequencing Slew rate capability ( $V_{IN, min}$ to $V_{IN, max}$ ; $I_{o, min}$ to $I_{o, max}$ $V_{SEQ} < V_o$ )	All	$dV_{SEQ}/dt$		—	2	V/msec
Sequencing Delay time (Delay from $V_{IN, min}$ to application of voltage on SEQ pin)	All	$T_{SEQ-delay}$	10			msec
Tracking Accuracy						
Power-up (2V/ms)	All	$V_{SEQ} - V_o$		100	200	mV
Power-down (1V/ms)		$V_{SEQ} - V_o$		200	400	mV
Input Undervoltage Lockout						
Turn-on Threshold	All				2.2	Vdc
Turn-off Threshold	All			1.7		Vdc
Forced Load Share Accuracy	-P		—	10		% $I_o$
Number of units in Parallel	-P				5	

# 30A Austin MegaLynx™: Non-Isolated DC-DC Power Modules

2.7Vdc – 4.0Vdc input; 0.8Vdc to 2.0Vdc output; 30A Output Current

## Characteristic Curves

The following figures provide typical characteristics for the ATM030A0X3-SR & -SRH (0.8V, 30A) at 25°C.

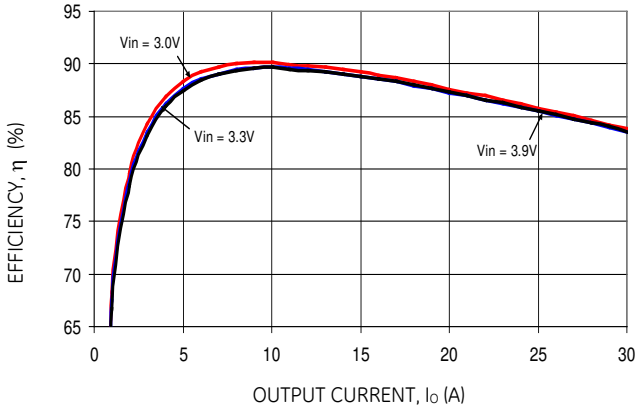

Figure 1. Converter Efficiency versus Output Current.

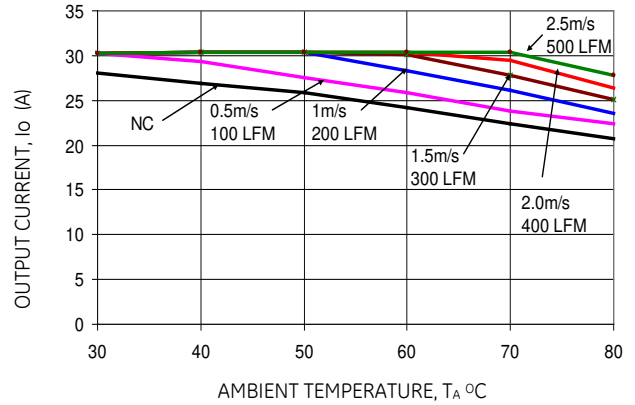

Figure 4. Derating Output Current versus Ambient Temperature and Airflow (ATM030A0X3-SR).

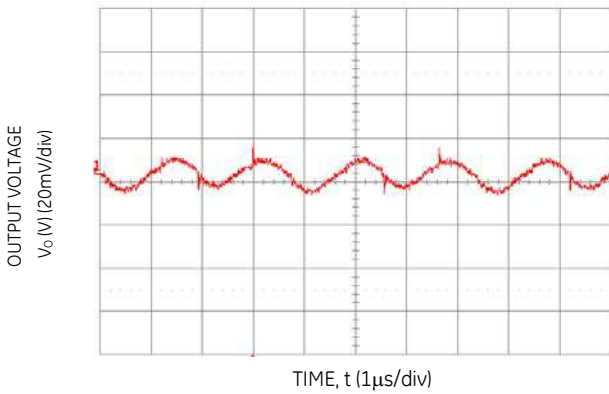

Figure 2. Typical output ripple and noise ( $V_{IN} = V_{IN,NOM}$ ,  $I_o = I_{o,max}$ ).

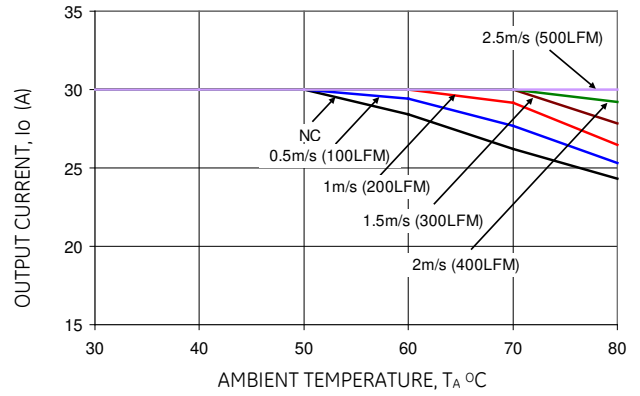

Figure 5. Derating Output Current versus Ambient Temperature and Airflow (ATM030A0X3-SRH).

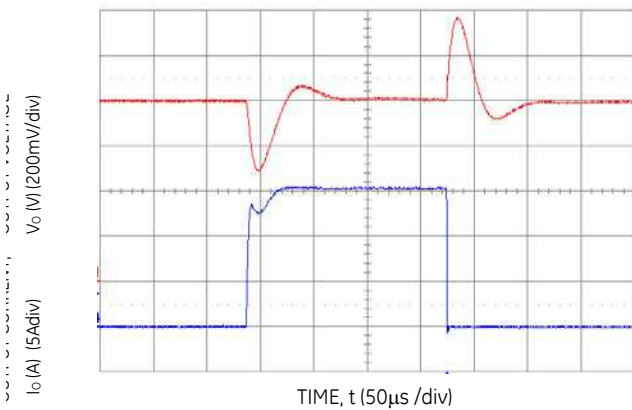

Figure 3. Transient Response to Dynamic Load Change from 0% to 50% to 0% of full load.

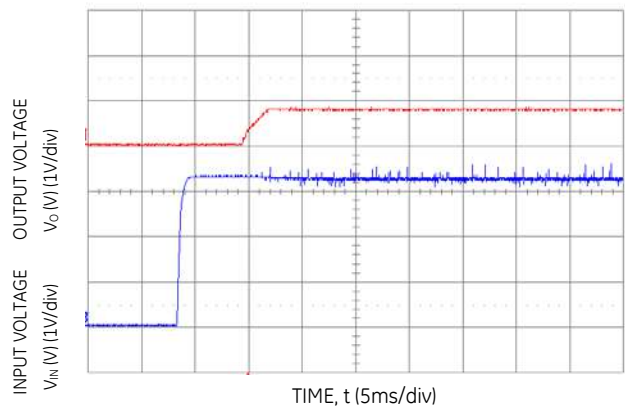

Figure 6. Typical Start-up Using Input Voltage ( $V_{IN} = V_{IN,NOM}$ ,  $I_o = I_{o,max}$ ).

# 30A Austin MegaLynx™: Non-Isolated DC-DC Power Modules

2.7Vdc – 4.0Vdc input; 0.8Vdc to 2.0Vdc output; 30A Output Current

## Characteristic Curves

The following figures provide typical characteristics for the ATM030A0X3-SR and -SRH (1.25V, 30A) at 25°C.

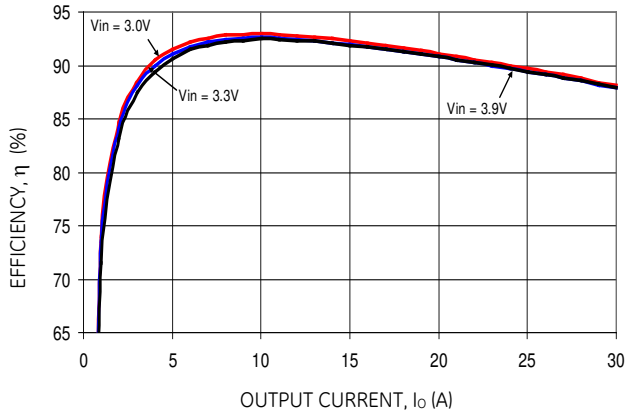

Figure 7. Converter Efficiency versus Output Current.

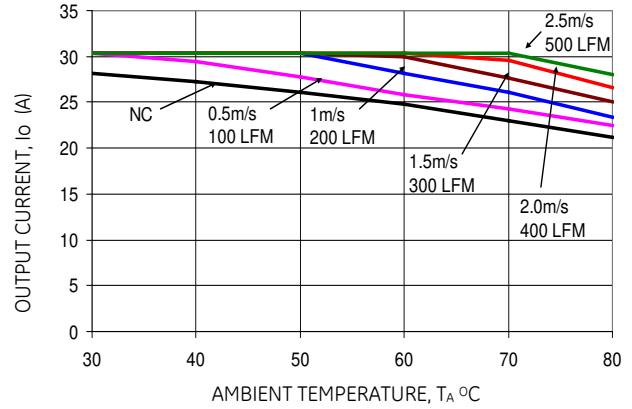

Figure 10. Derating Output Current versus Ambient Temperature and Airflow (ATM030A0X3-SR).

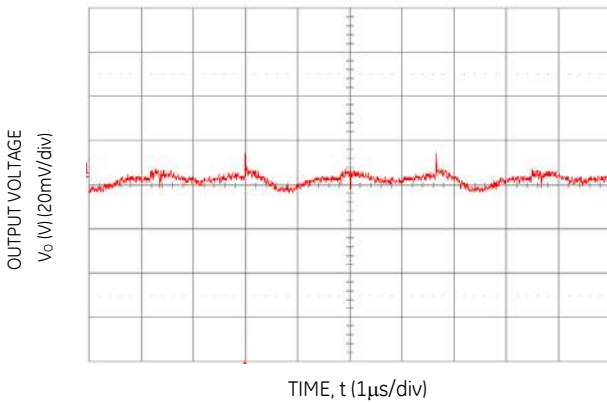

Figure 8. Typical output ripple and noise ( $V_{IN} = V_{IN,NOM}$ ,  $I_o = I_{o,max}$ ).

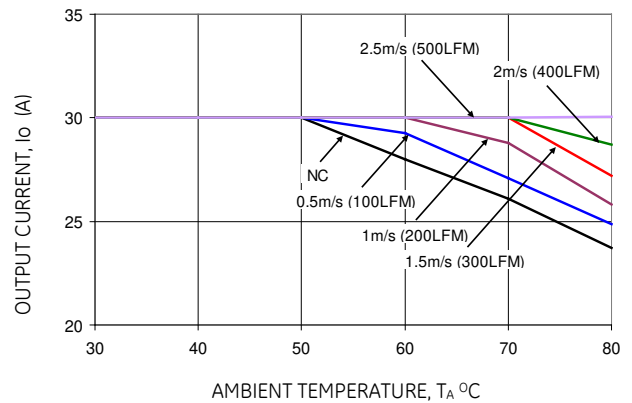

Figure 11. Derating Output Current versus Ambient Temperature and Airflow (ATM030A0X3-SRH).

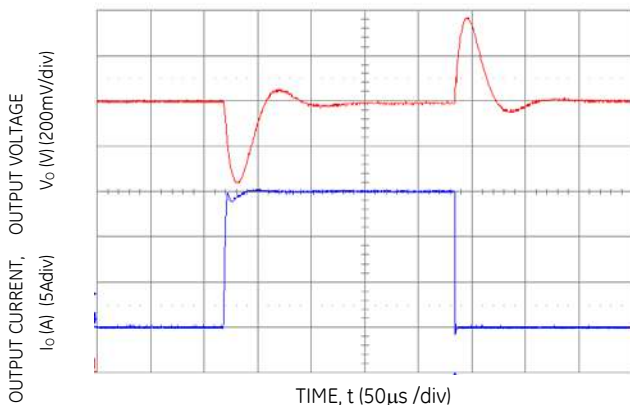

Figure 9. Transient Response to Dynamic Load Change from 0% to 50% to 0% of full load.

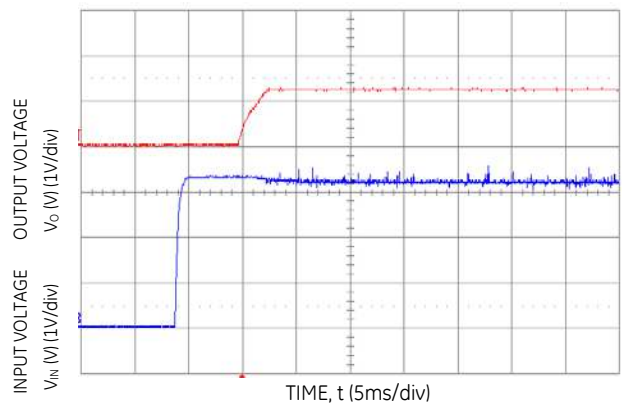

Figure 12. Typical Start-up Using Input Voltage ( $V_{IN} = V_{IN,NOM}$ ,  $I_o = I_{o,max}$ ).

# 30A Austin MegaLynx™: Non-Isolated DC-DC Power Modules

2.7Vdc – 4.0Vdc input; 0.8Vdc to 2.0Vdc output; 30A Output Current

## Characteristic Curves

The following figures provide typical characteristics for the ATM030A0X3-SR and –SRH (1.8V, 30A) at 25°C.

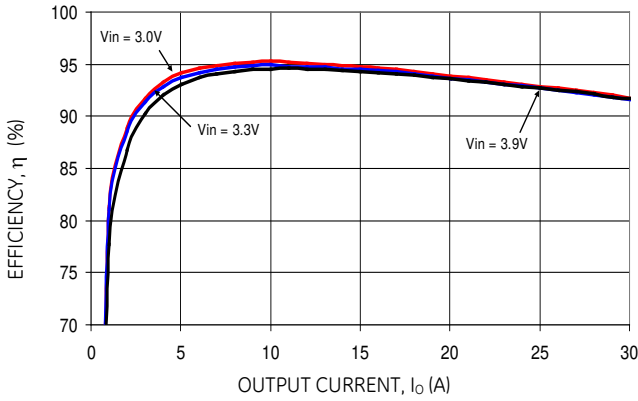

Figure 13. Converter Efficiency versus Output Current.

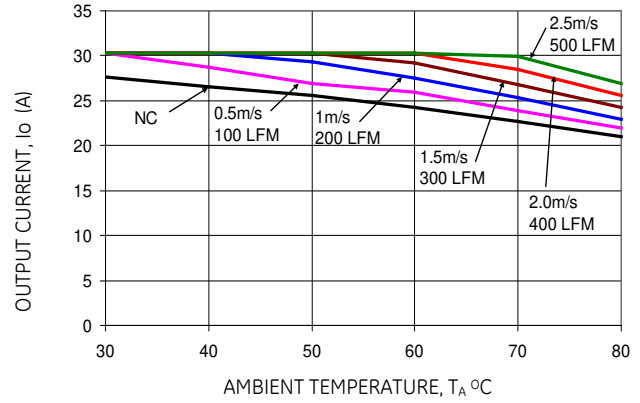

Figure 16. Output Current Derating versus Ambient Temperature and Airflow (ATM030A0X3-SR).

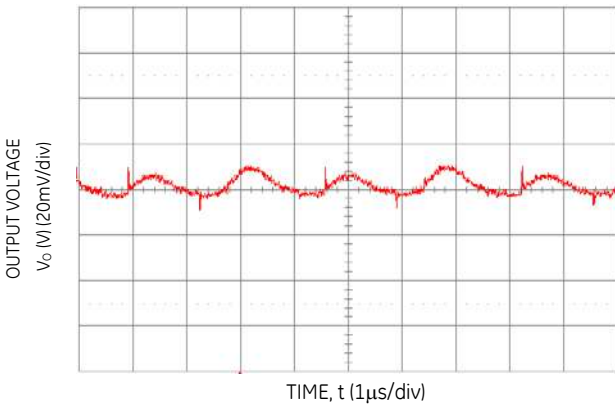

Figure 14. Typical output ripple and noise ( $V_{IN} = V_{IN,NOM}$ ,  $I_o = I_{o,max}$ ).

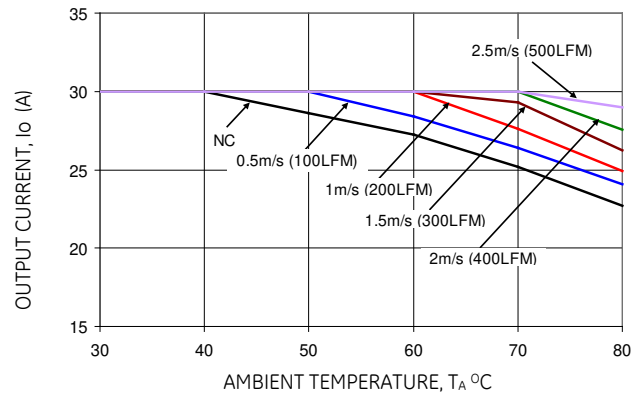

Figure 17. Output Current Derating versus Ambient Temperature and Airflow (ATM030A0X3-SRH).

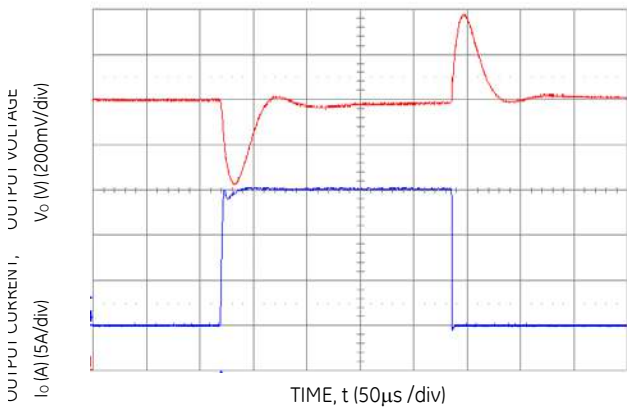

Figure 15. Transient Response to Dynamic Load Change from 0% to 50% to 0% of full load.

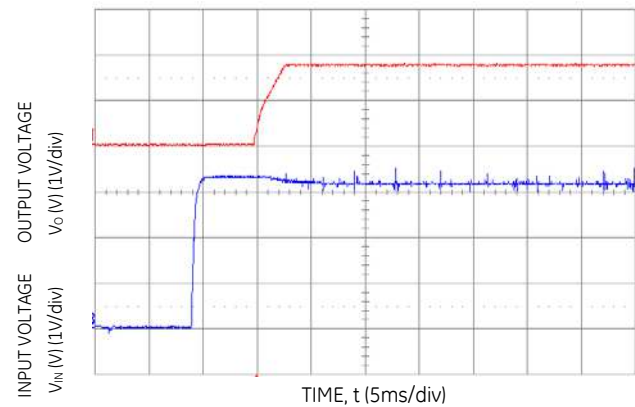

Figure 18. Typical Start-up Using Input Voltage ( $V_{IN} = V_{IN,NOM}$ ,  $I_o = I_{o,max}$ ).



# 30A Austin MegaLynx™: Non-Isolated DC-DC Power Modules

2.7Vdc – 4.0Vdc input; 0.8Vdc to 2.0Vdc output; 30A Output Current

## Characteristic Curves

The following figures provide typical characteristics for the ATM030A0X3-SR and -SRH (2.0V, 30A) at 25°C.

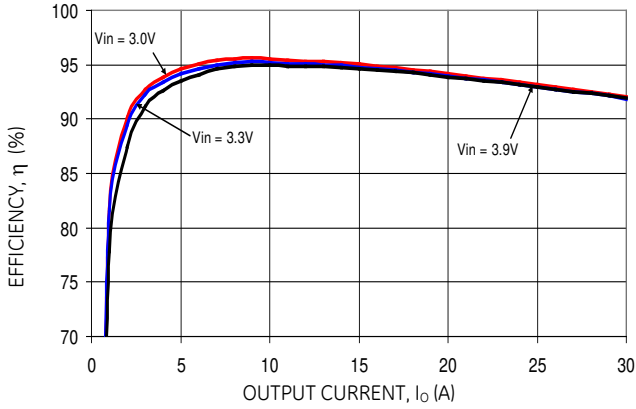

Figure 19. Converter Efficiency versus Output Current.

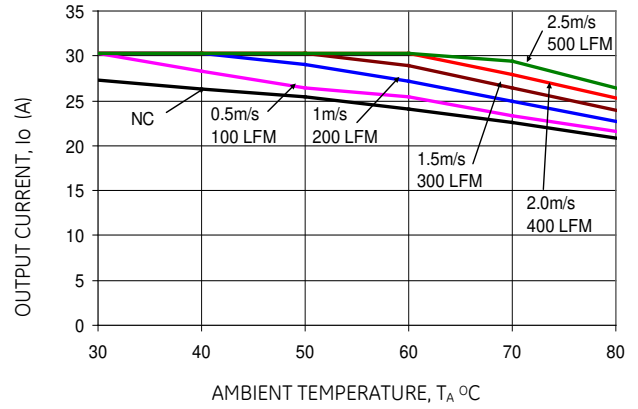

Figure 22. Output Current Derating versus Ambient Temperature and Airflow (ATM030A0X3-SR).

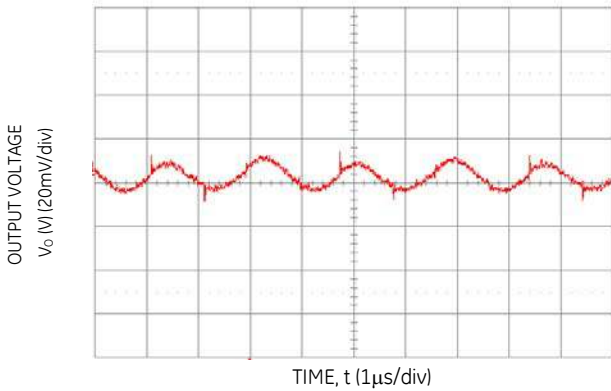

Figure 20. Typical output ripple and noise ( $V_{IN} = V_{IN,NOM}$ ,  $I_o = I_{o,max}$ ).

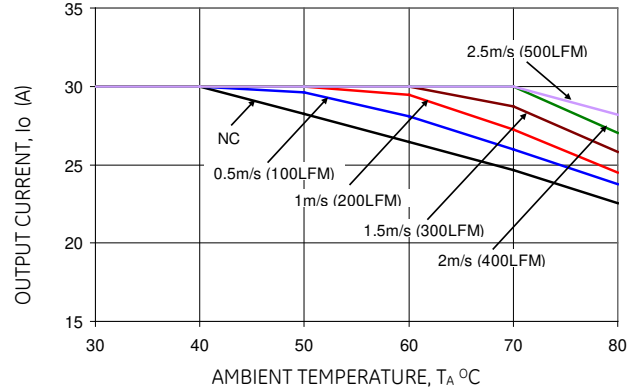

Figure 23. Output Current Derating versus Ambient Temperature and Airflow (ATM030A0X3-SRH).

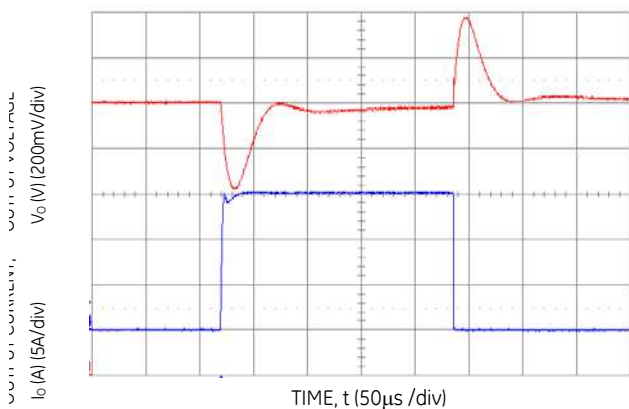

Figure 21. Transient Response to Dynamic Load Change from 0% to 50% to 0% of full load.

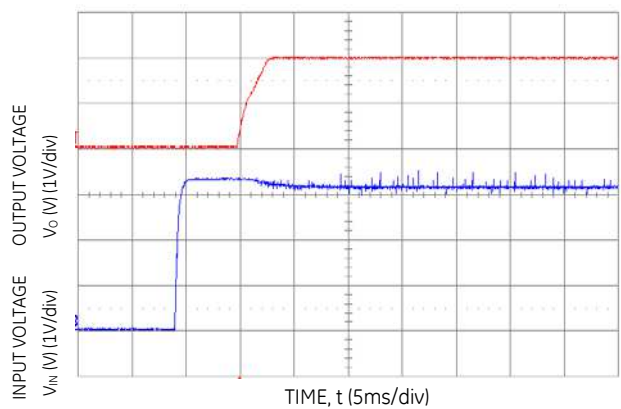
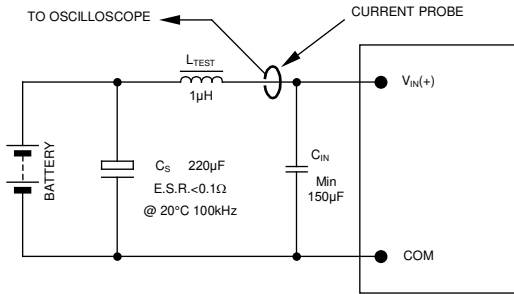

Figure 24. Typical Start-up Using Input Voltage ( $V_{IN} = V_{IN,NOM}$ ,  $I_o = I_{o,max}$ ).

# 30A Austin MegaLynx™: Non-Isolated DC-DC Power Modules

2.7Vdc – 4.0Vdc input; 0.8Vdc to 2.0Vdc output; 30A Output Current

## Test Configurations



NOTE: Measure input reflected ripple current with a simulated source inductance ( $L_{TEST}$ ) of 1µH. Capacitor  $C_S$  offsets possible battery impedance. Measure current as shown above.

Figure 25. Input Reflected Ripple Current Test Setup.

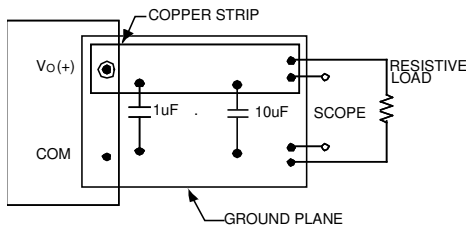

NOTE: All voltage measurements to be taken at the module terminals, as shown above. If sockets are used then Kelvin connections are required at the module terminals to avoid measurement errors due to socket contact resistance.

Figure 26. Output Ripple and Noise Test Setup.

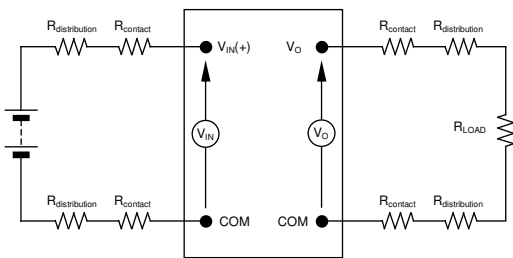

NOTE: All voltage measurements to be taken at the module terminals, as shown above. If sockets are used then Kelvin connections are required at the module terminals to avoid measurement errors due to socket contact resistance.

Figure 27. Output Voltage and Efficiency Test Setup.

$$\text{Efficiency } \eta = \frac{V_O \cdot I_O}{V_{IN} \cdot I_{IN}} \times 100 \%$$

## Design Considerations

The ATM030 module should be connected to a low-impedance source. A highly inductive source can affect the stability of the module. An input capacitor must be placed directly adjacent to the input pin of the module, to minimize input ripple voltage and ensure module stability.

To minimize input voltage ripple, low-ESR ceramic capacitors are recommended at the input of the module. Figure 28 shows the input ripple voltage for various output voltages at 30A of load current with 1x47 µF or 2x47 µF ceramic capacitors and an input of 3.3V.

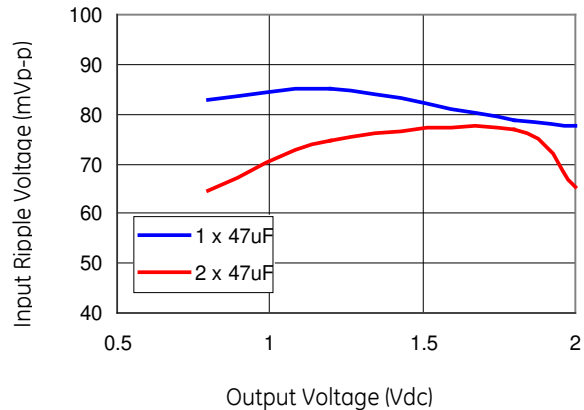

Figure 28. Input ripple voltage for various output voltages with 1x47 µF or 2x47 µF ceramic capacitors at the input (30A load). Input voltage is 3.3V.

## Safety Considerations

For safety agency approval the power module must be installed in compliance with the spacing and separation requirements of the end-use safety agency standards, i.e., UL 60950, CSA C22.2 No. 60950-00, EN60950 (VDE 0850) (IEC60950, 3<sup>rd</sup> edition) Licensed.

For the converter output to be considered meeting the requirements of safety extra-low voltage (SELV), the input must meet SELV requirements. The power module has extra-low voltage (ELV) outputs when all inputs are ELV.

An input fuse for the module is recommended. As an option to using a fuse, no fuse is required, if the module is powered by a power source with current limit protection and the module is evaluated in the end-use equipment.

## Feature Descriptions

### Remote On/Off

The ATM030 SMT power modules feature a On/Off pin for remote On/Off operation. If not using the On/Off pin, connect the pin to ground (the module will be ON). The On/Off signal ( $V_{on/off}$ ) is referenced to ground. Circuit configuration for remote On/Off operation of the module using the On/Off pin is shown in Figure 29.

During a Logic High on the On/Off pin (transistor Q1 is OFF), the module remains OFF. The external resistor  $R_X$  should be chosen to maintain 2.5V minimum on the On/Off pin to ensure that the module is OFF when transistor Qx is in the OFF state. A suitable values for  $R_X$  is 3K for 5Vin. During Logic-Low when Qx is turned ON, the module is turned ON.

# 30A Austin MegaLynx™: Non-Isolated DC-DC Power Modules

2.7Vdc – 4.0Vdc input; 0.8Vdc to 2.0Vdc output; 30A Output Current

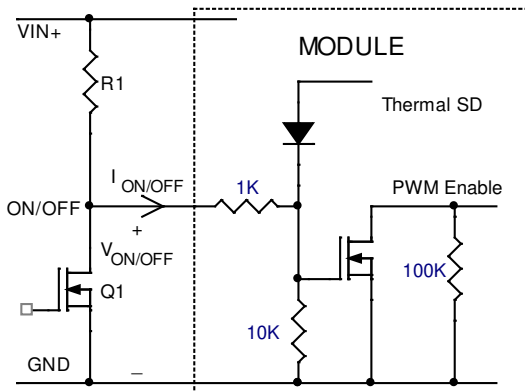

**Figure 29. Remote On/Off Implementation using ON/OFF .**

The On/Off pin can also be used to synchronize the output voltage start-up and shutdown of multiple modules in parallel. By connecting On/Off pins of multiple modules, the output start-up can be synchronized (please refer to characterization curves). When On/Off pins are connected together, all modules will shutdown if any one of the modules gets disabled due to undervoltage lockout or over temperature protection.

### Remote Sense

The ATM030 power modules have a Remote Sense feature to minimize the effects of distribution losses by regulating the voltage at the Remote Sense pin (See Figure 30). The voltage between the Sense pin and Vo pin must not exceed 0.5V.

The amount of power delivered by the module is defined as the output voltage multiplied by the output current ( $V_o \times I_o$ ). When using Remote Sense, the output voltage of the module can increase, which if the same output is maintained, increases the power output by the module. Make sure that the maximum output power of the module remains at or below the maximum rated power. When the Remote Sense feature is not being used, connect the Remote Sense pin to output of the module.

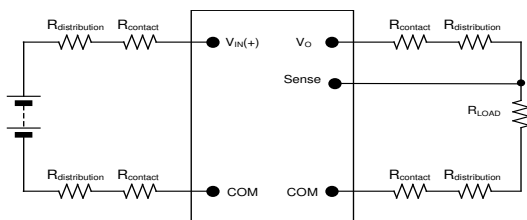

**Figure 30. Effective Circuit Configuration for Remote Sense operation.**

### Over Current Protection

To provide protection in a fault (output overload) condition, the unit is equipped with internal current-limiting circuitry and can endure current limiting continuously. At the point of current-limit inception, the unit enters hiccup mode. The unit operates normally once the output current is brought back into its specified range. The average output current during hiccup is 10%  $I_{o, max}$ .

### Over Temperature Protection

To provide protection in a fault condition, the unit is equipped with a thermal shutdown circuit. The unit will shutdown if the overtemperature threshold of 125°C is exceeded at the thermal reference point  $T_{ref}$ . The thermal shutdown is not intended as a guarantee that the unit will survive temperatures beyond its rating. Once the unit goes into thermal shutdown it will then wait to cool before attempting to restart.

### Input Under Voltage Lockout

At input voltages below the input undervoltage lockout limit, the module operation is disabled. The module will begin to operate at an input voltage above the undervoltage lockout turn-on threshold.

### Output Voltage Programming

The output voltage of the ATM030 module can be programmed to any voltage from 0.8dc to 2.0Vdc by connecting a resistor (shown as  $R_{trim}$  in Figure 31) between Trim and GND pins of the module. Without an external resistor between Trim and GND pins, the output of the module will be 0.8Vdc. To calculate the value of the trim resistor,  $R_{trim}$  for a desired output voltage, use the following equation:

$$R_{trim} = \left[ \frac{1200}{V_o - 0.80} - 100 \right] \Omega$$

$R_{trim}$  is the external resistor in  $\Omega$

$V_o$  is the desired output voltage

By using a  $\pm 0.5\%$  tolerance trim resistor with a TC of  $\pm 100$ ppm, a set point tolerance of  $\pm 1.5\%$  can be achieved as specified in the electrical specification. The POL Programming Tool, available at [www.gecriticalpower.com](http://www.gecriticalpower.com) under the Design Tools section, helps determine the required external trim resistor needed for a specific output voltage.

# 30A Austin MegaLynx™: Non-Isolated DC-DC Power Modules

2.7Vdc – 4.0Vdc input; 0.8Vdc to 2.0Vdc output; 30A Output Current

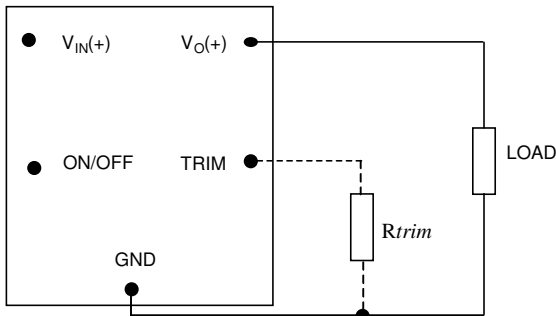

**Figure 31. Circuit configuration to program output voltage using an external resistor.**

### Voltage Margining

Output voltage margining can be implemented in the Austin MegaLynx™ modules by connecting a resistor,  $R_{margin-up}$ , from the Trim pin to the ground pin for margining-up the output voltage and by connecting a resistor,  $R_{margin-down}$ , from the Trim pin to output pin for margining-down. Figure 32 shows the circuit configuration for output voltage margining. The POL Programming Tool, available at [www.gecriticalpower.com](http://www.gecriticalpower.com) under the Design Tools section, also calculates the values of  $R_{margin-up}$  and  $R_{margin-down}$  for a specific output voltage and % margin. Please consult your local GE technical representative for additional details.

### Voltage Sequencing

The Austin MegaLynx™ series of modules include a sequencing feature that enables users to implement various types of output voltage sequencing in their applications. This is accomplished via an additional sequencing pin. When not using the sequencing feature, either leave the SEQ pin unconnected or tied to  $V_{IN}$ .

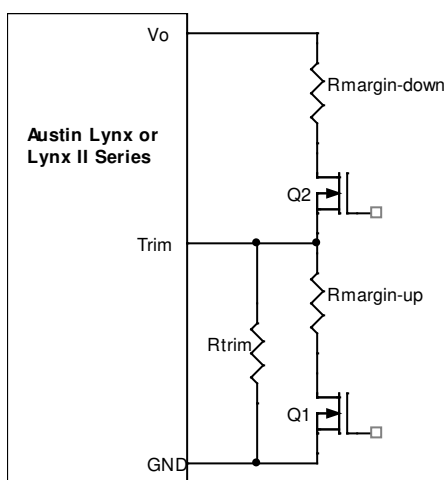

**Figure 32. Circuit Configuration for margining Output voltage.**

For proper voltage sequencing, first, input voltage is applied to the module. The On/Off pin of the module is or tied to GND so that the module is ON by default. After applying input voltage to the module, a minimum of 10msec delay is required before applying voltage on the SEQ pin. After 10msec delay, an analog voltage is applied to the SEQ pin and the output voltage of the module will track this voltage on a one-to-one volt bases until output reaches the set-point voltage. To initiate simultaneous shutdown of the modules, the SEQ pin voltage is lowered in a controlled manner. Output voltage of the modules tracks the voltages below their set-point voltages on a one-to-one basis. A valid input voltage must be maintained until the tracking and output voltages reach ground potential.

When using the EZ-SEQUENCE™ feature to control start-up of the module, pre-bias immunity feature during start-up is disabled. The pre-bias immunity feature of the module relies on the module being in the diode-mode during start-up. When using the EZ-SEQUENCE™ feature, modules goes through an internal set-up time of 10msec, and will be in synchronous rectification mode when voltage at the SEQ pin is applied. This will result in sinking current in the module if pre-bias voltage is present at the output of the module. When pre-bias immunity during start-up is required, the EZ-SEQUENCE™ feature must be disabled. For additional guidelines on using EZ-SEQUENCE™ feature of Austin MegaLynx modules, contact the Tyco Power Systems Technical representative for the application note on output voltage sequencing.

### Active Load Sharing (-P Option)

For additional power requirements, the ATM030 series power module is also available with a parallel option. Up to five modules can be configured, in parallel, with active load sharing. Good layout techniques should be observed when using multiple units in parallel. To implement forced load sharing, the following connections should be made:

- The share pins of all units in parallel must be connected together. The path of these connections should be as direct as possible.
- All remote-sense pins should be connected to the power bus at the same point, i.e., connect all the SENSE(+) pins to the (+) side of the bus. Close proximity and directness are necessary for good noise immunity

Some special considerations apply for design of converters in parallel operation:

When sizing the number of modules required for parallel operation, take note of the fact that current sharing has some tolerance. In addition, under transient conditions such as a dynamic load change and during startup, all converter output currents will not be equal. To allow for such variation and avoid the likelihood of a converter shutting off due to a current overload, the total capacity of the paralleled system should be no more than 75% of the sum of the individual converters. As an example, for a system of four ATM030A0X3-SR converters the parallel, the total current drawn should be less that 75% of  $4 \times 30A$  or 90A.

## 30A Austin MegaLynx™: Non-Isolated DC-DC Power Modules

2.7Vdc – 4.0Vdc input; 0.8Vdc to 2.0Vdc output; 30A Output Current

- When sizing the number of modules required for parallel operation, take note of the fact that current sharing has some tolerance. In addition, under transient conditions such as a dynamic load change and during startup, all converter output currents will not be equal. To allow for such variation and avoid the likelihood of a converter shutting off due to a current overload, the total capacity of the paralleled system should be no more than 75% of the sum of the individual converters. As an example, for a system of four ATM030A0X3-SR converters the parallel, the total current drawn should be less than 75% of (4 x 30A) , i.e. less than 90A.
- All modules should be turned on and off together. This is so that all modules come up at the same time avoiding the problem of one converter sourcing current into the other leading to an overcurrent trip condition. To ensure that all modules come up simultaneously, the on/off pins of all paralleled converters should be tied together and the converters enabled and disabled using the on/off pin.
- The share bus is not designed for redundant operation and the system will be non-functional upon failure of one of the unit when multiple units are in parallel. In particular, if one of the converters shuts down during operation, the other converters may also shut down due to their outputs hitting current limit. In such a situation, unless a coordinated restart is ensured, the system may never properly restart since different converters will try to restart at different times causing an overload condition and subsequent shutdown. This situation can be avoided by having an external output voltage monitor circuit that detects a shutdown condition and forces all converters to shut down and restart together.

When not using the parallel feature, leave the share pin open.

# 30A Austin MegaLynx™: Non-Isolated DC-DC Power Modules

2.7Vdc – 4.0Vdc input; 0.8Vdc to 2.0Vdc output; 30A Output Current

## Thermal Considerations

Power modules operate in a variety of thermal environments; however, sufficient cooling should always be provided to help ensure reliable operation.

Considerations include ambient temperature, airflow, module power dissipation, and the need for increased reliability. A reduction in the operating temperature of the module will result in an increase in reliability. The thermal data presented here is based on physical measurements taken in a wind tunnel. The test set-up is shown in Figure 33. Note that the airflow is parallel to the long axis of the module as shown in Figure 34. The derating data applies to airflow in either direction of the module's long axis.

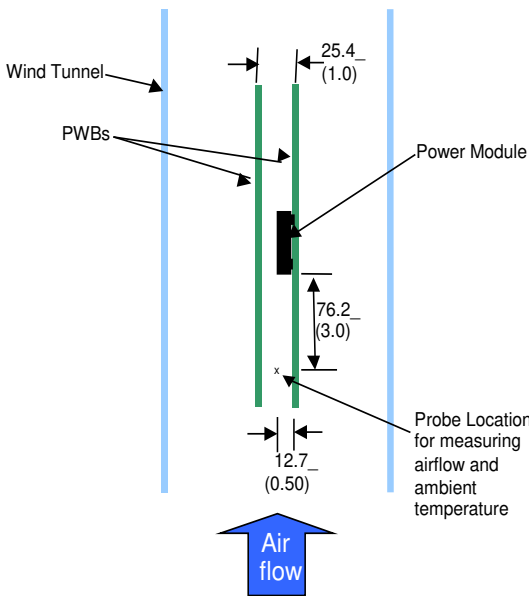

Figure 33. Thermal Test Up

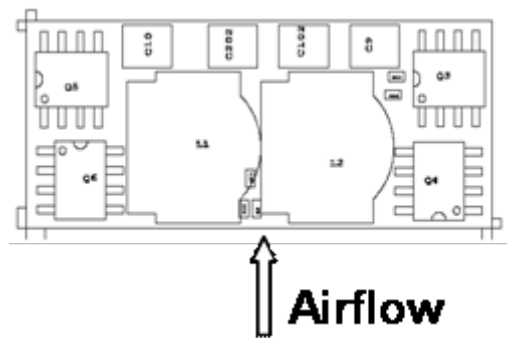

Figure 34. Airflow direction for thermal testing.

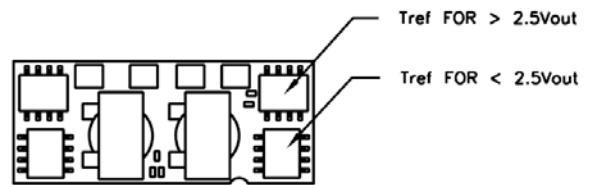

Figure 35. Tref Temperature measurement location.

The thermal reference points,  $T_{ref}$  used in the specifications are shown in Figure 35. For reliable operation the temperatures at these points should not exceed 125°C. The output power of the module should not exceed the rated power of the module ( $V_{o,set} \times I_{o,max}$ ).

Please refer to the Application Note "Thermal Characterization Process For Open-Frame Board-Mounted Power Modules" for a detailed discussion of thermal aspects including maximum device temperatures.

# 30A Austin MegaLynx™: Non-Isolated DC-DC Power Modules

2.7Vdc – 4.0Vdc input; 0.8Vdc to 2.0Vdc output; 30A Output Current

## Mechanical Outline of Module (ATM030A0X3-SRPH)

Dimensions are in millimeters and (inches).

Tolerances: x.x mm ± 0.5 mm (x.xx in. ± 0.02 in.) [unless otherwise indicated]

x.xx mm ± 0.25 mm (x.xxx in ± 0.010 in.)

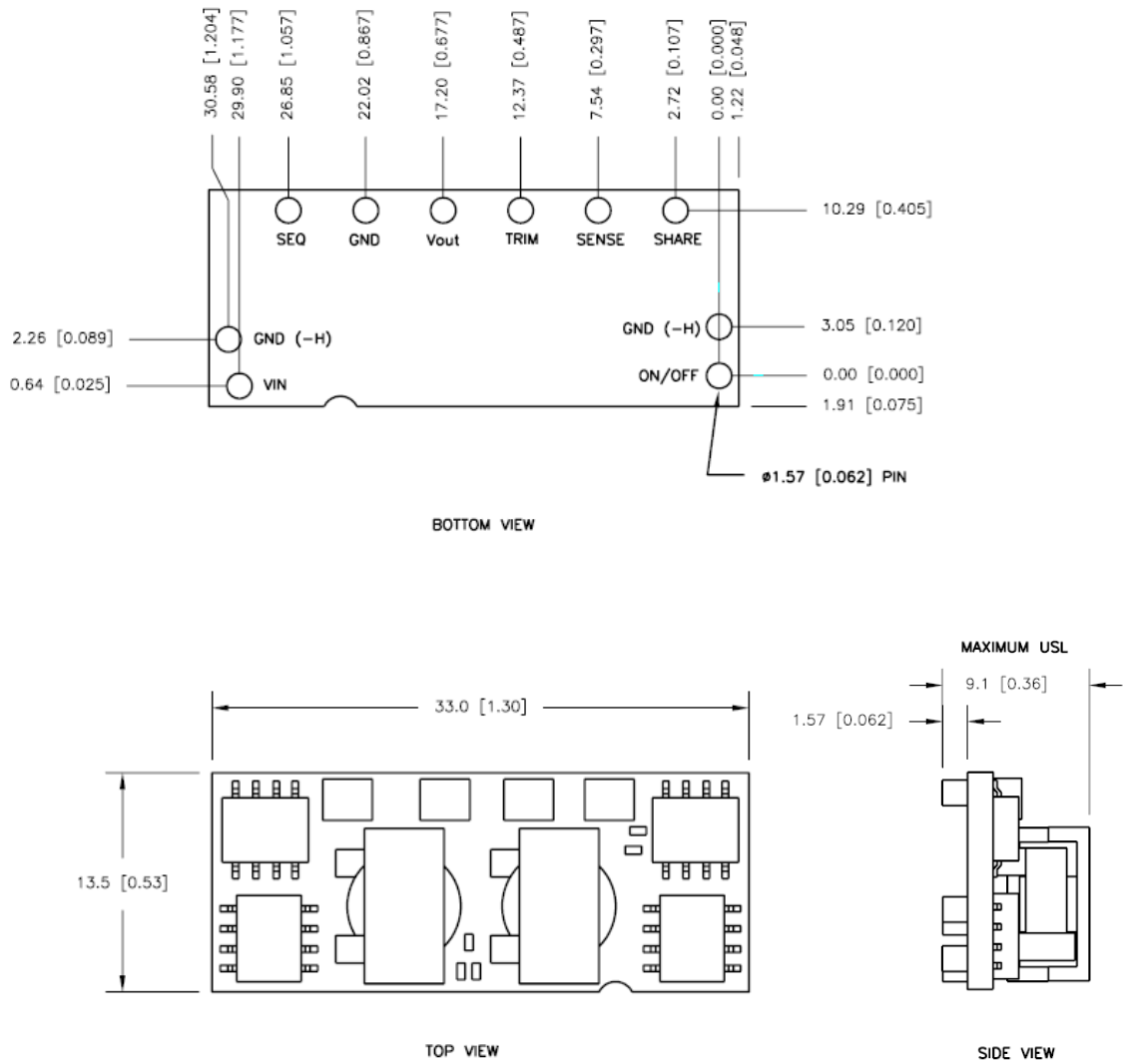

**Note:** For the ATM030A0X3-SRH module, the SHARE pin is omitted since these modules are not capable of being paralleled.

# 30A Austin MegaLynx™: Non-Isolated DC-DC Power Modules

2.7Vdc – 4.0Vdc input; 0.8Vdc to 2.0Vdc output; 30A Output Current

## Recommended Pad Layout (ATM030A0X3-SRPH)

Dimensions are in millimeters and (inches).

Tolerances: x.x mm ± 0.5 mm (x.xx in. ± 0.02 in.) [unless otherwise indicated]

x.xx mm ± 0.25 mm (x.xxx in ± 0.010 in.)

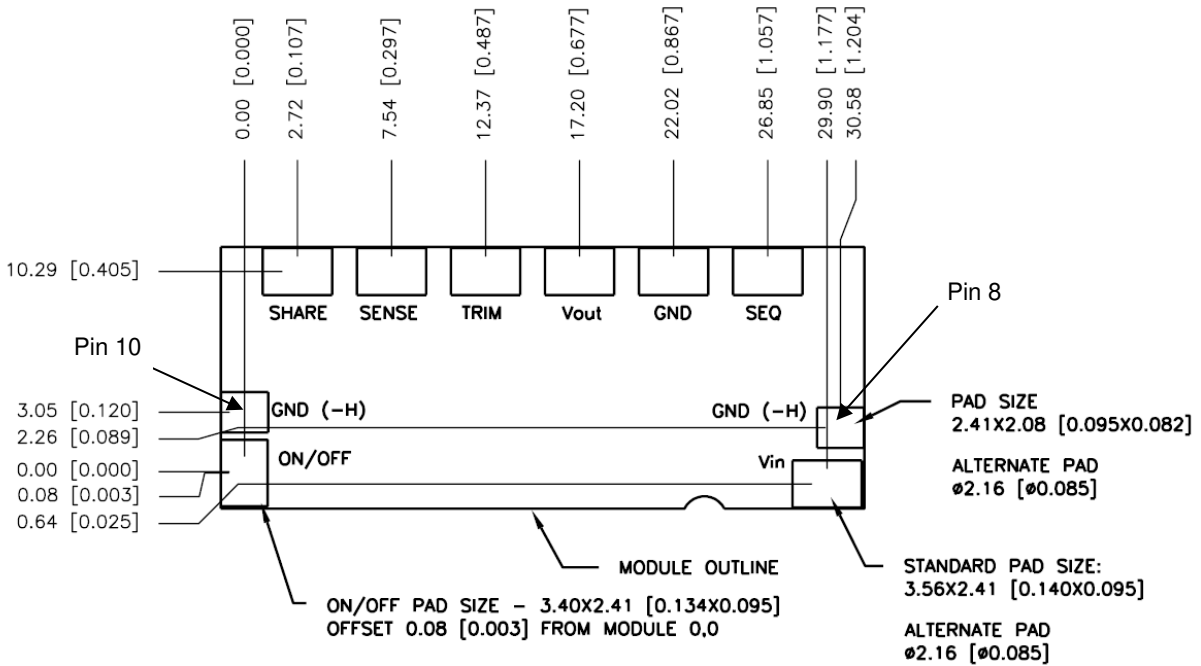

PIN	FUNCTION	PIN	FUNCTION
1	On/Off	6	Trim
2	VIN	7	Sense
3	SEQ	8	GND
4	GND	9	SHARE
5	VOUT	10	GND

**Note:** For the ATM030A0X3-SRPH module, the SHARE pin is not present since these modules are not capable of being paralleled.



# 30A Austin MegaLynx™: Non-Isolated DC-DC Power Modules

2.7Vdc – 4.0Vdc input; 0.8Vdc to 2.0Vdc output; 30A Output Current

## Mechanical Outline of Module (ATM030A0X3-SRP)

Dimensions are in millimeters and (inches).

Tolerances: x.x mm ± 0.5 mm (x.xx in. ± 0.02 in.) [unless otherwise indicated]

x.xx mm ± 0.25 mm (x.xxx in ± 0.010 in.)

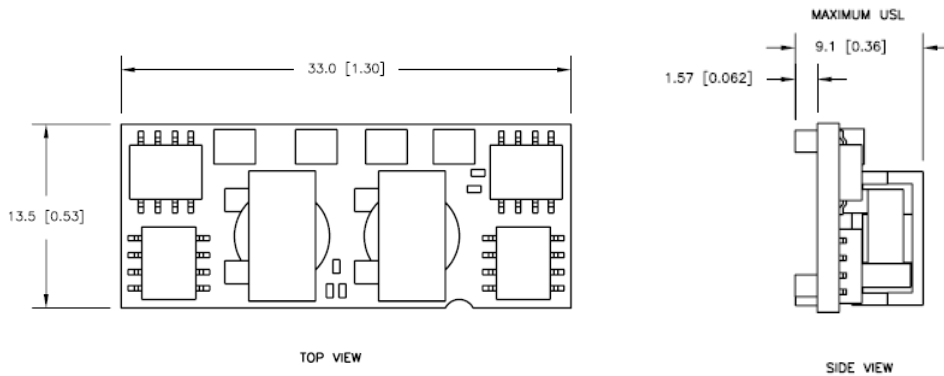
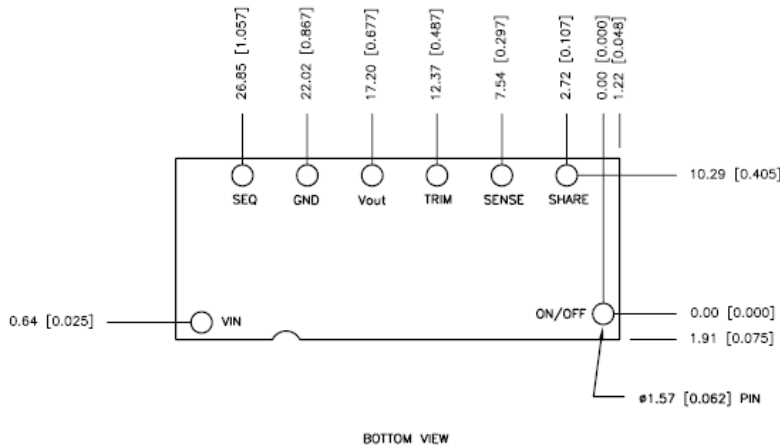

**Note:** For the ATM030A0X3-SR module, the SHARE pin is omitted since these modules are not capable of being paralleled.

# 30A Austin MegaLynx™: Non-Isolated DC-DC Power Modules

2.7Vdc – 4.0Vdc input; 0.8Vdc to 2.0Vdc output; 30A Output Current

## Recommended Pad Layout (ATM030A0X3-SRP)

Dimensions are in millimeters and (inches).

Tolerances: x.x mm ± 0.5 mm (x.xx in. ± 0.02 in.) [unless otherwise indicated]

x.xx mm ± 0.25 mm (x.xxx in ± 0.010 in.)

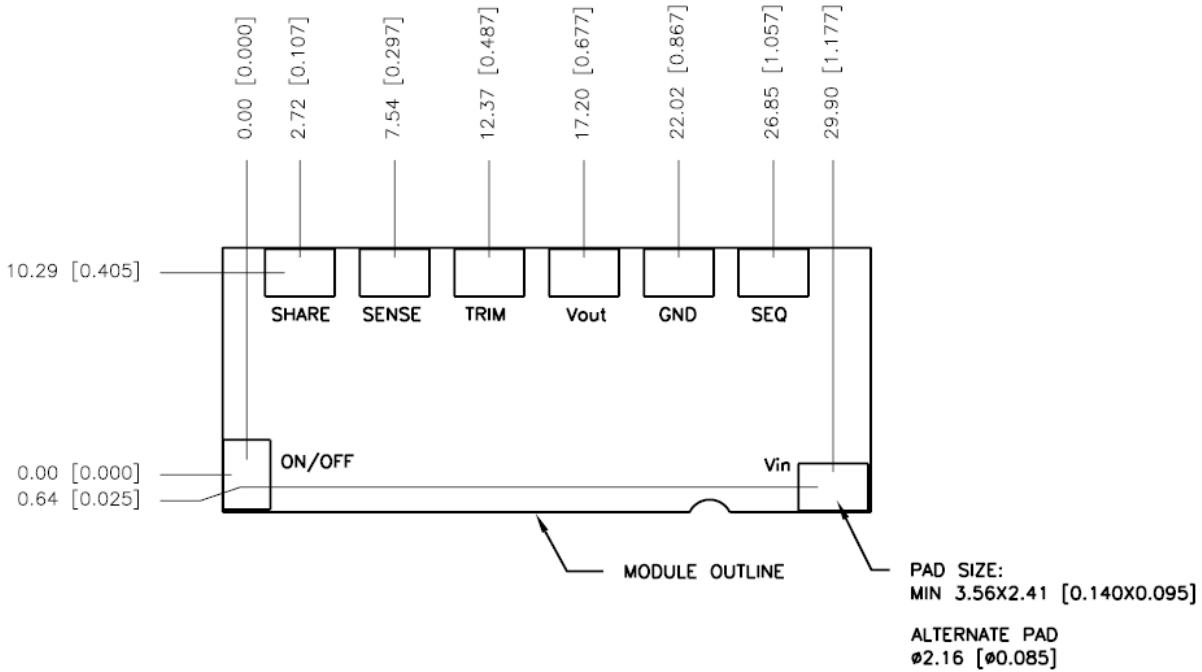

PIN	FUNCTION	PIN	FUNCTION
1	On/Off	6	Trim
2	Vin	7	Sense
3	SEQ	8	No Pin
4	GND	9	Share
5	Vout	10	No Pin

**Note:** For the ATM030A0X3-SR module, the SHARE pin is not used since these modules are not capable of being paralleled.

# 30A Austin MegaLynx™: Non-Isolated DC-DC Power Modules

2.7Vdc – 4.0Vdc input; 0.8Vdc to 2.0Vdc output; 30A Output Current

## Packaging Details

The ATM030 SMT module is supplied in tape & reel as standard. Modules are shipped in quantities of 200 modules per reel.

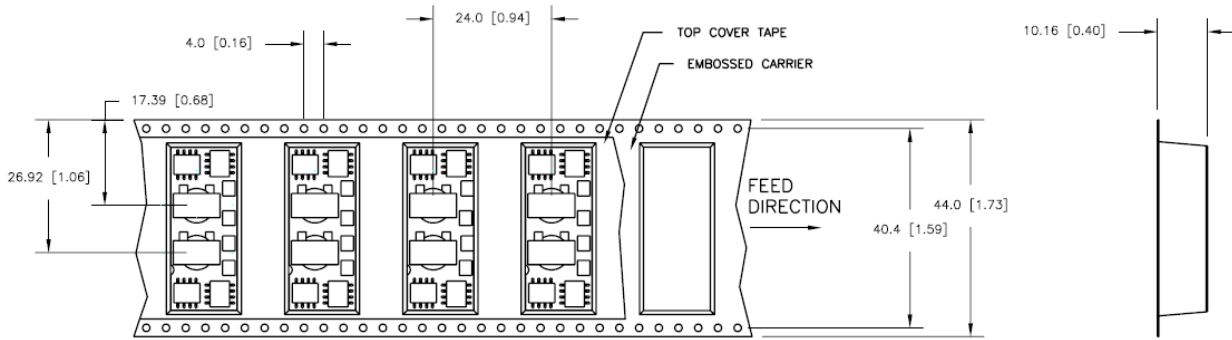

NOTE: CONFORMS TO EIA-481 STANDARD



All Dimensions are in millimeters and (in inches).

### Reel Dimensions

- Outside diameter: 330.2 (13.0)
- Inside diameter: 177.8 (7.0)
- Tape Width: 44.0 (1.73)

# 30A Austin MegaLynx™: Non-Isolated DC-DC Power Modules

2.7Vdc – 4.0Vdc input; 0.8Vdc to 2.0Vdc output; 30A Output Current

## Surface Mount Information

### Pick and Place

The Austin MegaLynx™ SMT modules use an open frame construction and are designed for a fully automated assembly process. The modules are fitted with a label designed to provide a large surface area for pick and place operations. The label meets all the requirements for surface mount processing, as well as safety standards, and is able to withstand reflow temperatures of up to 300°C. The label also carries product information such as product code, serial number and location of manufacture.

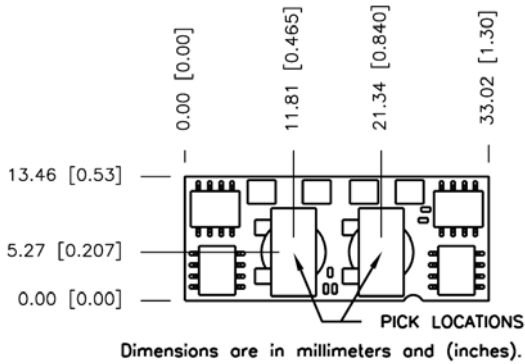

Figure 36. Pick and Place Location.

### Nozzle Recommendations

The module weight has been kept to a minimum by using open frame construction. Even so, these modules have a relatively large mass when compared to conventional SMT components. Variables such as nozzle size, tip style, vacuum pressure and pick & placement speed should be considered to optimize this process. The minimum recommended inside nozzle diameter for reliable operation is 3mm. The maximum nozzle outer diameter, which will safely fit within the allowable component spacing, is 5 mm max.

### Tin Lead Soldering

The ATM030 modules are lead free modules and can be soldered either in a lead-free solder process or in a conventional Tin/Lead (Sn/Pb) process. It is recommended that the customer review data sheets in order to customize the solder reflow profile for each application board assembly. The following instructions must be observed when soldering these units. Failure to observe these instructions may result in the failure of or cause damage to the modules, and can adversely affect long-term reliability.

In a conventional Tin/Lead (Sn/Pb) solder process peak reflow temperatures are limited to less than 235°C. Typically, the eutectic solder melts at 183°C, wets the land, and subsequently wicks the device connection. Sufficient time must be allowed to fuse the plating on the connection to ensure a reliable solder joint. There are several types of SMT reflow technologies currently used in the industry. These surface mount power modules can be reliably soldered using natural forced convection, IR (radiant infrared), or a combination of convection/IR. For reliable soldering the solder reflow profile should be established by accurately measuring the modules CP connector temperatures.

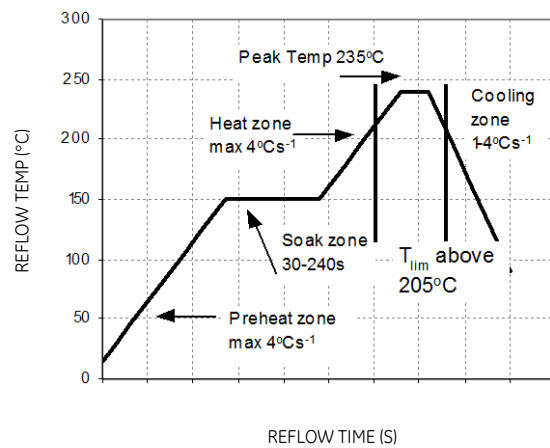

Figure 37. Reflow Profile for Tin/Lead (Sn/Pb) process.

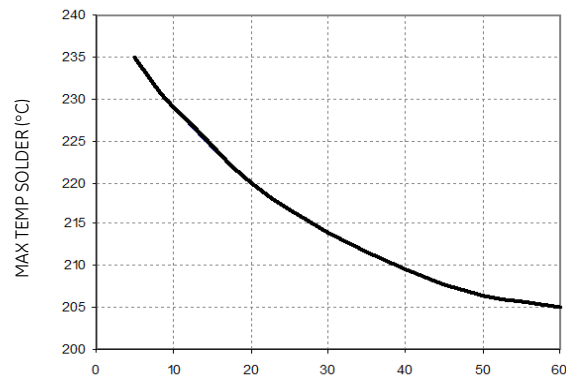

Figure 38. Time Limit Curve Above 205°C Reflow for Tin Lead (Sn/Pb) process.

## 30A Austin MegaLynx™: Non-Isolated DC-DC Power Modules

2.7Vdc – 4.0Vdc input; 0.8Vdc to 2.0Vdc output; 30A Output Current

### Surface Mount Information (continued)

#### Lead Free Soldering

The -Z version MegaLynx ATM SMT modules are lead-free (Pb-free) and RoHS compliant and are both forward and backward compatible in a Pb-free and a SnPb soldering process. Failure to observe the instructions below may result in the failure of or cause damage to the modules and can adversely affect long-term reliability.

#### Pb-free Reflow Profile

Power Systems will comply with J-STD-020 Rev. C (Moisture/Reflow Sensitivity Classification for Nonhermetic Solid State Surface Mount Devices) for both Pb-free solder profiles and MSL classification procedures. This standard provides a recommended forced-air-convection reflow profile based on the volume and thickness of the package (table 4-2). The suggested Pb-free solder paste is Sn/Ag/Cu (SAC). The recommended linear reflow profile using Sn/Ag/Cu solder is shown in Figure 39.

#### MSL Rating

The Austin MegaLynx™ ATM SMT modules have a MSL rating of 2a.

#### Storage and Handling

The recommended storage environment and handling procedures for moisture-sensitive surface mount packages is detailed in J-STD-033 Rev. A (Handling, Packing, Shipping and Use of Moisture/Reflow Sensitive Surface Mount Devices). Moisture barrier bags (MBB) with desiccant are required for MSL ratings of 2 or greater. These sealed packages should not be broken until time of use. Once the original package is broken, the floor life of the product at conditions of  $\leq 30^{\circ}\text{C}$  and 60% relative humidity varies according to the MSL rating (see J-STD-033A). The shelf life for dry packed SMT packages will be a minimum of 12 months from the bag seal date, when stored at the following conditions:  $< 40^{\circ}\text{C}$ ,  $< 90\%$  relative humidity.

#### Post Solder Cleaning and Drying Considerations

Post solder cleaning is usually the final circuit-board assembly process prior to electrical board testing. The result of inadequate cleaning and drying can affect both the reliability of a power module and the testability of the finished circuit-board assembly. For guidance on appropriate soldering, cleaning and drying procedures, refer to *Board Mounted Power Modules: Soldering and Cleaning* Application Note (AN04-001).

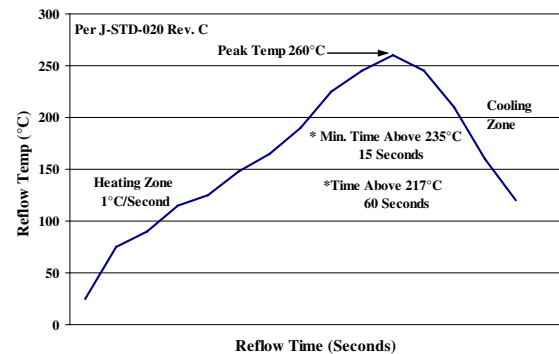

Figure 39. Recommended linear reflow profile using Sn/Ag/Cu solder.

## 30A Austin MegaLynx™: Non-Isolated DC-DC Power Modules

2.7Vdc – 4.0Vdc input; 0.8Vdc to 2.0Vdc output; 30A Output Current

### Ordering Information

Please contact your GE Sales Representative for pricing, availability and optional features.

**Table 1: Device Codes**

Product codes	Input Voltage	Output Voltage	Output Current	On/Off Logic	Connector Type	Comcodes
ATM030A0X3-SR	2.7 – 4.0Vdc	0.8 – 2.0Vdc	30A	Negative	SMT	CC109112315
ATM030A0X3-SRZ	2.7 – 4.0Vdc	0.8 – 2.0Vdc	30A	Negative	SMT	CC109112397
ATM030A0X3-SRH	2.7 – 4.0Vdc	0.8 – 2.0Vdc	30A	Negative	SMT	CC109112323
ATM030A0X3-SRHZ	2.7 – 4.0Vdc	0.8 – 2.0Vdc	30A	Negative	SMT	CC109112406
ATM030A0X3-SRPH	2.7 – 4.0Vdc	0.8 – 2.0Vdc	30A	Negative	SMT	CC109112331
ATM030A0X3-SRPHZ	2.7 – 4.0Vdc	0.8 – 2.0Vdc	30A	Negative	SMT	CC109112414

**Table 2. Device Options**

Option	Device Code Suffix
Current Share	-P
2 Extra ground pins	-H
RoHS Compliant	-Z

## Contact Us

For more information, call us at

USA/Canada:

**+1 877 546 3243**, or +1 972 244 9288

Asia-Pacific:

+86.021.54279977\*808

Europe, Middle-East and Africa:

+49.89.878067-280

[www.gecriticalpower.com](http://www.gecriticalpower.com)



GE Critical Power reserves the right to make changes to the product(s) or information contained herein without notice, and no liability is assumed as a result of their use or application. No rights under any patent accompany the sale of any such product(s) or information.