

102100-1 ✓ ACTIVE

AMPMODU | AMPMODU MOD 1

TE Internal #: 102100-1

Connector Contact, Socket, .15 in [3.81 mm] Centerline, Gold, 22 – 18 AWG Wire Size, .3 – .9 mm<sup>2</sup> Wire Size, Straight, Wire & Cable, 5 A, AMPMODU MOD 1

[View on TE.com >](#)



Connectors > PCB Connectors > Board-to-Board Connectors > Board-to-Board Connector Contacts

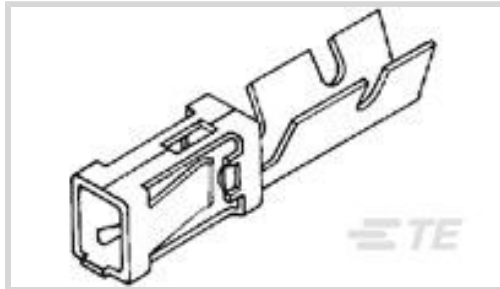

Contact Type: **Socket**

Centerline (Pitch): **3.81 mm [ .15 in ]**

Contact Mating Area Plating Material: **Gold**

Wire Size: **.3 – .9 mm<sup>2</sup>**

## Features

### Product Type Features

Applied Pressure	High
Connector & Contact Terminates To	Wire & Cable

### Electrical Characteristics

Dielectric Withstanding Voltage (Max)	1200 VAC
Insulation Resistance	5000 MΩ
Contact Resistance	12 mΩ

### Contact Features

Contact Mating Area Plating Material Thickness	.381 μm[15 μin]
PCB Contact Termination Area Plating Material	Gold Flash
Contact Base Material	Phosphor Bronze
Contact Type	Socket
Contact Mating Area Plating Material	Gold
Contact Orientation	Straight
Contact Current Rating (Max)	5 A

### Mechanical Attachment

Wire Insulation Support	With
PCB Mount Retention	Without

### Housing Features

Centerline (Pitch)	3.81 mm[.15 in]
--------------------	-----------------

### Dimensions

Compatible Insulation Diameter Range	1.3 – 2.29 mm [.051 – .09 in]
Wire Size	.3 – .9 mm <sup>2</sup>

### Usage Conditions

Operating Temperature Range	-65 – 105 °C [-85 – 221 °F]
-----------------------------	-----------------------------

### Operation/Application

Circuit Application	Signal
---------------------	--------

### Packaging Features

Packaging Quantity	5000
Packaging Method	Reel

### Other

Connector Contacts Comment	Applicators also available for AMPOMATOR Lead Making Machines and Stripper/Crimper Machines. Consult AMP, Inc., Part No. 843473-1 is an extraction tool for the Crimp Snap-In contacts.
----------------------------	---

### Product Compliance

[For compliance documentation, visit the product page on TE.com>](#)

EU RoHS Directive 2011/65/EU	Compliant
EU ELV Directive 2000/53/EC	Compliant
China RoHS 2 Directive MIIT Order No 32, 2016	No Restricted Materials Above Threshold
EU REACH Regulation (EC) No. 1907/2006	Current ECHA Candidate List: JUNE 2023 (235) Candidate List Declared Against: JAN 2023 (233) Does not contain REACH SVHC
Halogen Content	Low Halogen - Br, Cl, F, I < 900 ppm per homogenous material. Also BFR/CFR/PVC Free
Solder Process Capability	Wave solder capable to 265°C

#### Product Compliance Disclaimer

This information is provided based on reasonable inquiry of our suppliers and represents our current actual knowledge based on the information they provided. This information is subject to change. The part numbers that TE has identified as EU RoHS compliant have a maximum concentration of 0.1% by weight in homogenous materials for lead, hexavalent chromium, mercury, PBB, PBDE, DBP, BBP, DEHP, DIBP, and 0.01% for cadmium, or qualify for an exemption to these limits as defined in the Annexes of Directive 2011/65/EU (RoHS2). Finished electrical and electronic equipment products will be CE marked as required by Directive 2011/65/EU. Components may not be CE marked. Additionally, the part



numbers that TE has identified as EU ELV compliant have a maximum concentration of 0.1% by weight in homogenous materials for lead, hexavalent chromium, and mercury, and 0.01% for cadmium, or qualify for an exemption to these limits as defined in the Annexes of Directive 2000/53/EC (ELV). Regarding the REACH Regulation, the information TE provides on SVHC in articles for this part number is based on the latest European Chemicals Agency (ECHA) 'Guidance on requirements for substances in articles' posted at this URL: <https://echa.europa.eu/guidance-documents/guidance-on-reach>

## Compatible Parts



TE Part # 843473-1  
EXTRACTION TOOL



TE Part # 2-2836574-1  
OC-PA-E-FM-070F110F-001-0136



TE Part # 2-2836574-2  
OC-PA-E-FA-070F110F-001-0136



TE Part # 2836574-1  
OC-AT-E-FM-070F110F-001-0136



TE Part # 2836574-2  
OC-AT-E-FA-070F110F-001-0136



TE Part # 574868  
DAHT TAPER PIN FASTON 24-22 ASSY



TE Part # 7-2836574-7  
OC-070F110F-CRIMPTOOLINGKIT

## Also in the Series | AMPMODU MOD 1

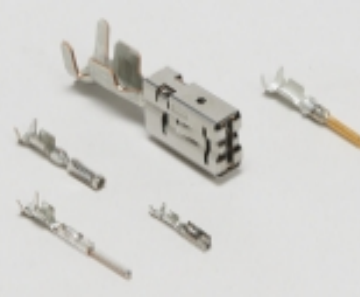

Automotive Terminals(6)



Board-to-Board Connector Contacts (107)

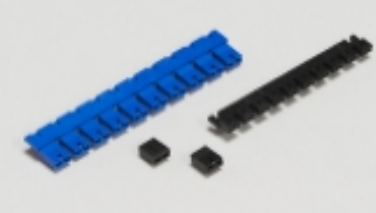

Board-to-Board Jumpers & Shunts(5)



Insertion & Extraction Tools(1)



PCB Connector Keying(2)



PCB Headers & Receptacles(358)



Wire-to-Board Connector Assemblies & Housings(44)



Wire-to-Board Connector Contacts(2)

## Customers Also Bought



TE Part #827551-3  
Timer Connector Housing



TE Part #170780-1  
P.G RING UL.CSA(22-18)



TE Part #171822-3  
EIS REC. HSG 3P-NATURAL



TE Part #171822-2  
EIS REC. HSG 2P-NATURAL



TE Part #926887-1  
UNIV.M-N-L.PIN



TE Part #154719-2  
PL 250 REC HSG 1P NYLON RED

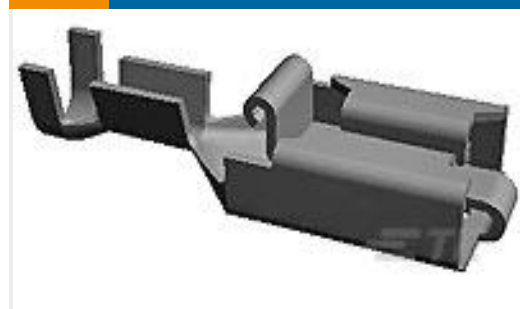

TE Part #154718-6  
250 PL MKI REC. 18-14AWG PTPB

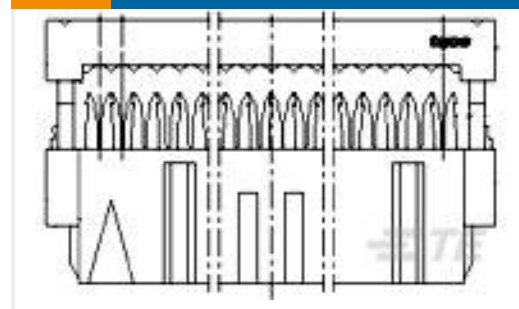

TE Part #2-215911-0  
20 WAY GREY MK II RECP



TE Part #166997-2  
20DF COSI PIN

## Documents

### Product Drawings

[MOD I RECP PLTD 15 SEL](#)

English

### Product Specifications

[Application Specification](#)

English