

## Description

The DIODES™ FMMT411FDBW is a silicon planar bipolar transistor designed for operating in avalanche mode. Tight process control and low inductance packaging combine to produce high on-current pulses with fast edges.

## Applications

- Laser diode drivers for ranging and measurement (LIDAR)
- Radar systems
- Fast edge switch generator
- High-speed pulse generators

## Features

- $I_{USB} = 35A$  typical
- $BV_{CBO} > 80V$
- $BV_{CEO} > 15V$
- Specifically Designed for Low Voltage Avalanche Mode Operation
- Low Profile 0.62mm High Package for Thin Applications
- Sidewall Tin Plating for Wettable Flanks in AOI
- **Totally Lead-Free & Fully RoHS Compliant (Notes 1 & 2)**
- **Halogen- and Antimony-Free. "Green" Device (Note 3)**
- **An automotive-compliant part is available under separate datasheet (DIODES™ [FMMT411FDBWQ](#))**

## Mechanical Data

- Package: W-DFN2020-3/SWP (Type A)
- Nominal Package Height: 0.62mm
- Package Material: Molded Plastic. "Green" Molding Compound. UL Flammability Rating 94V-0
- Moisture Sensitivity: Level 1 per J-STD-020
- Terminals: Finish - Matte Tin, Solderable per MIL-STD-202, Method 208
- Weight: 0.01 grams (Approximate)

W-DFN2020-3/SWP (Type A)



Top View

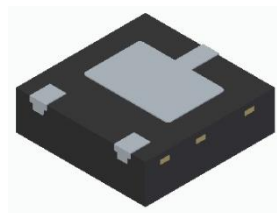

Bottom View

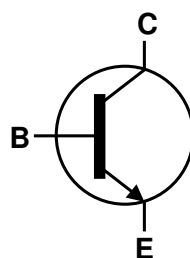

Device Symbol

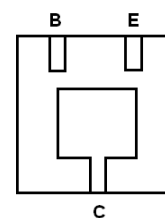

Bottom View Pin-Out

## Ordering Information (Note 4)

Part Number	Package	Marking	Reel Size (inches)	Tape Width (mm)	Packing	
					Qty.	Carrier
FMMT411FDBW-7	W-DFN2020-3	411	7	8	3000	Reel

- Notes:
1. No purposely added lead. Fully EU Directive 2002/95/EC (RoHS), 2011/65/EU (RoHS 2) & 2015/863/EU (RoHS 3) compliant.
  2. See <https://www.diodes.com/quality/lead-free/> for more information about Diodes Incorporated's definitions of Halogen- and Antimony-free, "Green" an Lead-free.
  3. Halogen- and Antimony-free "Green" products are defined as those which contain <900ppm bromine, <900ppm chlorine (<1500ppm total Br + Cl) and <1000ppm antimony compounds.
  4. For packaging details, go to our website at <https://www.diodes.com/design/support/packaging/diodes-packaging/>.

## Marking Information

U-DFN2020-3 (Type A)



411 = Product Type Marking Code  
 Y = Year: 0~9  
 W = Week: A~Z: 1~26 Week;  
     a~z; 27~52 Week; z Represents  
     52 and 53 Week  
 X = A~Z: Internal Code

## Absolute Maximum Ratings (@ $T_A = +25^\circ\text{C}$ , unless otherwise specified.)

Characteristic	Symbol	Value	Unit
Collector-Base Voltage	$V_{CBO}$	80	V
Collector-Emitter Voltage	$V_{CES}$	80	V
Collector-Emitter Voltage	$V_{CEO}$	15	V
Emitter-Base Voltage	$V_{EBO}$	7	V
Continuous Collector Current	$I_C$	5	A

## Thermal Characteristics (@ $T_A = +25^\circ\text{C}$ , unless otherwise specified.)

Characteristic	Symbol	Value	Unit
Power Dissipation	(Note 5) $P_D$	0.82	W
	(Note 6) $P_D$	1.8	W
Thermal Resistance, Junction to Ambient	(Note 5) $R_{\theta JA}$	154	$^\circ\text{C/W}$
	(Note 6) $R_{\theta JA}$	67	$^\circ\text{C/W}$
Thermal Resistance, Junction to Case	(Note 5) $R_{\theta JC}$	32	$^\circ\text{C/W}$
	(Note 6) $R_{\theta JC}$	12	$^\circ\text{C/W}$
Operating and Storage Temperature Range	$T_J, T_{STG}$	-55 to +150	$^\circ\text{C}$

## ESD Ratings (Note 7)

Characteristic	Symbol	Value	Unit	JEDEC Class
Electrostatic Discharge - Human Body Model	ESD HBM	4,000	V	3A
Electrostatic Discharge - Machine Model	ESD MM	400	V	C

- Notes:
- For a device mounted with the collector lead on MRP single-sided 1.6mm FR-4 PCB; device is measured under still air conditions whilst operating in a steady-state.
  - For a device mounted with the collector lead on 25mm x 25mm 2oz copper that is on a single-sided 1.6mm FR-4 PCB; device is measured under still air conditions whilst operating in a steady-state.
  - Refer to JEDEC specification JESD22-A114 and JESD22-A115.

**Thermal Characteristics and Derating information**

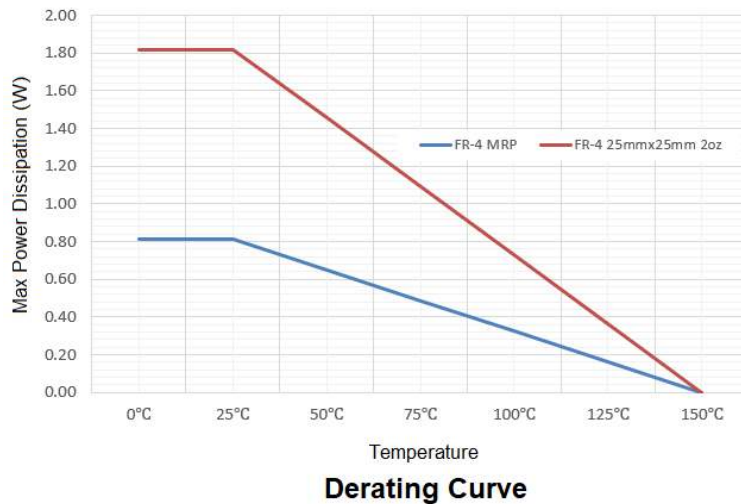
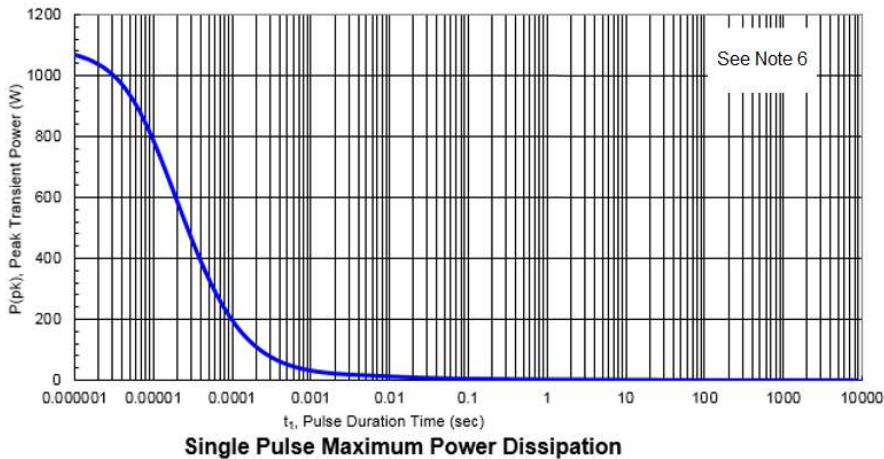
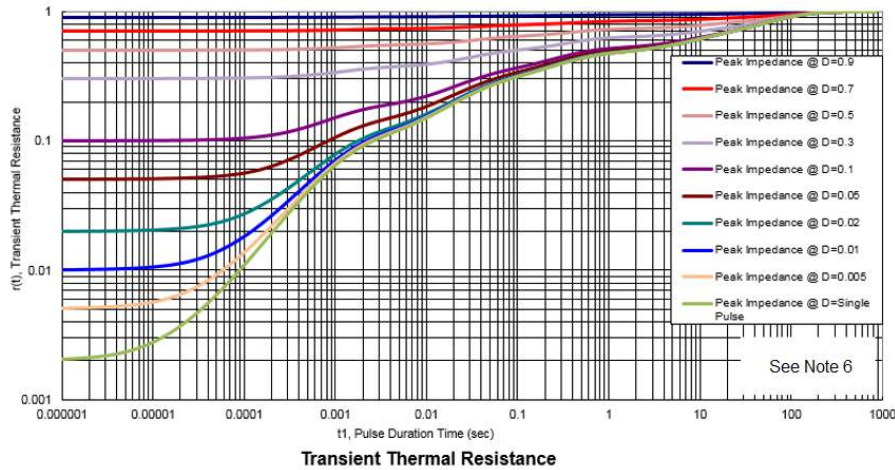

**Electrical Characteristics** (@  $T_A = +25^\circ\text{C}$ , unless otherwise specified.)

Characteristic	Symbol	Min	Typ	Max	Unit	Test Condition
Collector-Base Breakdown Voltage	$BV_{CBO}$	80	—	—	V	$I_C = 100\mu\text{A}$
Collector-Emitter Breakdown Voltage	$BV_{CES}$	80 75	—	—	V	$I_C = 100\mu\text{A}$ $T_J = -50^\circ\text{C}$ to $+150^\circ\text{C}$
Collector-Emitter Breakdown Voltage	$BV_{CEO}$	15	—	—	V	$I_C = 100\mu\text{A}$
Emitter-Base Breakdown Voltage	$BV_{EBO}$	7	—	—	V	$I_E = 100\mu\text{A}$
Collector Cutoff Current	$I_{CBO}$	—	—	100 10	nA $\mu\text{A}$	$V_{CB} = 75\text{V}$ $V_{CB} = 75\text{V}$ , $T_J = +100^\circ\text{C}$
Emitter Cutoff Current	$I_{EBO}$	—	—	20	nA	$V_{EB} = 6\text{V}$
Static Forward Current Transfer Ratio (Note 8)	$h_{FE}$	100	—	—	—	$I_C = 10\text{mA}$ , $V_{CE} = 10\text{V}$
Collector-Emitter Saturation Voltage (Note 8)	$V_{CE(sat)}$	—	—	100	mV	$I_C = 10\text{mA}$ , $I_B = 1\text{mA}$
Base-Emitter Saturation Voltage (Note 8)	$V_{BE(sat)}$	—	—	800	mV	$I_C = 10\text{mA}$ , $I_B = 1\text{mA}$
Current in Second Breakdown (Pulsed)	$I_{USB}$	—	35	—	A	$V_{CE} = 70\text{V}$ , $C_{CE} = 470\text{pF}$
Input Capacitance	$C_{ibo}$	—	49	—	pF	$V_{EB} = 0.5\text{V}$ , $f = 1\text{MHz}$
Output Capacitance	$C_{obo}$	—	17	—	pF	$V_{CB} = 20\text{V}$ , $I_E = 0$ $f = 1\text{MHz}$
Transition Frequency	$f_T$	80	110	—	MHz	$V_{CE} = 20\text{V}$ , $I_C = 10\text{mA}$ , $f = 20\text{MHz}$
Turn-On Time	$t_{d(on)}$	—	59	—	ns	$V_{CE} = 10\text{V}$ , $I_C = 100\text{mA}$ $I_{B1} = 10\text{mA}$ , $I_{B2} = -10\text{mA}$
	$t_r$	—	37	—	ns	
Turn-Off Time	$t_{d(off)}$	—	320	—	ns	
	$t_f$	—	25	—	ns	

Note: 8. Measured under pulsed conditions. Pulse width  $\leq 300\mu\text{s}$ . Duty cycle  $\leq 2\%$ .

**Typical Characteristics**

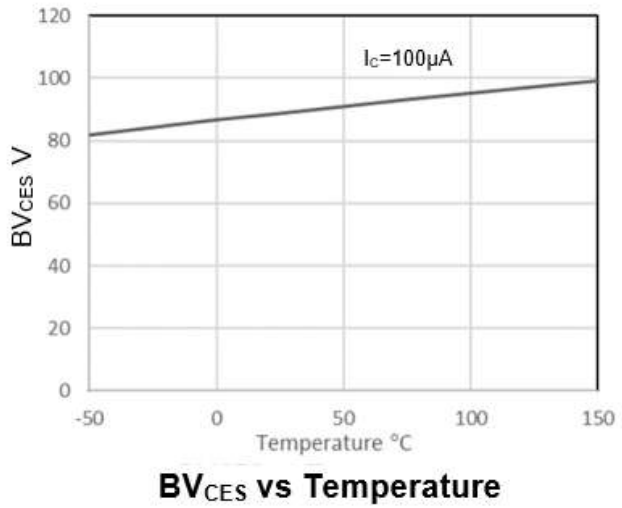
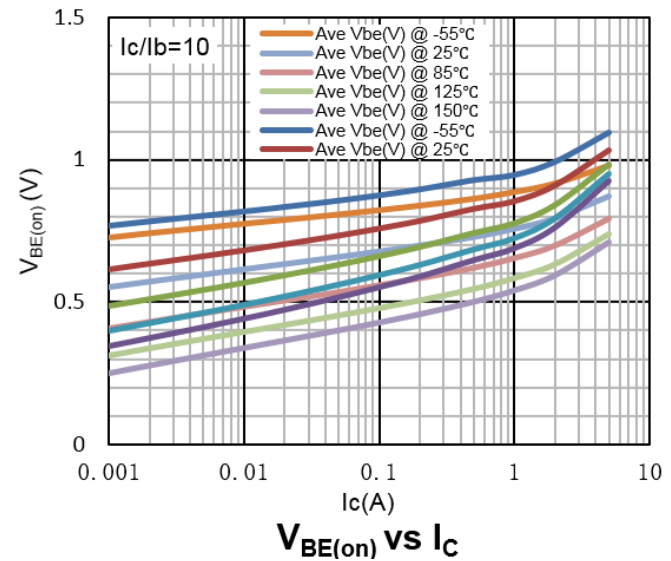
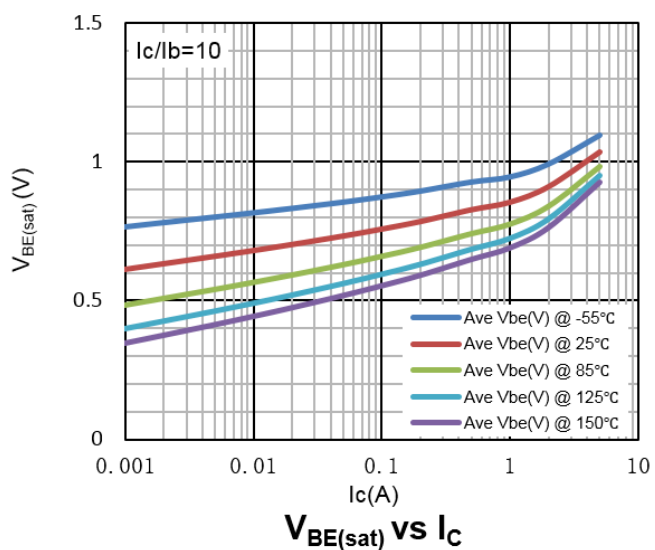
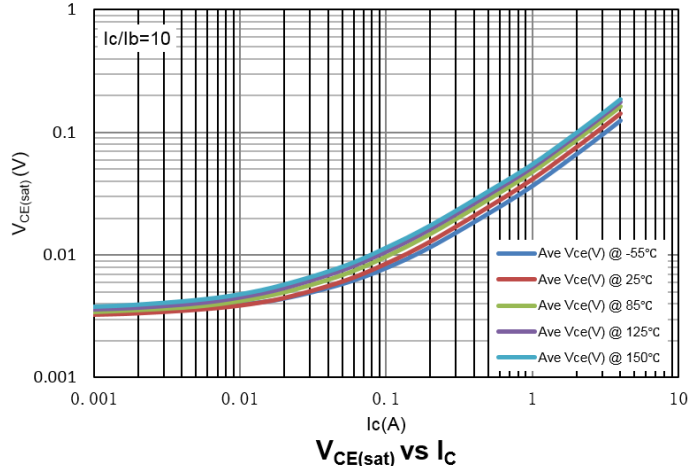
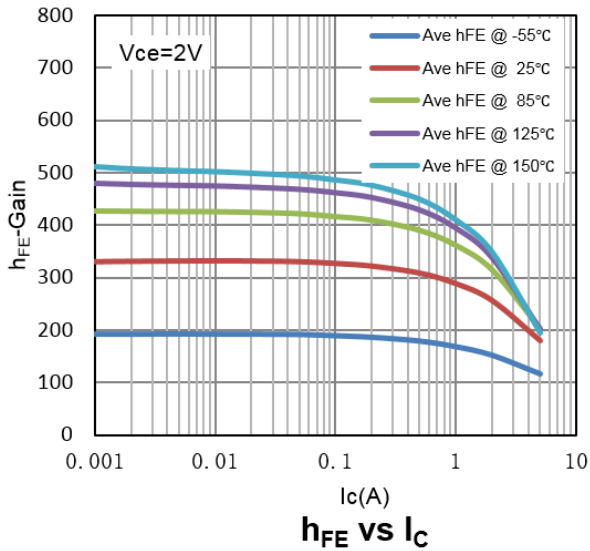

## Application Considerations

In a typical circuit a large pulse is applied to the base and the resultant energy is enough to cause the onset of avalanche multiplication. Once breakdown has been established it will continue until the energy in the breakdown region is insufficient to maintain the condition, or the crystal lattice is permanently damaged. It is important therefore to limit the total energy expended during breakdown. The typical method of achieving avalanche uses the circuit shown below, wherein the energy per cycle is set by the charge voltage and capacitance value.

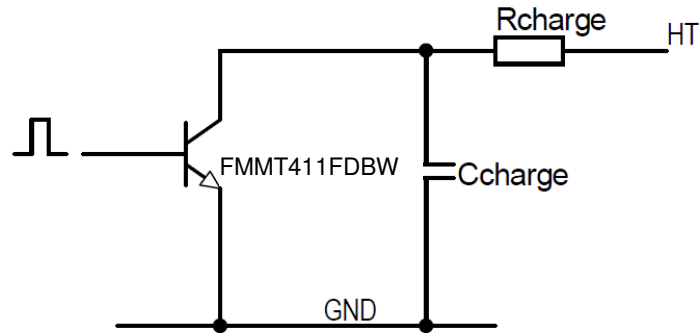

The effect of parasitic inductance in the circuit must be considered. Excessive inductance will reduce the current pulse height and slew current pulse edges. Loop area enclosed by the power circuit and track lengths should be minimized.

Thermal limitations must also be observed to ensure the transistor junction temperature is not exceeded. Avalanche power dissipation can be calculated from the energy per pulse and the pulse frequency, but PCB thermal resistance depends on many factors such as design, layout, and proximity of other components; so thermal performance should be verified by measurement.

## Package Outline Dimensions

Please see <http://www.diodes.com/package-outlines.html> for the latest version.

W-DFN2020-3/SWP (Type A)

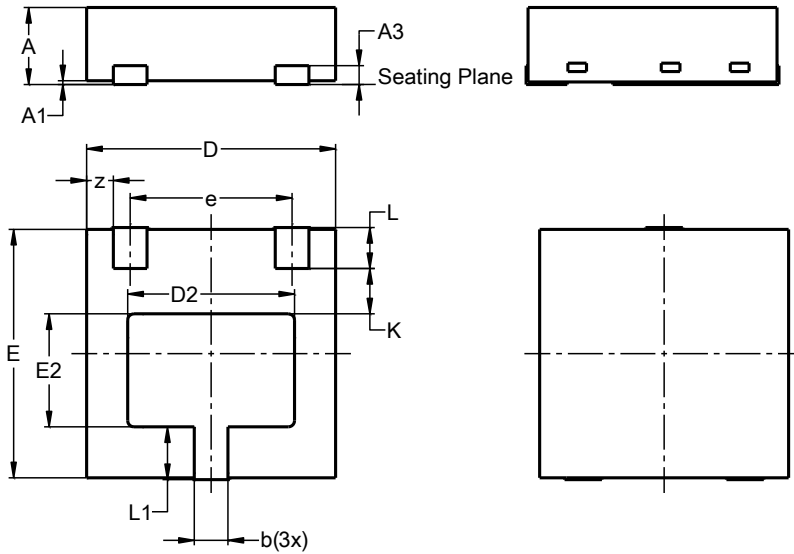

W-DFN2020-3 /SWP (Type A)			
Dim	Min	Max	Typ
A	0.57	0.67	0.62
A1	0.00	0.05	0.03
A3	—	—	0.152
b	0.22	0.32	0.27
D	1.95	2.05	2.00
D2	1.24	1.44	1.34
D4	0.56	0.76	0.66
E	1.95	2.05	2.00
E2	0.81	1.01	0.91
e	—	—	1.30
k	—	—	0.365
L	0.28	0.38	0.33
L1	0.375	0.475	0.425
z	—	—	0.215
All Dimensions in mm			

## Suggested Pad Layout

Please see <http://www.diodes.com/package-outlines.html> for the latest version.

W-DFN2020-3/SWP (Type A)

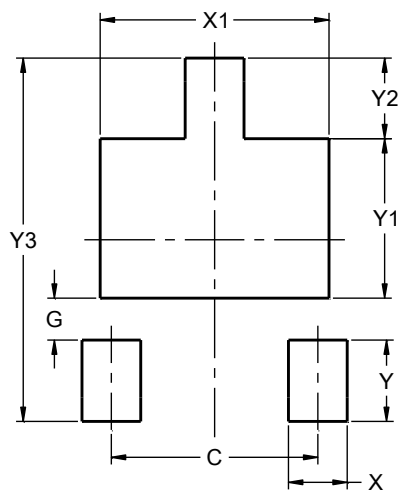

Dimensions	Value (in mm)
C	1.300
G	0.265
X	0.370
X1	1.440
Y	0.515
Y1	1.010
Y2	0.510
Y3	2.300

**IMPORTANT NOTICE**

1. DIODES INCORPORATED (Diodes) AND ITS SUBSIDIARIES MAKE NO WARRANTY OF ANY KIND, EXPRESS OR IMPLIED, WITH REGARDS TO ANY INFORMATION CONTAINED IN THIS DOCUMENT, INCLUDING, BUT NOT LIMITED TO, THE IMPLIED WARRANTIES OF MERCHANTABILITY, FITNESS FOR A PARTICULAR PURPOSE OR NON-INFRINGEMENT OF THIRD PARTY INTELLECTUAL PROPERTY RIGHTS (AND THEIR EQUIVALENTS UNDER THE LAWS OF ANY JURISDICTION).
2. The Information contained herein is for informational purpose only and is provided only to illustrate the operation of Diodes' products described herein and application examples. Diodes does not assume any liability arising out of the application or use of this document or any product described herein. This document is intended for skilled and technically trained engineering customers and users who design with Diodes' products. Diodes' products may be used to facilitate safety-related applications; however, in all instances customers and users are responsible for (a) selecting the appropriate Diodes products for their applications, (b) evaluating the suitability of Diodes' products for their intended applications, (c) ensuring their applications, which incorporate Diodes' products, comply the applicable legal and regulatory requirements as well as safety and functional-safety related standards, and (d) ensuring they design with appropriate safeguards (including testing, validation, quality control techniques, redundancy, malfunction prevention, and appropriate treatment for aging degradation) to minimize the risks associated with their applications.
3. Diodes assumes no liability for any application-related information, support, assistance or feedback that may be provided by Diodes from time to time. Any customer or user of this document or products described herein will assume all risks and liabilities associated with such use, and will hold Diodes and all companies whose products are represented herein or on Diodes' websites, harmless against all damages and liabilities.
4. Products described herein may be covered by one or more United States, international or foreign patents and pending patent applications. Product names and markings noted herein may also be covered by one or more United States, international or foreign trademarks and trademark applications. Diodes does not convey any license under any of its intellectual property rights or the rights of any third parties (including third parties whose products and services may be described in this document or on Diodes' website) under this document.
5. Diodes' products are provided subject to Diodes' Standard Terms and Conditions of Sale (<https://www.diodes.com/about/company/terms-and-conditions/terms-and-conditions-of-sales/>) or other applicable terms. This document does not alter or expand the applicable warranties provided by Diodes. Diodes does not warrant or accept any liability whatsoever in respect of any products purchased through unauthorized sales channel.
6. Diodes' products and technology may not be used for or incorporated into any products or systems whose manufacture, use or sale is prohibited under any applicable laws and regulations. Should customers or users use Diodes' products in contravention of any applicable laws or regulations, or for any unintended or unauthorized application, customers and users will (a) be solely responsible for any damages, losses or penalties arising in connection therewith or as a result thereof, and (b) indemnify and hold Diodes and its representatives and agents harmless against any and all claims, damages, expenses, and attorney fees arising out of, directly or indirectly, any claim relating to any noncompliance with the applicable laws and regulations, as well as any unintended or unauthorized application.
7. While efforts have been made to ensure the information contained in this document is accurate, complete and current, it may contain technical inaccuracies, omissions and typographical errors. Diodes does not warrant that information contained in this document is error-free and Diodes is under no obligation to update or otherwise correct this information. Notwithstanding the foregoing, Diodes reserves the right to make modifications, enhancements, improvements, corrections or other changes without further notice to this document and any product described herein. This document is written in English but may be translated into multiple languages for reference. Only the English version of this document is the final and determinative format released by Diodes.
8. Any unauthorized copying, modification, distribution, transmission, display or other use of this document (or any portion hereof) is prohibited. Diodes assumes no responsibility for any losses incurred by the customers or users or any third parties arising from any such unauthorized use.
9. This Notice may be periodically updated with the most recent version available at <https://www.diodes.com/about/company/terms-and-conditions/important-notice>

DIODES is a trademark of Diodes Incorporated in the United States and other countries.  
The Diodes logo is a registered trademark of Diodes Incorporated in the United States and other countries.  
© 2022 Diodes Incorporated. All Rights Reserved.

[www.diodes.com](http://www.diodes.com)