

## Description

Very cost effective design to meet international requirements. No exposed metal parts which are, or could become, current-carrying except for terminals. R-type TO CBE to EN 60934.

- Manual reset, cycling trip free mechanism
- Extremely small and lightweight
- UL, CSA, VDE and EN 60934 (IEC 60934) approved

## Typical applications

Battery chargers, consumer products, power supplies, motors.

## Ordering information

Type No.	
1658	single pole thermal circuit breaker
<b>Threadneck design</b>	
G21	manual reset type, 3/8"-27 threadneck
G41	manual reset type, 7/16"-28 threadneck
A21	auto reset type, 3/8"-27 threadneck
A41	auto reset type, 7/16"-28 threadneck
A00	auto reset type, without threadneck
F01	snap in
<b>Hardware</b>	
00	no hardware
01	one PAL nut, bulk
02	one PAL nut, one knurled nut, bulk
03	one PAL nut mounted
04	one PAL nut, one knurled nut, mounted
05	one PAL nut mounted, one knurled nut, bulk
06	one knurled nut, bulk
07	one hex nut, bulk
08	two hex nuts, bulk
<b>Terminals</b>	
P10	blade terminals A6.3-0.8 (QC .250)
P13	blade terminals A6.3-0.8 (QC .250), 90°
S80	straight screw terminals*
S83	90° bent screw terminals*
<b>Current ratings</b>	
5...30 A	
1658 - G21 - 02 - P10 - 5 A    Ordering example	

\* Screws and lock washers bulk shipped

## Standard current ratings and typical voltage drop values

Current rating (A)	Voltage drop (mV)	Current rating (A)	Voltage drop (mV)
5	≤ 250	12	≤ 250
6	≤ 250	15	≤ 250
7	≤ 250	16	≤ 250
8	≤ 250	20	≤ 250
9	≤ 250	25	≤ 250
10	≤ 250	30	≤ 250

## Approvals

Authority	Voltage rating	Current ratings
VDE (EN 60934)	AC 240 V; DC 28 V	5...25 A
UL	AC 240 V	5...16 A    1658-G../F..
	AC 120 V	18...30 A    1658-G../F..
	AC 120 V	5...30 A    1658-A...
	DC 32 V	5...30 A    1658-G../F..
	DC 28 V	5...30 A    1658-A..



## Technical data

For further details please see chapter: Technical Information

Voltage rating	AC 240 V; DC 28 V	
Current ratings	5...30 A	
Typical life	5...16 A	1,000 operations at 2 x I <sub>N</sub> , inductive
AC + DC	17...25 A	1,000 operations at 2 x I <sub>N</sub> , resistive
Ambient temperature	-20...+60 °C (-4...+140 °F), ≤ 7 A max. +40 °C (+104 °F)	
Insulation co-ordination (IEC 60664 and 60664 A)	rated impulse withstand voltage 2.5 kV	pollution degree 2 reinforced insulation in operating area
Dielectric strength (IEC 60664 and 60664 A) operating area	test voltage AC 3,000 V	
Insulation resistance	> 100 MΩ (DC 500 V)	
Interrupting capacity I <sub>cn</sub>	5...7 A	180 A
	8...30 A	200 A
Interrupting capacity (UL 1077/EN 60934 PC1)	I <sub>N</sub>	U <sub>N</sub>
	5...16 A	AC 240 V 2,000 A
	17...30 A	AC 120 V 2,000 A
	5...30 A	DC 32 V 2,500 A
	5...30 A	DC 28 V 2,000 A (1658-A..)
Degree of protection (IEC 60529/DIN 40050)	operating area IP40 terminal area IP00	
Vibration	8 g (57-500 Hz) ± 0.61 mm (10-57 Hz), to IEC 60068-2-6, test Fc, 10 frequency cycles/axis	
Shock	30 g (11 ms) to IEC 60068-2-27, test Ea	
Corrosion	96 hours at 5 % salt mist, to IEC 60068-2-11, test Ka	
Humidity	240 hours at 95 % RH to IEC 60068-2-78, test Cab	
Mass	approx. 16 g	

1

## Dimensions

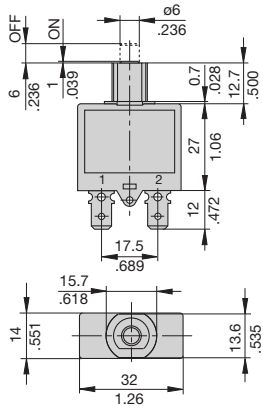

**A00**



**A21** tightening torque max. 0.8 Nm  
3/8-27UNS-2A

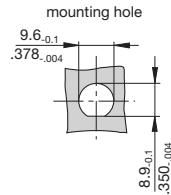
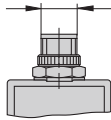

**G21** tightening torque max. 0.8 Nm  
3/8-27UNS-2A

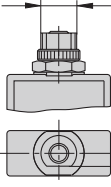

**A41**

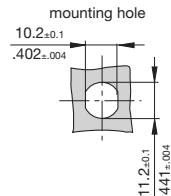
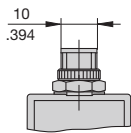

**G41** double "D"  
7/16-28UNS-2A  
tightening torque max. 0.8 Nm

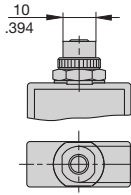

**F01**

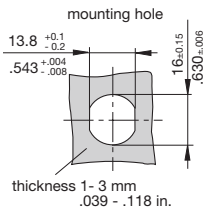
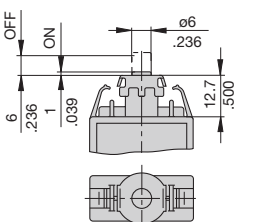

Caution:  
Please keep a tight grip on the unit  
while removing the female connectors.

See ordering information for mounting hardware.

## Terminal design

**P10**

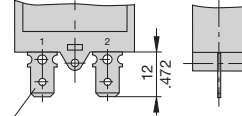

blade terminals DIN 46244-A6.3-0.8 (QC .250)

**S83**

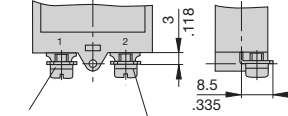

terminal screw 6-32 UNC  
lock washer

**P13**

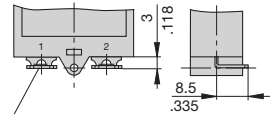

blade terminals DIN 46244-A6.3-0.8 (QC .250)  
angled 90°

**P10-S83**

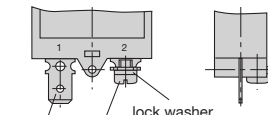

terminal screw 6-32 UNC  
lock washer

**S80**

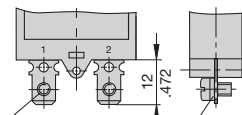

terminal screw 6-32 UNC  
lock washer

blade terminals DIN 46244-A6.3-0.8 (QC .250)

## Installation drawing

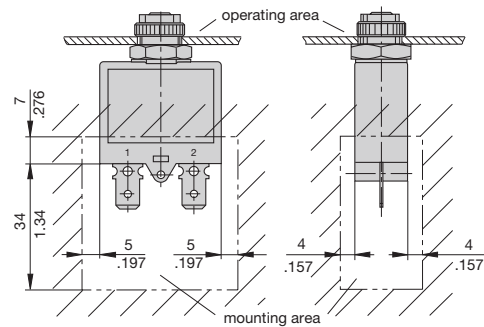

This is a metric design and millimeter dimensions take precedence ( $\frac{mm}{inch}$ )

## Internal connection diagram

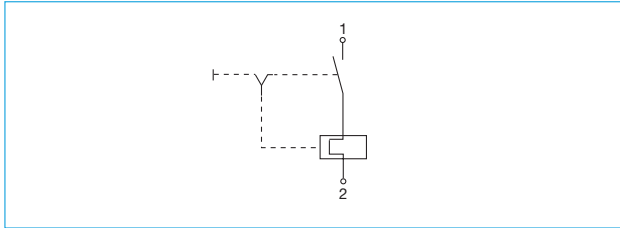

## Typical time/current characteristics

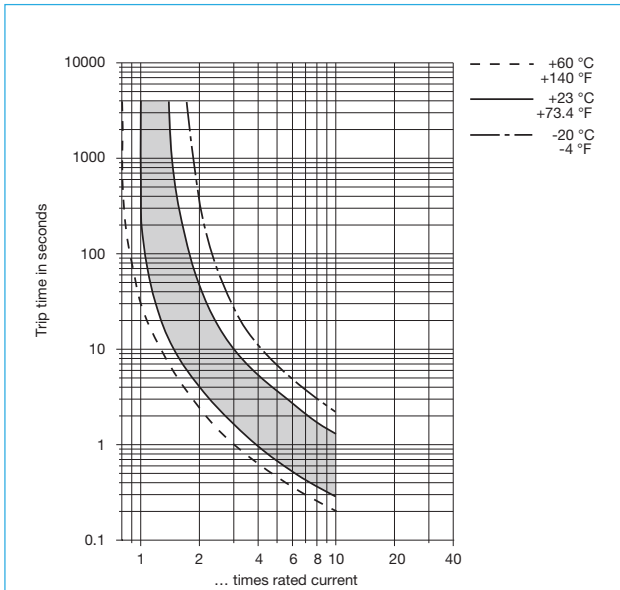

The time/current characteristic curve depends on the ambient temperature prevailing. In order to eliminate nuisance tripping, please multiply the circuit breaker current ratings by the derating factor shown below. See also section Technical information.

Ambient temperature °F	-4	+14	+32	+73.4	+104	+122	+140
°C	-20	-10	0	+23	+40	+50	+60
Derating factor $I_N > 7A$	0.83	0.85	0.9	1	1.1	1.18	1.25
$I_N \leq 7A$	0.74	0.76	0.82	1	1.23	-	-

## Accessories

Mounting nut 3/8", 27-thread  
Y 306 671 01

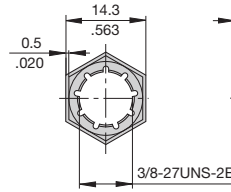

Mounting nut 7/16", 28-thread  
Y 303 200 01

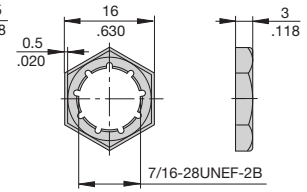

Knurled nut 3/8", 27-thread  
plastic (standard)  
Y 307 117 02

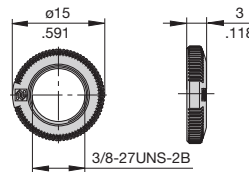

Knurled nut 7/16", 28-thread  
nickel-plated brass  
Y 302 294 03

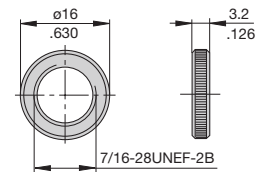

Knurled nut 3/8", 27-thread  
nickel-plated brass  
Y 300 190 03

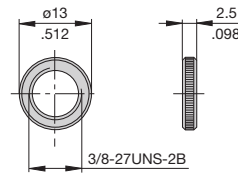

Hex nut 3/8", 27-thread  
nickel-plated brass  
Y 300 192 01

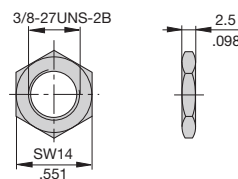

Hex nut 7/16", 28-thread  
nickel-plated brass  
Y 302 295 01

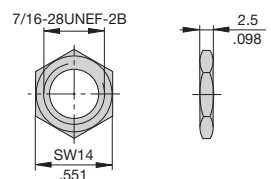

Press to Reset Plate for 3/8"  
thread, aluminium  
Y 301 059 02

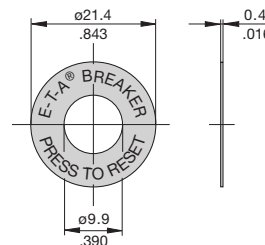

Press to Reset Plate for 7/16"  
thread, aluminium  
Y 302 732 01

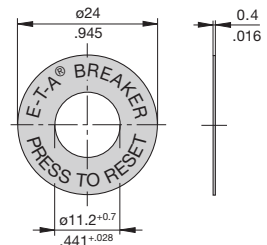

This is a metric design and millimeter dimensions take precedence ( $\frac{mm}{inch}$ )

**Accessories**

**1**

**Reset button seal for 3/8", 27-thread,  
short  
X 201 285 01**

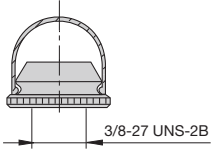

**long  
X 200 799 01**

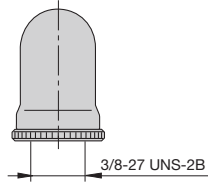

**Reset button seal for 7/16", 28-thread,  
short  
X 222 119 01**

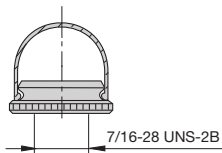

**long  
X 222 119 02**

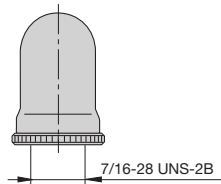

All dimensions without tolerances are for reference only. In the interest of improved design, performance and cost effectiveness the right to make changes in these specifications without notice is reserved. Product markings may not be exactly as the ordering codes. Errors and omissions excepted.