

PART NO.	COLOR	CIRCUIT SIZE	DIM A
212516-1001	NATURAL	1	10.50
212516-1002		2	10.50
212516-1003		3	13.58
212516-1004		4	17.78
212516-1005		5	21.98
212516-1006		6	26.18

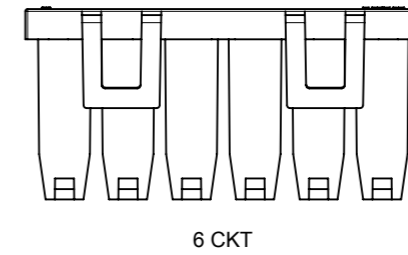
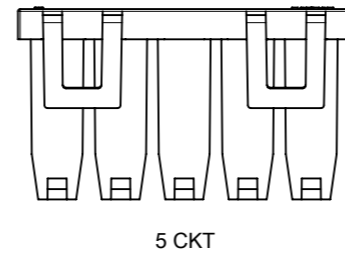
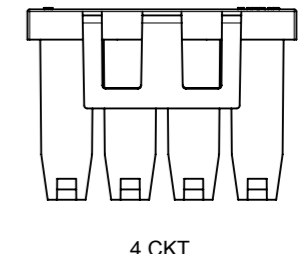
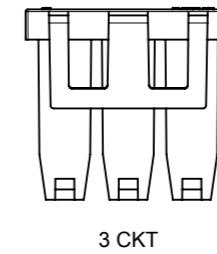
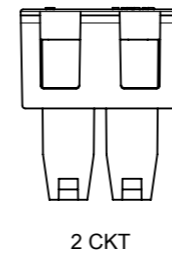
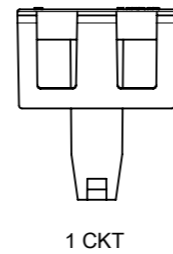
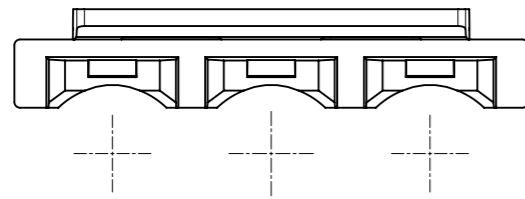
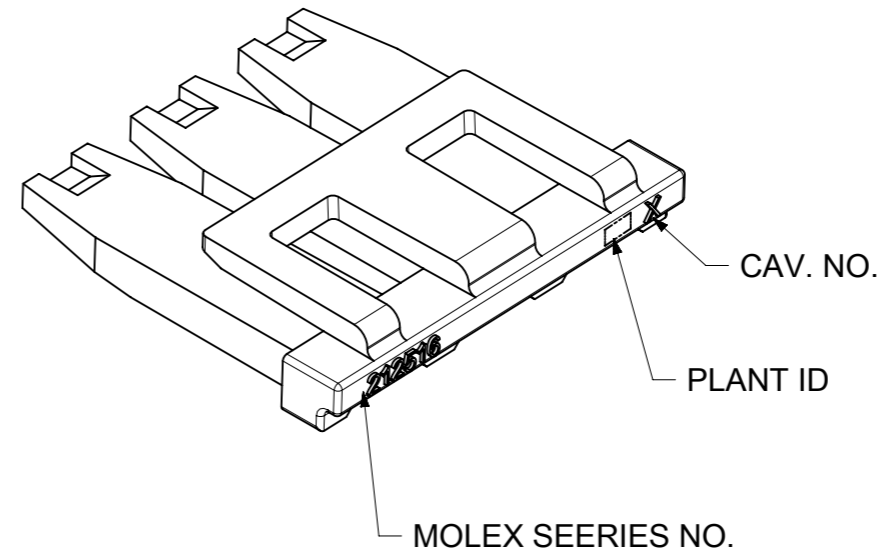
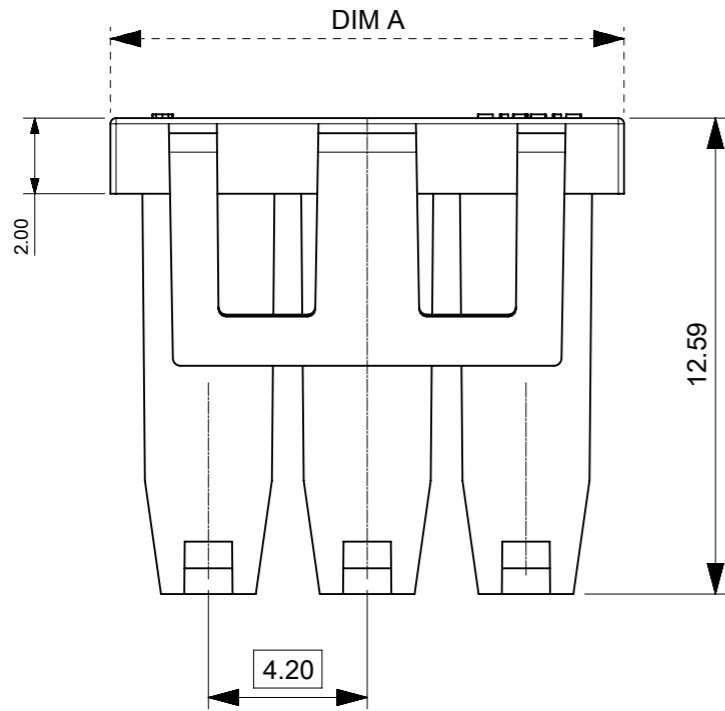

- NOTES:
1. MATERIAL: NYLON, NATURAL, UL 94-V0.
 2. PARTS TO BE PACKAGED PER 2125160001-PK.
 3. PRODUCT SPECIFICATION PER 2125150001-PS.
 4. PART USED WITH MOLEX RECEPTACLE HOUSING SERIES 212514.
 5. PARTS CONFORM TO CLASS "B" REQUIREMENTS OF COSMETIC SPECIFICATION PS-45499-002.
 6. APPLICATION SPECIFICATION: 2125150001-AS.
 7. MOLEX RECOMMENDS USING A NATURAL COLOR TPA FOR BLACK COLOR HOUSING AND A BLACK COLORED TPA FOR NATURAL COLORES HOUSINGS TO AID INSPECTION AFTER ASSEMBLY.

FUNCTIONAL SYMBOLS	THIS DRAWING CONTAINS INFORMATION THAT IS PROPRIETARY TO MOLEX ELECTRONIC TECHNOLOGIES, LLC AND SHOULD NOT BE USED WITHOUT WRITTEN PERMISSION						
	$\nabla_A = 0$ $\nabla_F = 0$ $\nabla_V = 0$	DIMENSION UNITS: mm SCALE: 5:1					CURRENT REV DESC: EC NO: 663331 DRWN: YXZHENG CHK'D: YXZHENG APPR: YXZHENG
DIVISIONAL SYMBOLS	GENERAL TOLERANCES (UNLESS SPECIFIED)		PRODUCT CUSTOMER DRAWING				
	ANGULAR TOL ± ° 4 PLACES ± 3 PLACES ± 2 PLACES ± 0.25 1 PLACE ± 0.5 0 PLACES ±	INITIAL REVISION: DRWN: SCHEN76 APPR: YXZHENG	2020/04/24 2020/05/13	DOCUMENT NUMBER 2125160001-SD	DOC TYPE PSD	DOC PART 000	REVISION B
DRAFT WHERE APPLICABLE MUST REMAIN WITHIN DIMENSIONS		THIRD ANGLE PROJECTION	DRAWING	SERIES	MATERIAL NUMBER	CUSTOMER	SHEET NUMBER
			A3-SIZE	212516	SEE TABLE		1 OF 1