

Fast Switching SCR T707__30

**300A Avg.
(475 RMS)
Up to 1400 Volts
25-60 μ s**

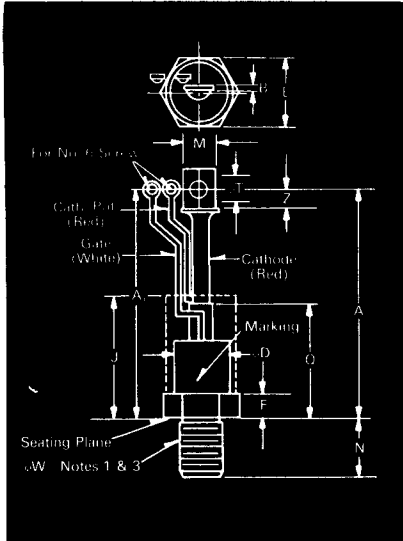

Symbol	Inches		Millimeters	
	Min.	Max.	Min.	Max.
A	9.76	10.00	247.90	254.00
A ₁	10.18	10.42	258.57	264.67
B	.063	.172	1.60	4.37
ϕ D		1.490		37.85
E	1.620	1.750	41.15	44.45
F	.430	.810	10.92	20.57
J	4.000		101.60	
M	.530	.755	13.46	19.18
N	1.04	1.08	26.42	27.43
Q		3.100		78.74
ϕ T	.330	.350	8.38	8.89
Z	.440		11.18	
ϕ W	¼-16 UNF-2A			

Creep Distance—1.76 in. min. (44.91 mm).
Strike Distance—.81 in. min. (20.70 mm).
(In accordance with NEMA standards.)

Finish—Nickel Plate.

Approx. Weight—16 oz. (454 g).

1. Complete threads to extend to within 2½ threads of seating plane.
2. Angular orientation of terminals is undefined.
3. Pitch diameter of ¼-16 UNF-2A (coated) threads (ASA B1.1-1960).
4. Dimension "J" denotes seated height with leads bent at right angles.

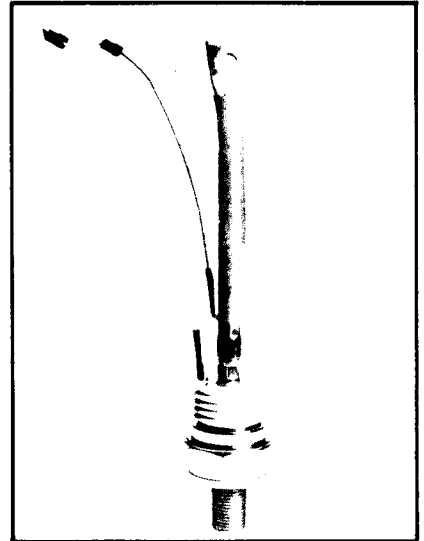

T70 Outline

Features:

- Center fired di/damic gate
- High di/dt with soft gate control
- High frequency operation
- Sinusoidal waveform operation to 20 KHz
- Rectangular waveform operation to 20 KHz
- Low dynamic forward voltage drop
- Low switching losses at high frequency
- Westinghouse Lifetime Guarantee

Applications:

- Inverters for UPS
- Induction heating
- AC motor drives
- Cycloconverters
- Choppers
- Crowbar

Ordering Information

Type	Voltage		Current		Turn-off		Gate Current		Leads	
Code	V _{DRM} and V _{RRM} (V)	Code	I _{T(av)} (A)	Code	t _q μ sec	Code	I _{GT} (ma)	Code	Case	Code
T707	100	01	300	30	25	4	150	4	T70	BY
	200	02								
	300	03								
	400	04								
	500	05								
	600	06								
	700	07								
	800	08								
	900	09								
	1000	10								
	1100	11								
	1200	12								
	1400	14								

Example

Obtain optimum device performance for your application by selecting proper Order Code.

Type T 707 rated at 300A average with V_{DRM} = 800V. I_{GT} = 150 ma, t_q = 40 μ sec and standard flex lead — order as

Type	Voltage	Current	Turn Off	Gate Current	Leads
T 7 0 7	0 8	3 0	4	4	B Y

FAST SWITCHING THYRISTORS

300A Avg. (475 RMS) Up to 1400 Volts 25-60 μ s

Fast Switching SCR T707_30

Voltage

Blocking State Maximums^① ($T_J = 125^\circ\text{C}$)

	Symbol
Repetitive peak forward blocking voltage, V	V_{DRM}
Repetitive peak reverse voltage, V	V_{RRM}
Non-repetitive transient peak reverse voltage, V $t \leq 5.0$ msec	V_{RSM}
Forward leakage current, mA peak	I_{DRM}
Reverse leakage current, mA peak	I_{RRM}

100	200	300	400	500	600	700	800	900	1000	1100	1200	1400
100	200	300	400	500	600	700	800	900	1000	1100	1200	1400
200	300	400	500	600	700	800	900	1000	1100	1200	1300	1500
←							30		→			
←							30		→			

Current

Conducting State Maximums
($T_J = 125^\circ\text{C}$)

	Symbol	T707_30
RMS forward current, A	$I_T(\text{rms})$	475
Ave. forward current, A	$I_T(\text{av})$	300
One-half cycle surge current ^② , A	I_{TSM}	8000
I^2t for fusing (for times ≥ 8.3 ms) A ² sec.	I^2t_f	265,000
Forward voltage drop at $I_{TM} = 625$ A and $T_J = 25^\circ\text{C}$, V	V_{TM}	1.45
Min. repetitive di/dt , A/ μ sec	di/dt	400

Switching

($T_J = 25^\circ\text{C}$)

	Symbol	
Max. turn-off time, $I_T = 400$ A, $T_J = 125^\circ\text{C}$, $di/dt = 25$ A/ μ sec, reapplied $dv/dt =$ 20V/ μ sec. linear to .8V DRM, μ sec ^{③④}	t_q	25 to 60
Typ. turn-on-time, $I_T = 1000$ A, $V_D = 300$ V, μ sec	t_{on}	3.0
Min. critical dv/dt , exponential to V_{DRM} , $T_J = 125^\circ\text{C}$, V/ μ sec ^{⑤⑥}	dv/dt	300
Min. di/dt , non-repetitive, μ sec ^{⑦⑧⑨}	di/dt	800

Gate

Maximum Parameters
($T_J = 25^\circ\text{C}$)

	Symbol	
Gate current to trigger at $V_D = 12$ V, mA	I_{GT}	150
Gate voltage to trigger at $V_D = 12$ V, V	V_{GT}	3
Non-triggering gate voltage, $T_J = 125^\circ\text{C}$, and rated V_{DRM} , V	V_{GDM}	0.15
Peak forward gate current, A	I_{GTM}	4
Peak reverse gate voltage, V	V_{GRM}	5
Peak gate power, Watts	P_{GM}	16
Average gate power, Watts	$P_{G(av)}$	3

Thermal and Mechanical

	Symbol	
Min., Max. oper. junction temp., $^\circ\text{C}$	T_J	-40 to +125
Min., Max. storage temp., $^\circ\text{C}$	T_{stg}	-40 to +15C
Max. mounting torque, in lb		360
Max. Thermal resistance ^⑩		
Junction to case, $^\circ\text{C}/\text{Watt}$	$R_{\theta JC}$.10
Case to sink, lubricated, $^\circ\text{C}/\text{Watt}$	$R_{\theta CS}$.05

- ① Consult recommended mounting procedures.
- ② Applies for zero or negative gate bias.
- ③ Per JEDEC RS-397, 5.2.2.1.
- ④ With recommended gate drive.
- ⑤ Higher dv/dt ratings available, consult factory.
- ⑥ Per JEDEC standard RS-397, 5.2.2.6.
- ⑦ For operation with antiparallel diode, consult factory.

Maximum Forward Voltage Drop, Vs. Forward Current

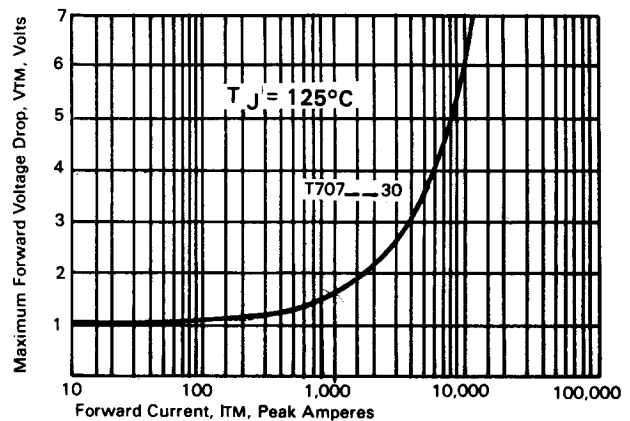

DC Transient Thermal Impedance VS. Time

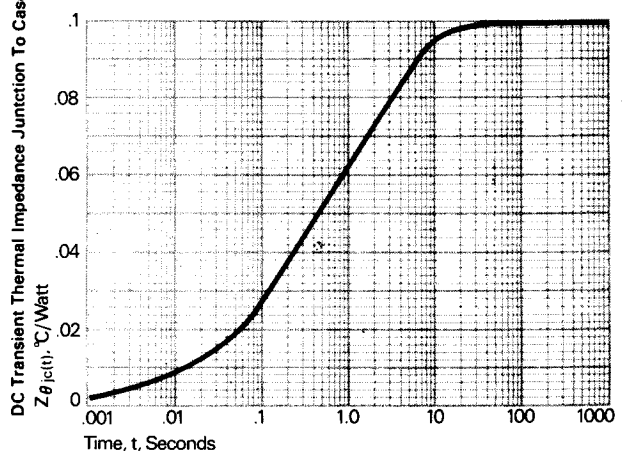

Fast Switching SCR T707_30

300A Avg.
(475 RMS)
Up to 1400 Volts
25-60 μ s

Sinusoidal Current Data

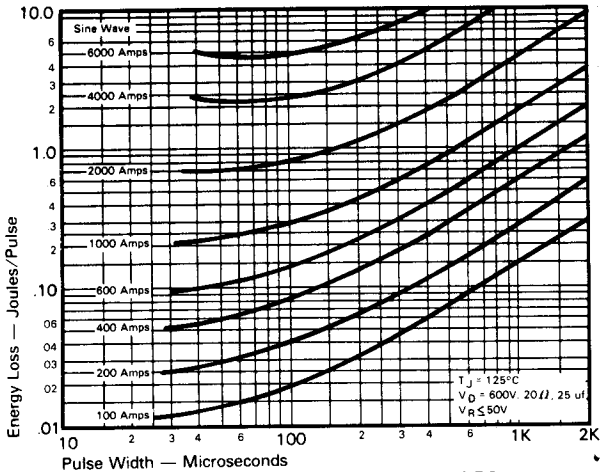

ENERGY PER PULSE FOR SINUSOIDAL PULSES

Trapezoidal Wave Current Data

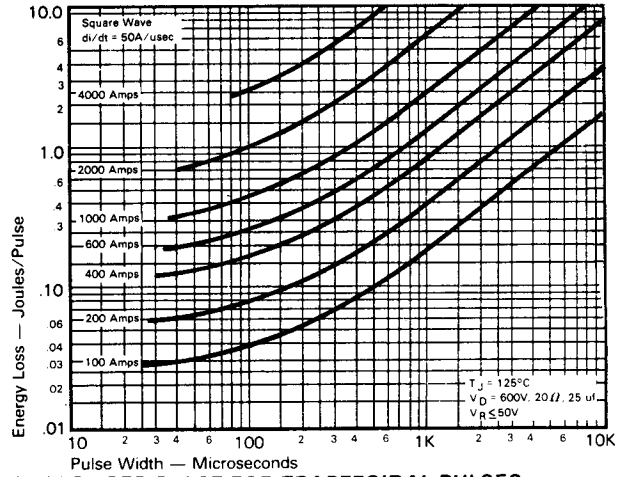

ENERGY PER PULSE FOR TRAPEZOIDAL PULSES
($di/dt = 50\text{A/usec}$)

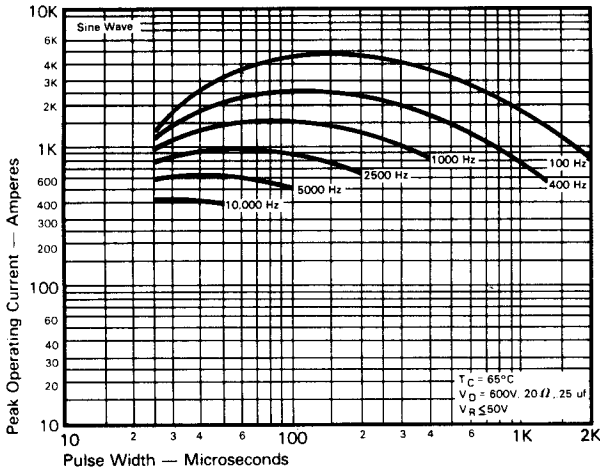

MAXIMUM ALLOWABLE PEAK ON-STATE CURRENT
vs. PULSE WIDTH ($T_C = 65^\circ\text{C}$)

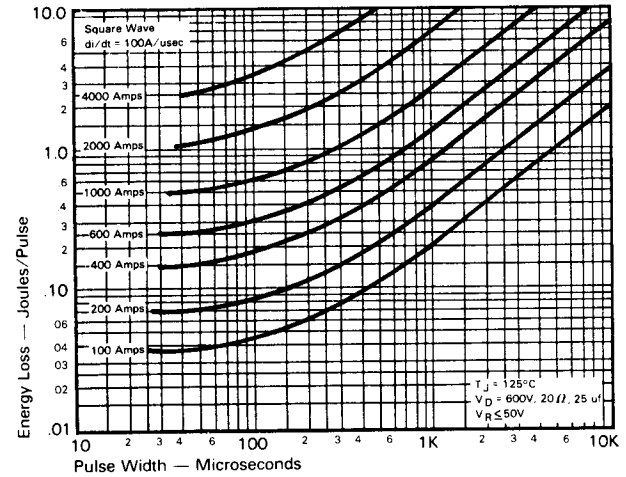

ENERGY PER PULSE FOR TRAPEZOIDAL PULSES
($di/dt = 100\text{A/usec}$)

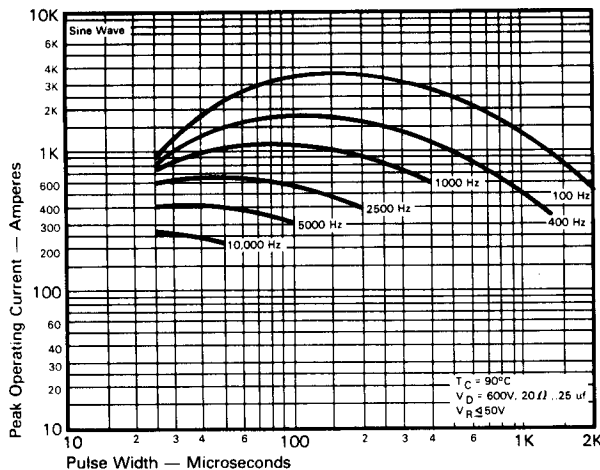

MAXIMUM ALLOWABLE PEAK ON-STATE CURRENT
vs. PULSE WIDTH ($T_C = 90^\circ\text{C}$)

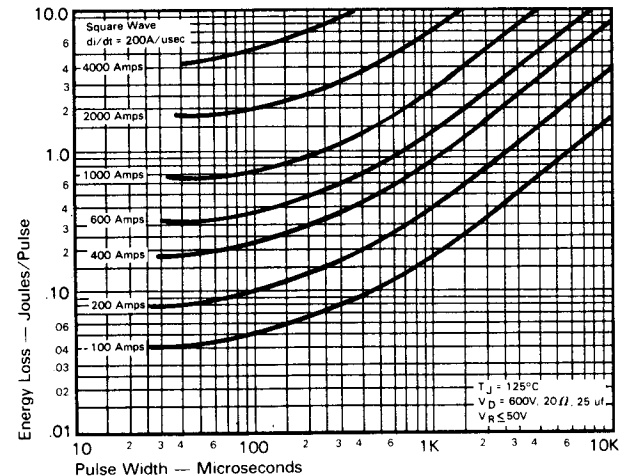

ENERGY PER PULSE FOR TRAPEZOIDAL PULSES
($di/dt = 200\text{A/usec}$)

FAST SWITCHING
THYRISTORS

**300A Avg.
(475 RMS)
Up to 1400 Volts
25-60 μ s**

**Fast Switching
SCR
T707_30**

**Trapezoidal Wave Current Data
($T_C = 65^\circ\text{C}$)**

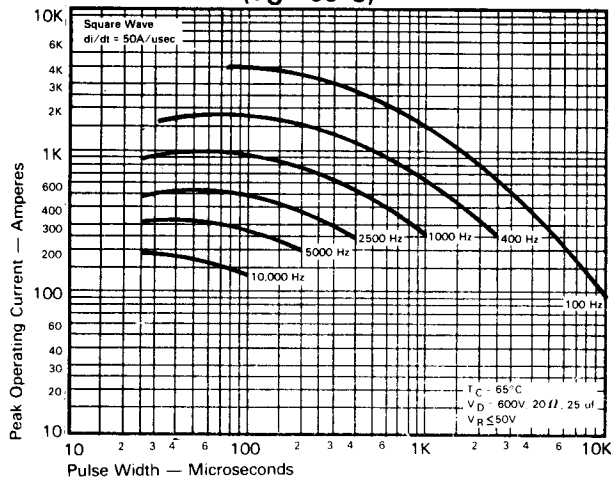

MAXIMUM ALLOWABLE PEAK ON-STATE CURRENT vs. PULSE WIDTH ($di/dt = 50A/usec$)

**Trapezoidal Wave Current Data
($T_C = 90^\circ\text{C}$)**

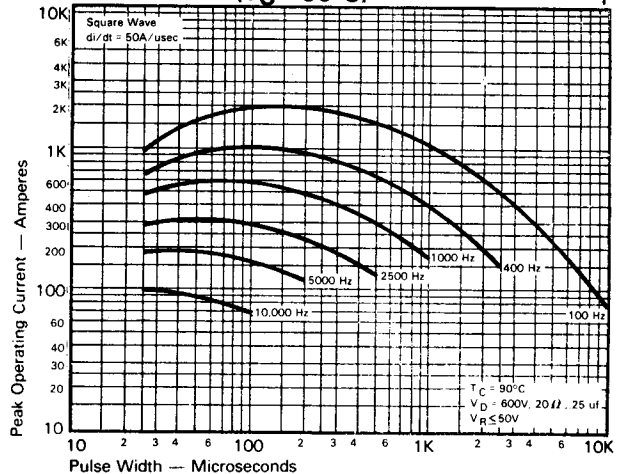

MAXIMUM ALLOWABLE PEAK ON-STATE CURRENT vs. PULSE WIDTH ($di/dt = 50A/usec$)

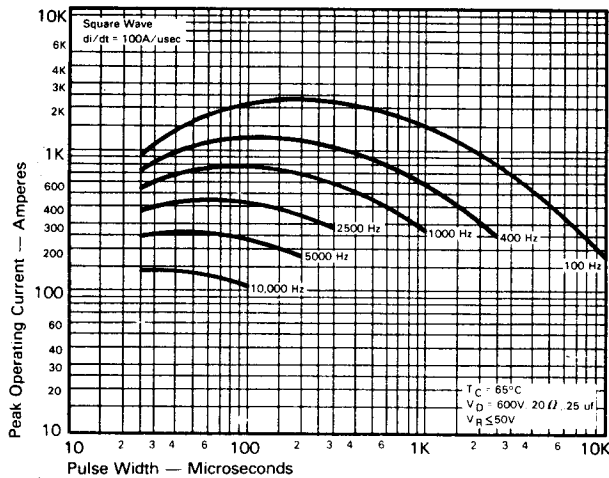

MAXIMUM ALLOWABLE PEAK ON-STATE CURRENT vs. PULSE WIDTH ($di/dt = 100A/usec$)

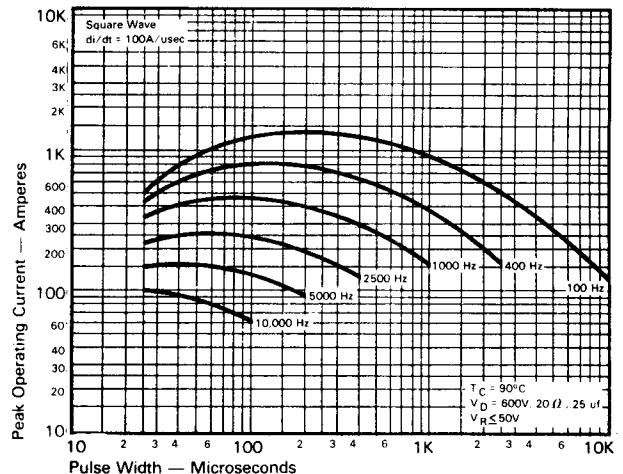

MAXIMUM ALLOWABLE PEAK ON-STATE CURRENT vs. PULSE WIDTH ($di/dt = 100A/usec$)

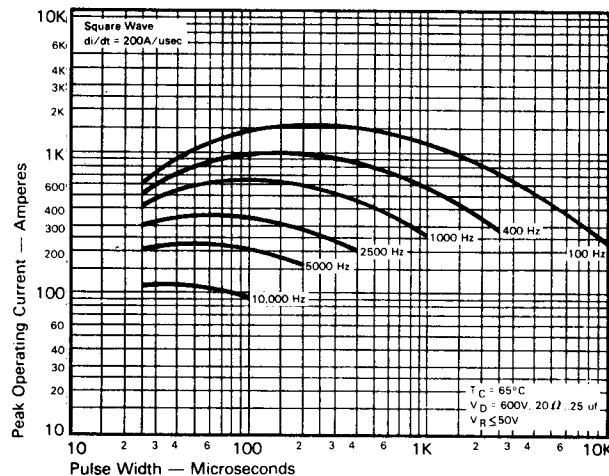

MAXIMUM ALLOWABLE PEAK ON-STATE CURRENT vs. PULSE WIDTH ($di/dt = 200A/usec$)

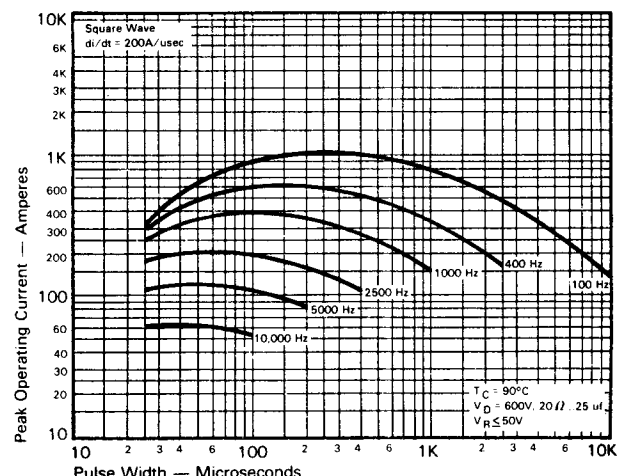

MAXIMUM ALLOWABLE PEAK ON-STATE CURRENT vs. PULSE WIDTH ($di/dt = 200A/usec$)

FAST SWITCHING THYRISTORS

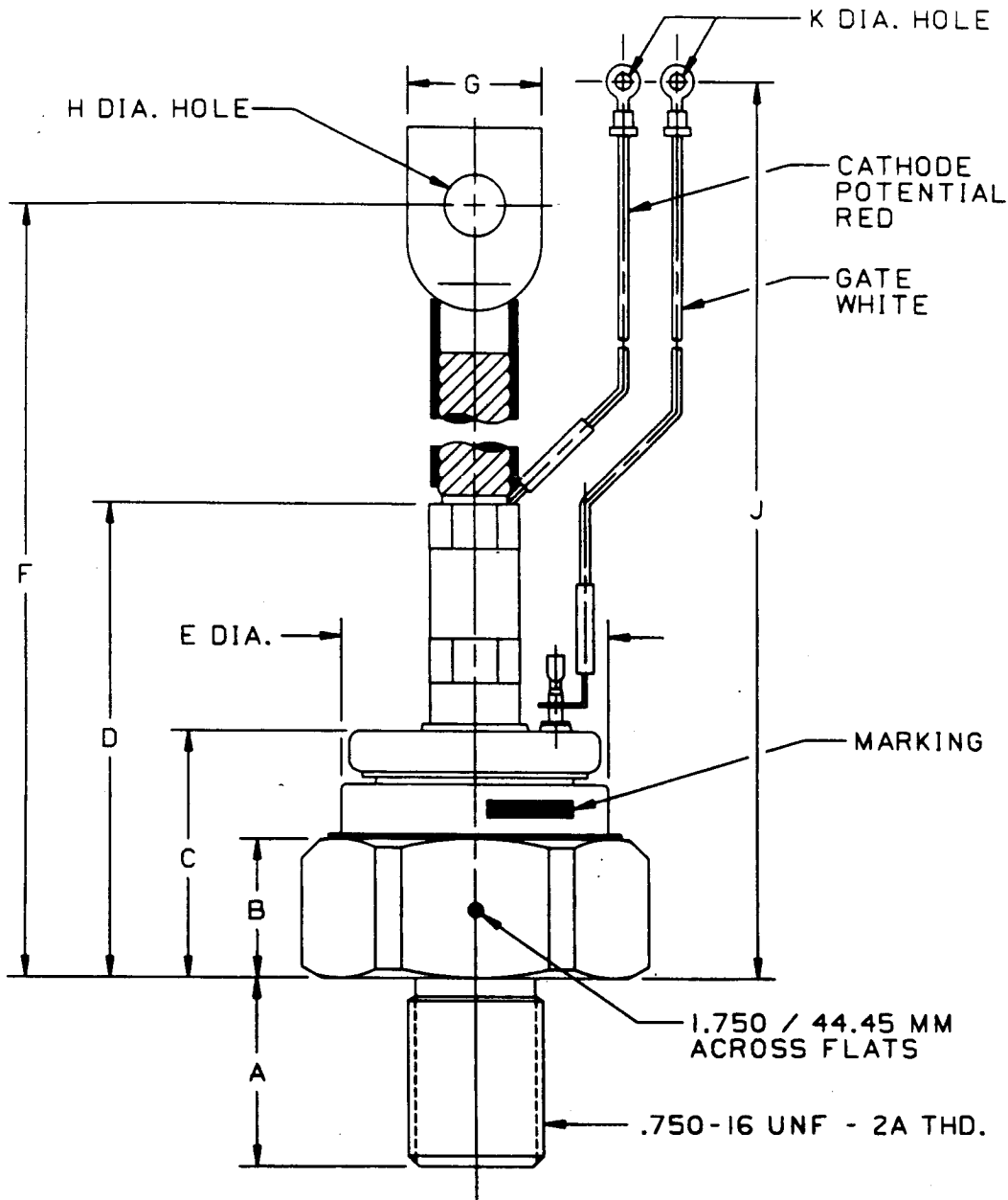

CASE NUMBER T70
 NOMINAL DIMENSIONS

STRIKE DISTANCE = .43 INCH / 10.9 MM MIN.
 CREEPAGE DISTANCE = .43 INCH / 10.9 MM MIN.

SYM.	A	B	C	D	E	F	G	H	J	K
INCHES	1.06	.78	1.41	2.74	1.49	9.66	.73	.343	10.06	.146
MM	26.9	19.8	35.8	69.6	37.8	245.4	18.5	8.71	255.5	3.71

ALL DIMENSIONS ARE REFERENCE