

# TLE4966 MS2GO

Quick Start

V1.0.0



# Document Contents

1

Description

2

Content

3

Use-Cases

4

Hardware description & design

5

Software Installation Process

6

Software features

# Agenda

1

Description

2

Content

3

Use-Cases

4

Hardware description & design

5

Software Installation Process

6

Software features

# Description

- > The TLI4966 MS2GO Evaluationkit is a budgetary priced kit that is enabling the evaluation of the TLE4966G lateral Hall latch and TLE4966V-1G vertical Hall latch.
- > The TLE4966 MS2GO Evaluation kit is offered in one version combining both sensors above mentioned.



# General Sensor Description

- › The TLE4966G and the TLE4966V-1G are integrated circuit double Hall-effect sensor designed specifically for highly accurate applications. Precise magnetic switching points and high temperature stability are achieved by active compensation circuits and chopper techniques on chip. They provide a speed signal at Q2 for every magnetic pole pair and a direction information at Q1, which is provided before the speed signal.

TLE4966V-1G

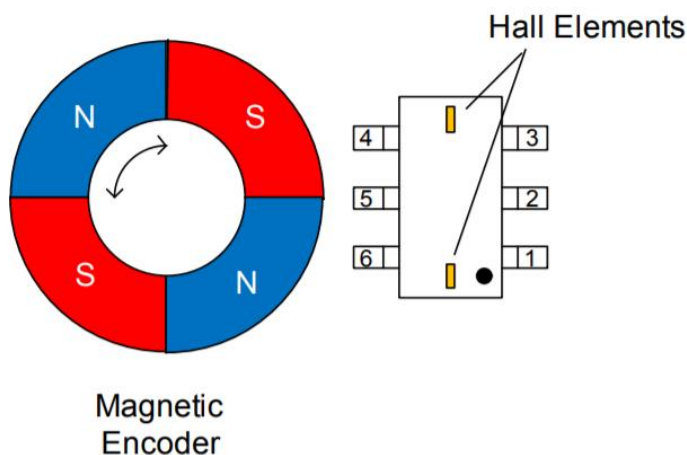

TLE4966G

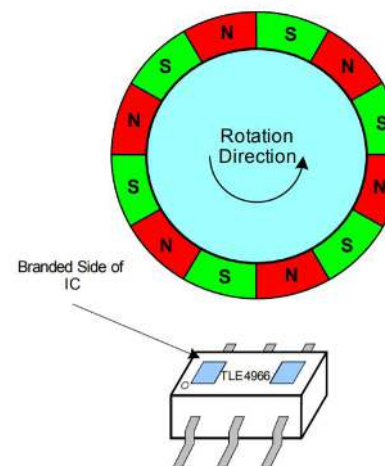

# Agenda

1

Description

2

Content

3

Use-Cases

4

Hardware description & design

5

Software Installation Process

6

Software features

# Content – TLE4966 MS2GO

## > TLE4966 MS2GO content:

- Evaluation board equipped with XMC1100 as target microcontroller, XMC4200 as debugger microcontroller, TLE4966G, TLE4966V-1G, TLI493D-W2BW as magnetic probe, auxiliary circuitry.
- Ferrite block magnet FE-Q-07-07-05 for easy magnetic basic evaluation.
- Paper container box



# Content – Optional Mechanics

- › TLE4966 MS2GO was designed to be compatible mechanical-wise with Infineon Out-Of-Shaft 3D sensor control. The Out-Of-Shaft 3D sensor control is not included in the evaluation kit content, therefore has to be ordered separately.
- › The Out-Of-Shaft 3D sensor control ordering code: SP003475178

PL	Type	SP No	Package	NDA Reqd	EC CN	AL NR	MY class	SI class	ECCN US	PCN No	Sort	Description	Rohs2002	SAP Plant	MRQ	FOC Qty	Disti FOC QTY	Disti-Visible	Price EUR
42	OUT OF SHAFT FOR 3D 2 GO	SP003475178		No	N_	N	N	N	EAR99		TOBO	OUT OF SHAFT FOR 3D 2 GO; LT 1-6 weeks after ordering	N	WRS0	10	1	1	Yes	2000.00

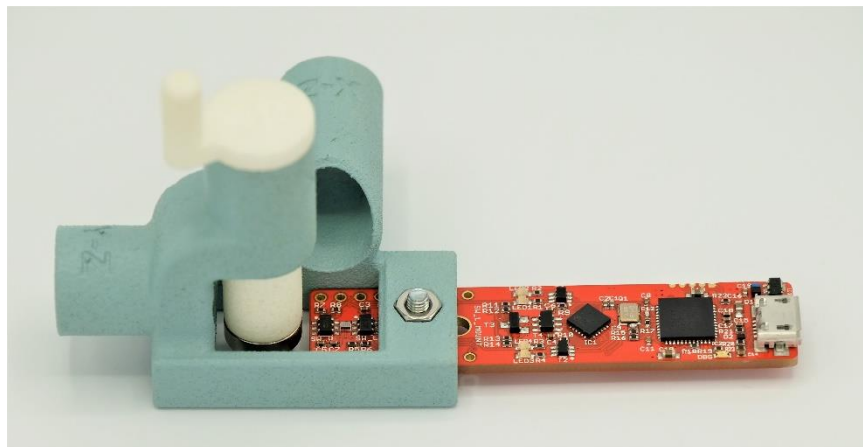



# Agenda

1

Description

2

Content

3

Use-Cases

4

Hardware description & design

5

Software Installation Process

6

Software features

# Use case 1: TLE4966 MS2GO–vertical placement

- This use-case highlights the vertical Hall technology used in TLE4966V-1G sensor.
- The magnet placement for this application is highlighted using as example the Out-Of-Shaft 3D Sensor control.

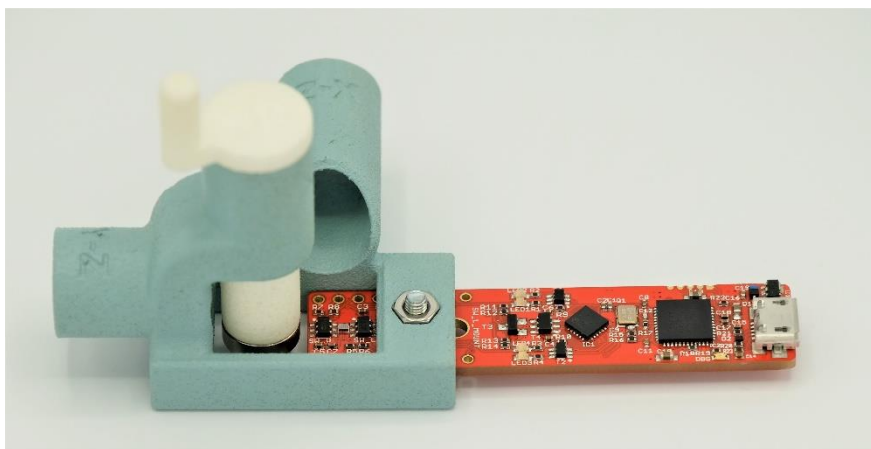

# Use case 2: TLE4966 MS2GO–lateral placement

- This use-case highlights the lateral Hall technology used in TLE4966G sensor.
- The magnet placement for this application is highlighted using as example the Out-Of-Shaft 3D Sensor control.

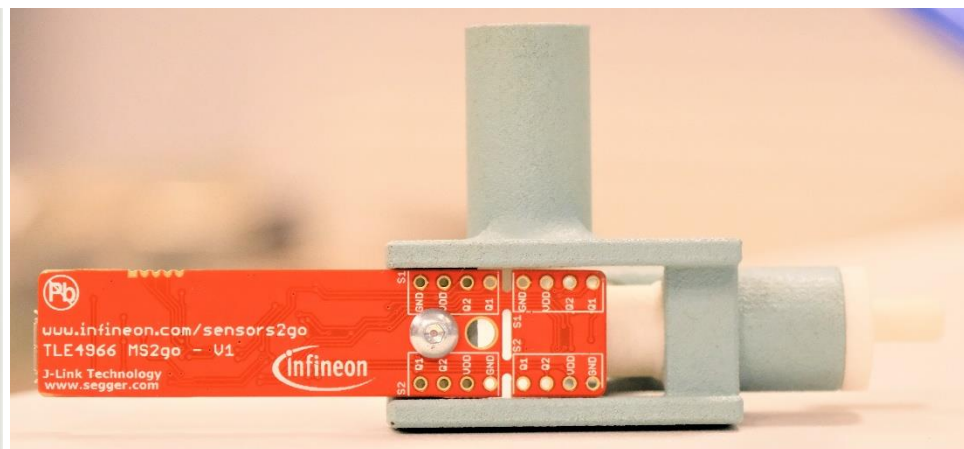
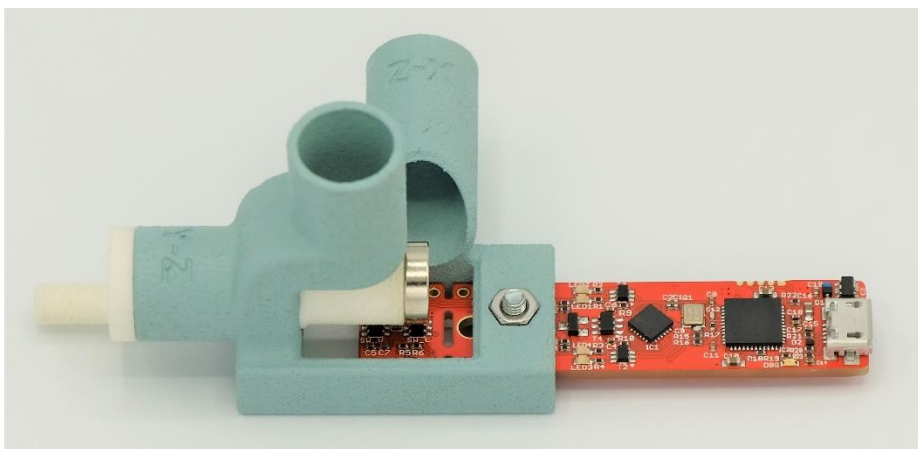

# Use case 3: standalone sensor evaluation

- In this use case, the user may disconnect the sensor PCB (by cutting the PCB across the milled line) and electrically connect it remotely to the remaining PCB or to his own electrical setup.
- In this use-case, the user loses connectivity to the 3D Sensor magnetic probe.
- The side pin-header slots are directly connected to sensor outputs

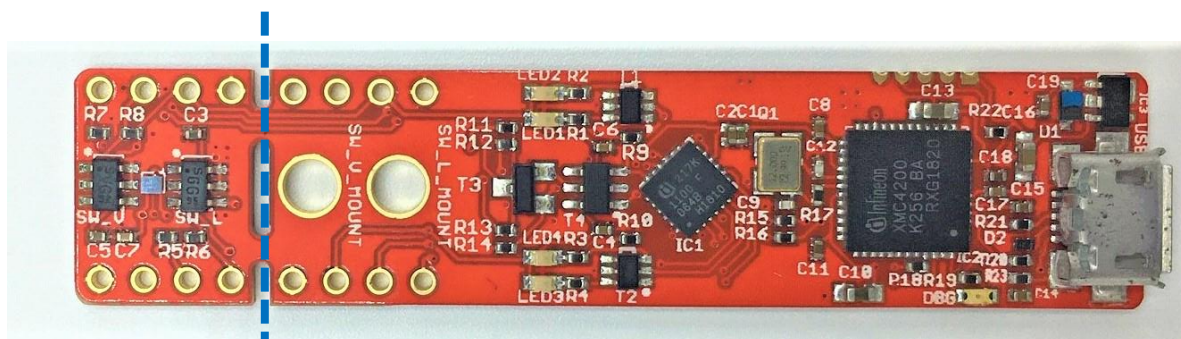

Cut across this line

# Agenda

1

Description

2

Content

3

Use-Cases

4

Hardware description & design

5

Software Installation Process

6

Software features

# Pinout Description

## The TLE4966 Hall Switch MS2Go



- The XMC pins P0.7 and P0.5 connect to the physical pins 2 and 12 via PMOS transistors
- Ground pins on board connected with each other.
- The maximum voltage on the pins is 3.6V

- Pins connected to the on-board magnetic field probe TLI493D-W2BW

P0.15	5	PROBE ON
P2.10	11	PROBE SDA
P2.11	10	PROBE SCL
P0.0	9	PROBE /INT
GND		PROBE GND

### Legend

	Information
	Labelling of Pins in Datasheet
	Pin Number in Arduino
	Physical Pin Number
	Warning
	Additional Information
	Not Connected

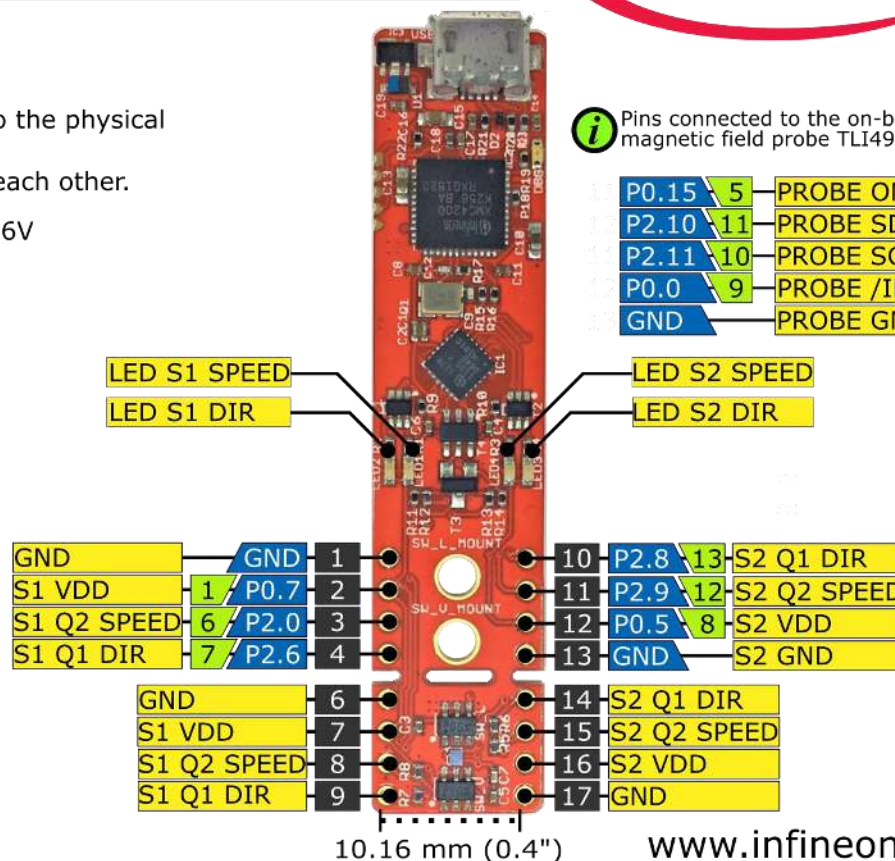

www.infineon.com

V1.0.0

# Hardware Description

- › The TLE4966 MS2GO Evaluation Kit can be connected directly to a PC via the micro-USB port (1).
- › The TLE4966 MS2GO evaluation kit board consists of:
  - One XMC4200 microcontroller running a SEGGER Jlink license for debugging (2)
  - One XMC1100 microcontroller used as target MCU (3)
  - 2x dual NMOS transistors (4) used for switching on/off LEDs. The transistors are used to buffer the outputs of the sensors and are not controlled by MCU.
  - Two BSL308PE dual package PMOS transistors (5) used for powering up the TLE4966G (10) and TLE4966V-1G (12) sensors
  - One PMOS BSS84P (6) used to power up the 3D sensor magnetic probe TLI493D W2BW (11)
  - 4 x LEDs for checking visually the sensor output states (7)
  - Mounting hole for lateral placement use-case (8)
  - Mounting hole for vertical placement use-case (9)

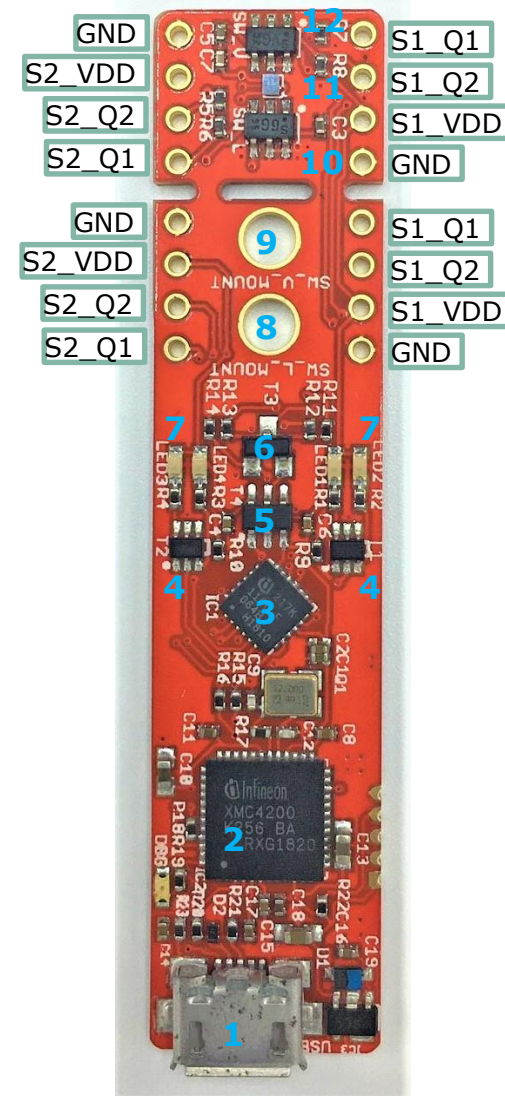

# Hardware design- schematic overview (1/2)

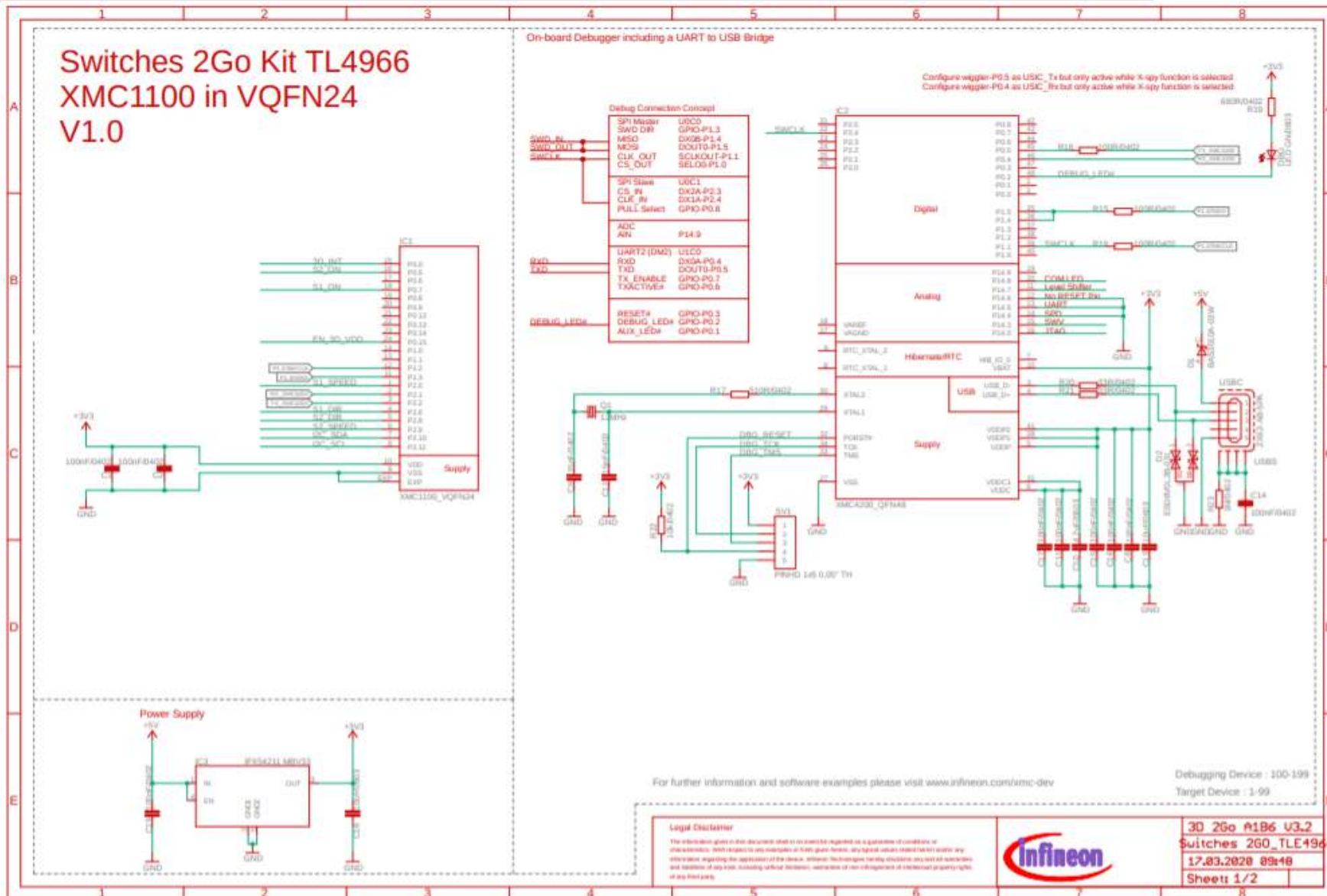



# Hardware design – schematic overview (2/2)

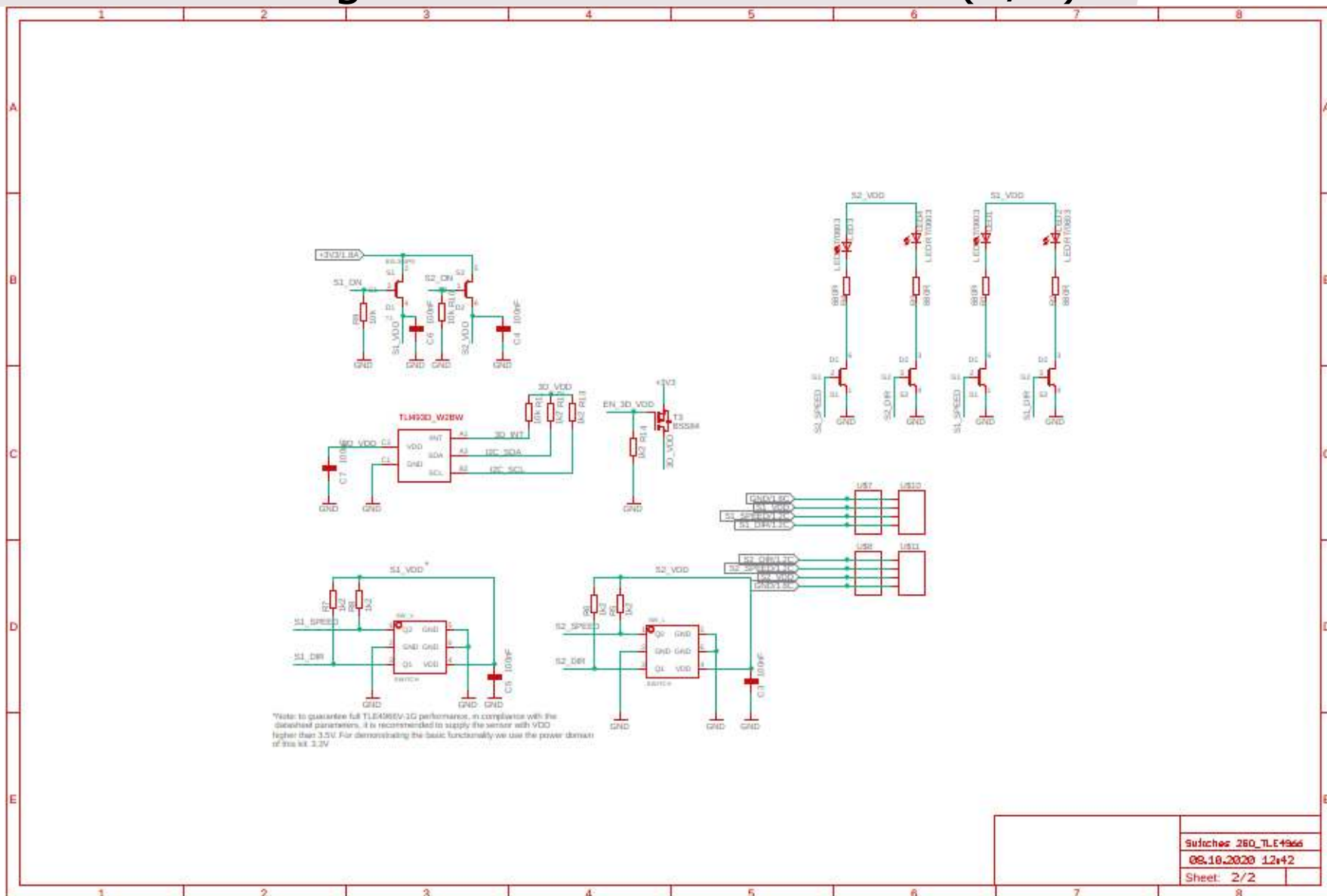

Switches\_260\_TLE4962

08\_10\_2020 12x42

Sheet: 2/2

# Detailed schematic: Power supply

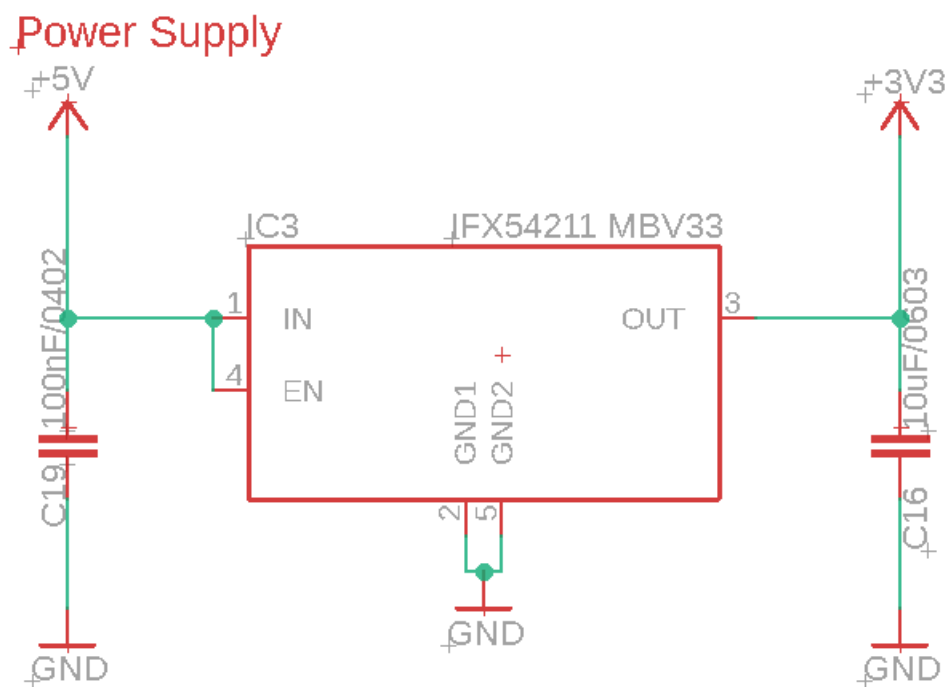

# Detailed schematic: On-board Debugger

On-board Debugger including a UART to USB Bridge

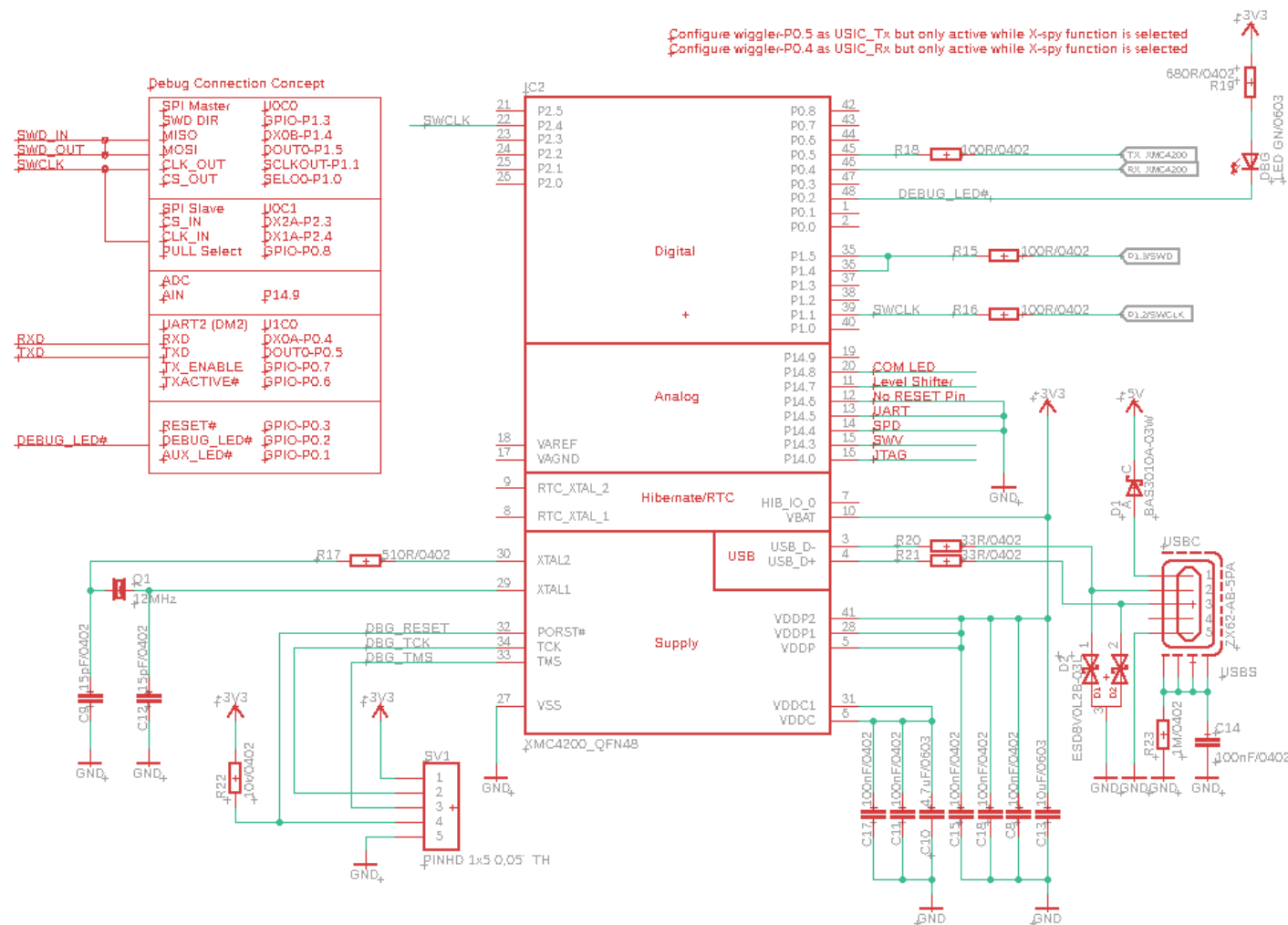

# Detailed schematic: XMC1100 pins

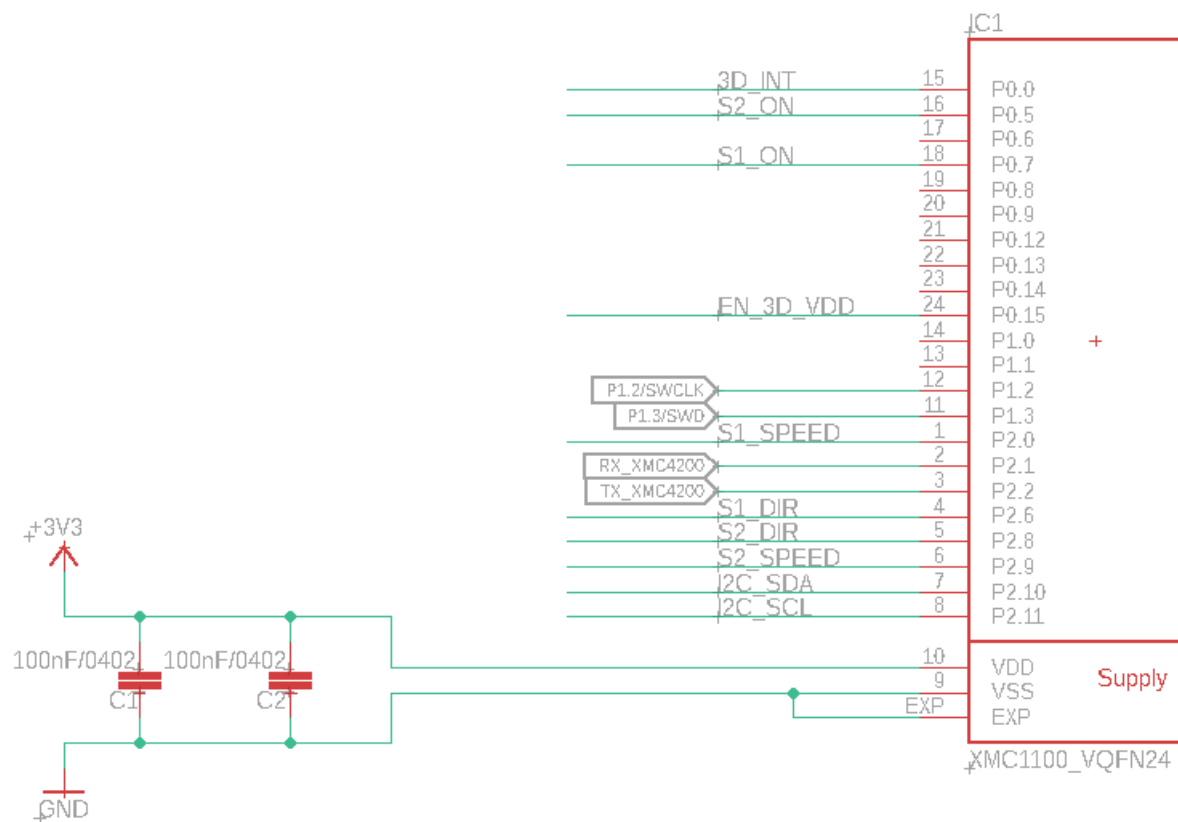

# Detailed schematic: Probe and PMOS

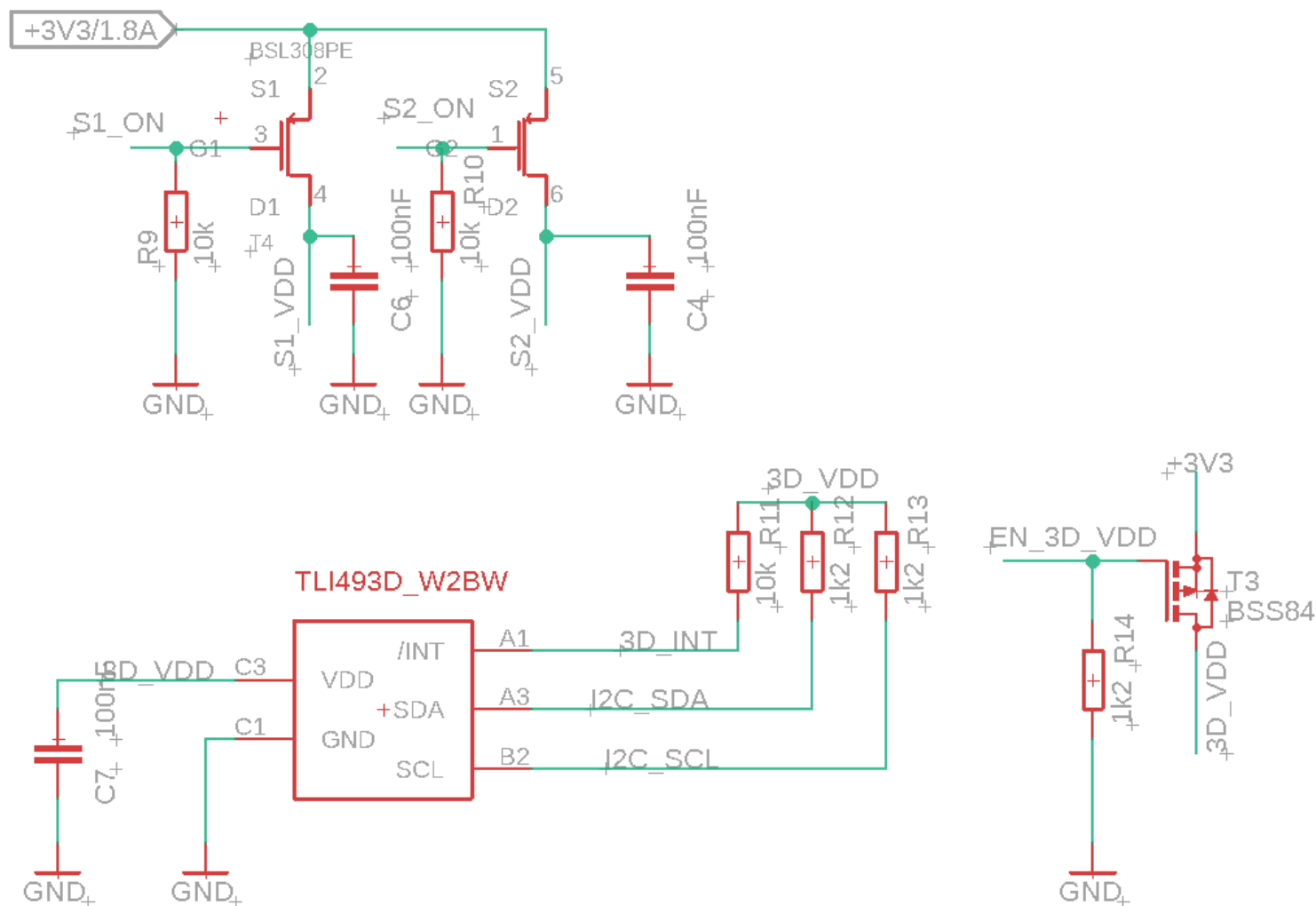

# Detailed schematic: LEDs and connectors

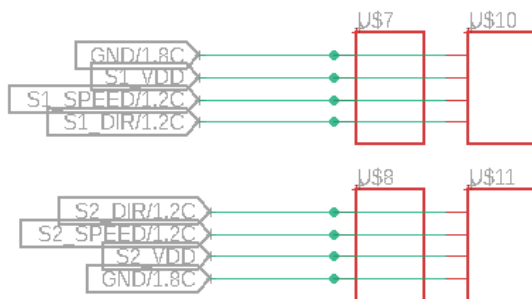
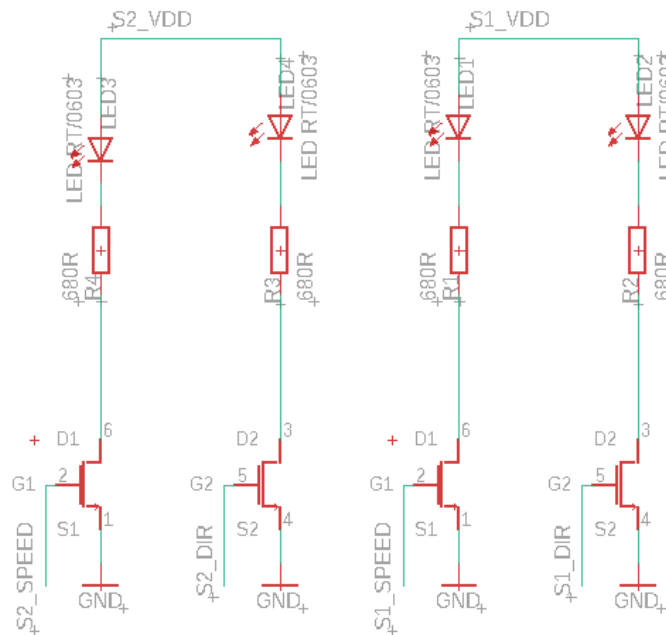

# Detailed schematic: Hall-sensors

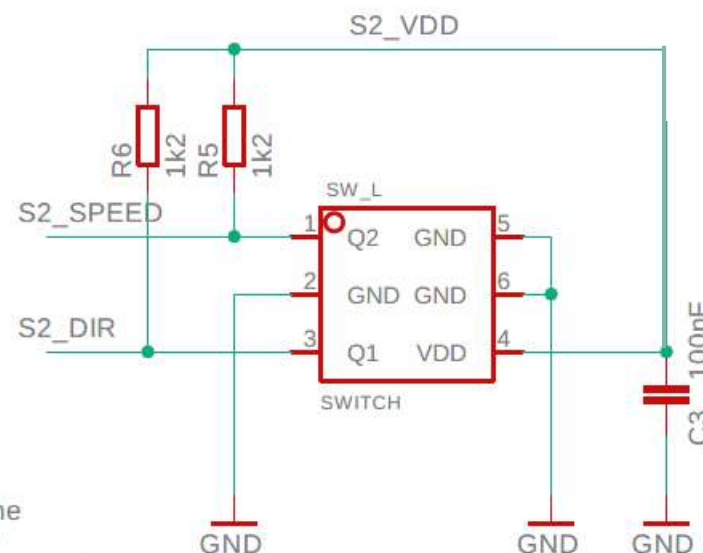
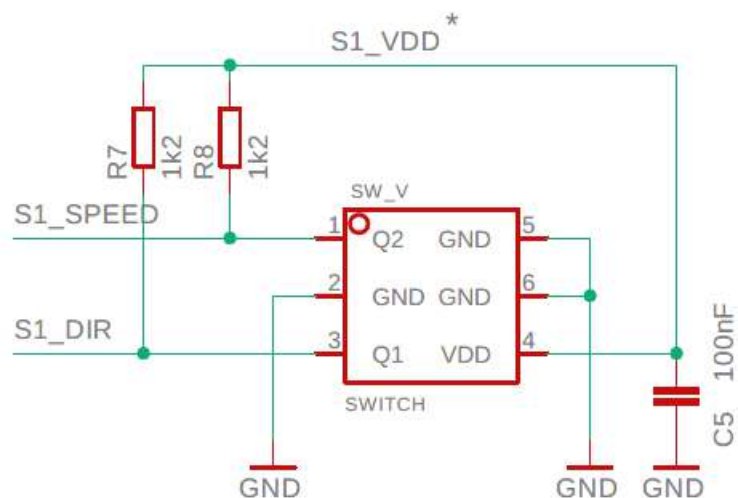

\*Note: to guarantee full TLE4966V-1G performance, in compliance with the datasheet parameters, it is recommended to supply the sensor with VDD higher than 3.5V. For demonstrating the basic functionality we use the power domain of this kit: 3.3V

# Hardware design – layout

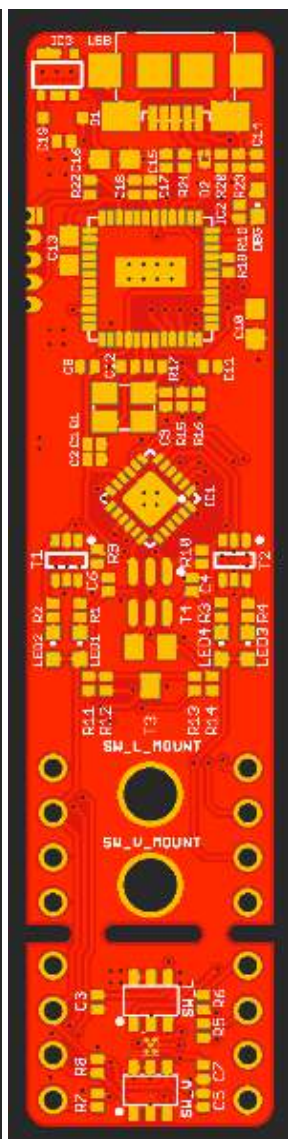
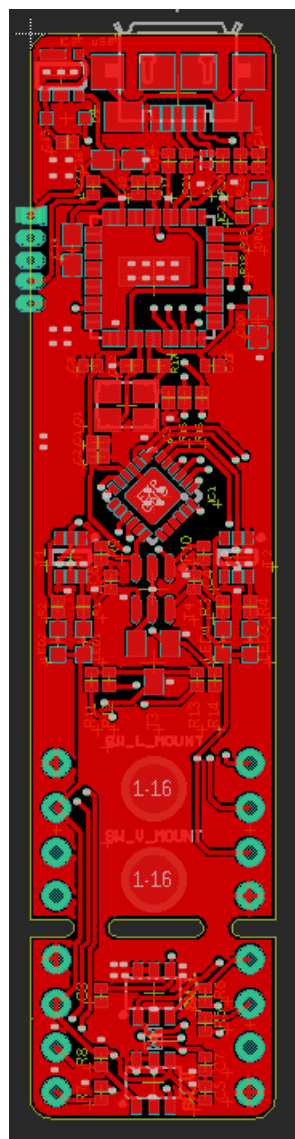

Top layout & render

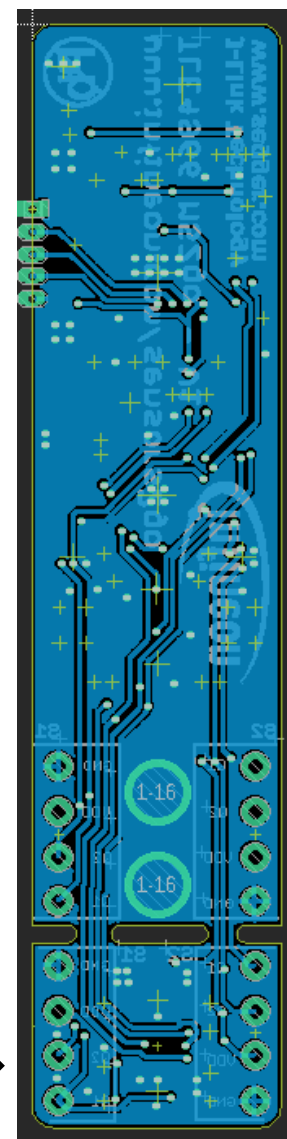

Bottom layout & render





# Agenda

1

Description

2

Content

3

Use-Cases

4

Hardware description & design

5

**Software Installation Process**

6

Software features

# Evaluation Kit Software – Installation (1/6)

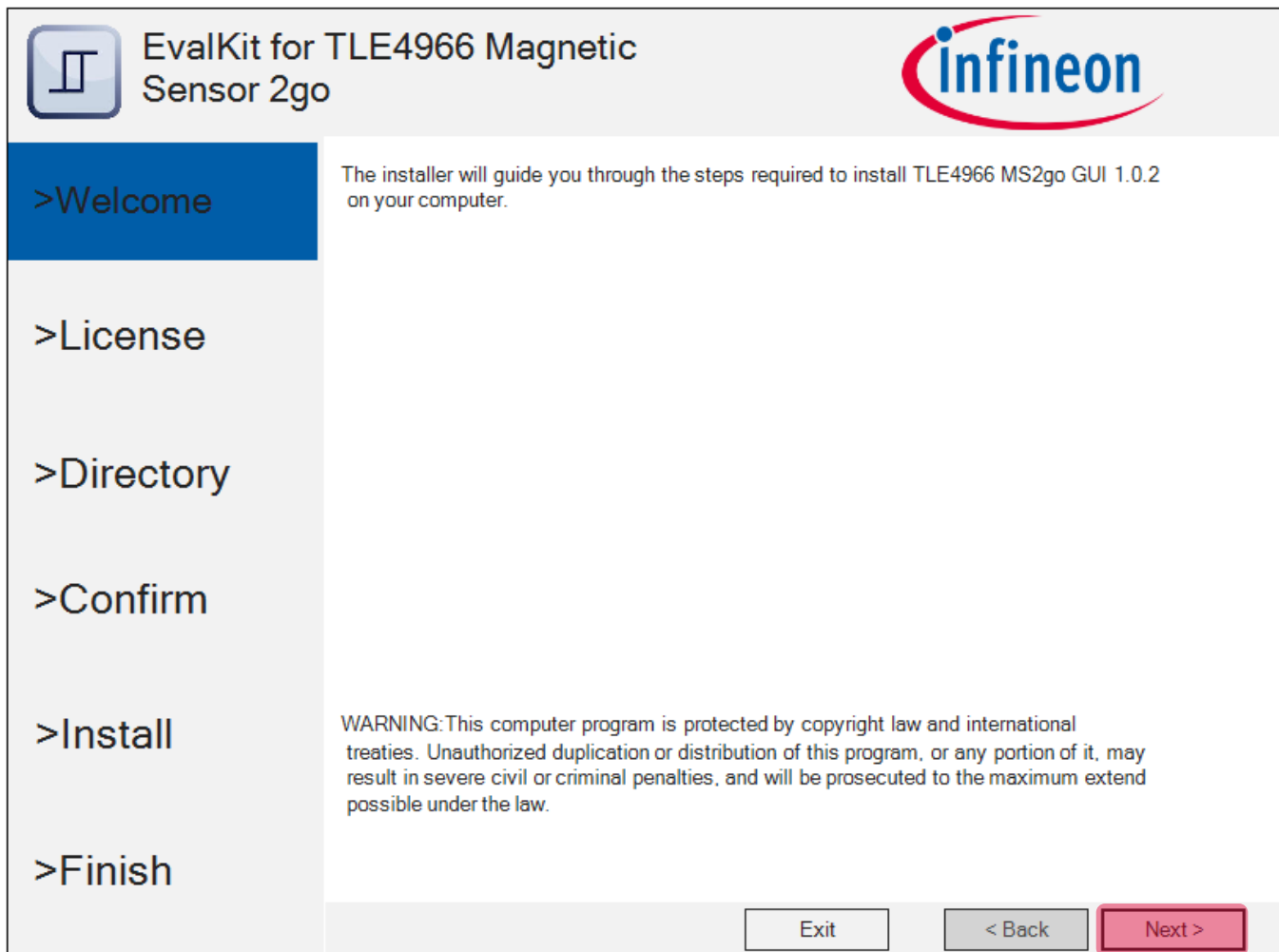

After downloading the Installer from Infineon Website, unzip and run the setup \*.msi file. Make sure you have administrator rights before proceeding.

The installer is starting up by showing the "Welcome" section. Please note that the software version can change over time with no notification.

In order to proceed, please click "Next".

# Evaluation Kit Software – Installation (2/6)



EvalKit for TLE4966 Magnetic  
Sensor 2go



>Welcome

>License

>Directory

>Confirm

>Install

>Finish

### Important Note and Terms of Use

Please read the following important note as well as the following terms and conditions carefully. The extraction of the downloaded documents as well as the installation of the downloaded software is only possible if you agree to such terms and conditions. By clicking the acceptance button “I agree” below, you agree to have read the important note set forth below and to be bound by the following terms of use. If you do not agree to the terms and conditions below, click the button “I do not agree” and the installation procedure will not be started.

**1. Important Note:**

a. THE INFORMATION GIVEN IN THE DOWNLOADED DOCUMENTS IS GIVEN AS A HINT FOR THE IMPLEMENTATION OF THE INFINEON TECHNOLOGIES COMPONENT ONLY AND SHALL NOT BE REGARDED AS ANY DESCRIPTION OR WARRANTY OF A CERTAIN FUNCTIONALITY, CONDITION OR QUALITY OF THE INFINEON TECHNOLOGIES COMPONENT.

I accept the terms in the License Agreement

Exit

< Back

Next >

“Licensing view”: in this view the user is prompted to read the license agreement and accept it. The “Next” button is only activated after accepting the license agreement by checking the highlighted box.

# Evaluation Kit Software – Installation (3/6)

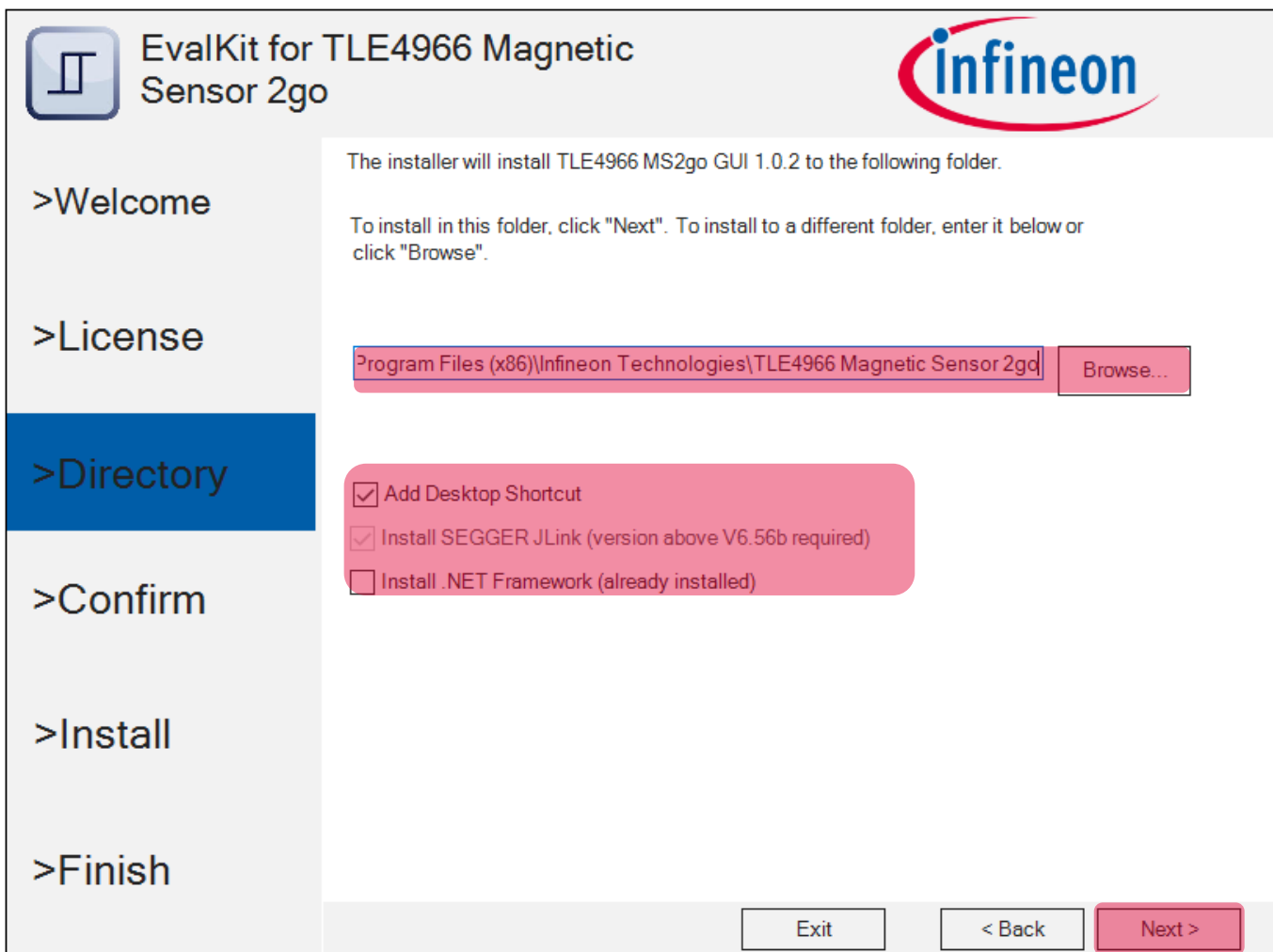

The installer will install TLE4966 MS2go GUI 1.0.2 to the following folder.

To install in this folder, click "Next". To install to a different folder, enter it below or click "Browse".

Program Files (x86)\Infineon Technologies\TLE4966 Magnetic Sensor 2go

Add Desktop Shortcut

Install SEGGER JLink (version above V6.56b required)

Install .NET Framework (already installed)

Exit    < Back    Next >

“Directory view”: in this view the user may select a non-default installation path.

The user may also select the following options: adding a desktop shortcut or installing .NET Framework if not already installed (.NET version 4.5 or later)

The Segger JLINK driver has to be at least newer than version V6.56b – therefore the installation of Segger driver is mandatory. If you are certain that your Jlink Segger driver is newer than V6.56B, than you can close the installer pop-up launched by Segger Driver Installer.

# Evaluation Kit Software – Installation (4/6)



EvalKit for TLE4966 Magnetic Sensor 2go



>Welcome

Click "Install" to begin the installation. Click "Back" to review or change any of your installation settings. Click "Cancel" to exit the wizard.

>License

>Directory

>Confirm

>Install

>Finish

Exit

< Back

Install

"Confirm view": in this view the user shall confirm the installation.

# Evaluation Kit Software – Installation (5/6)

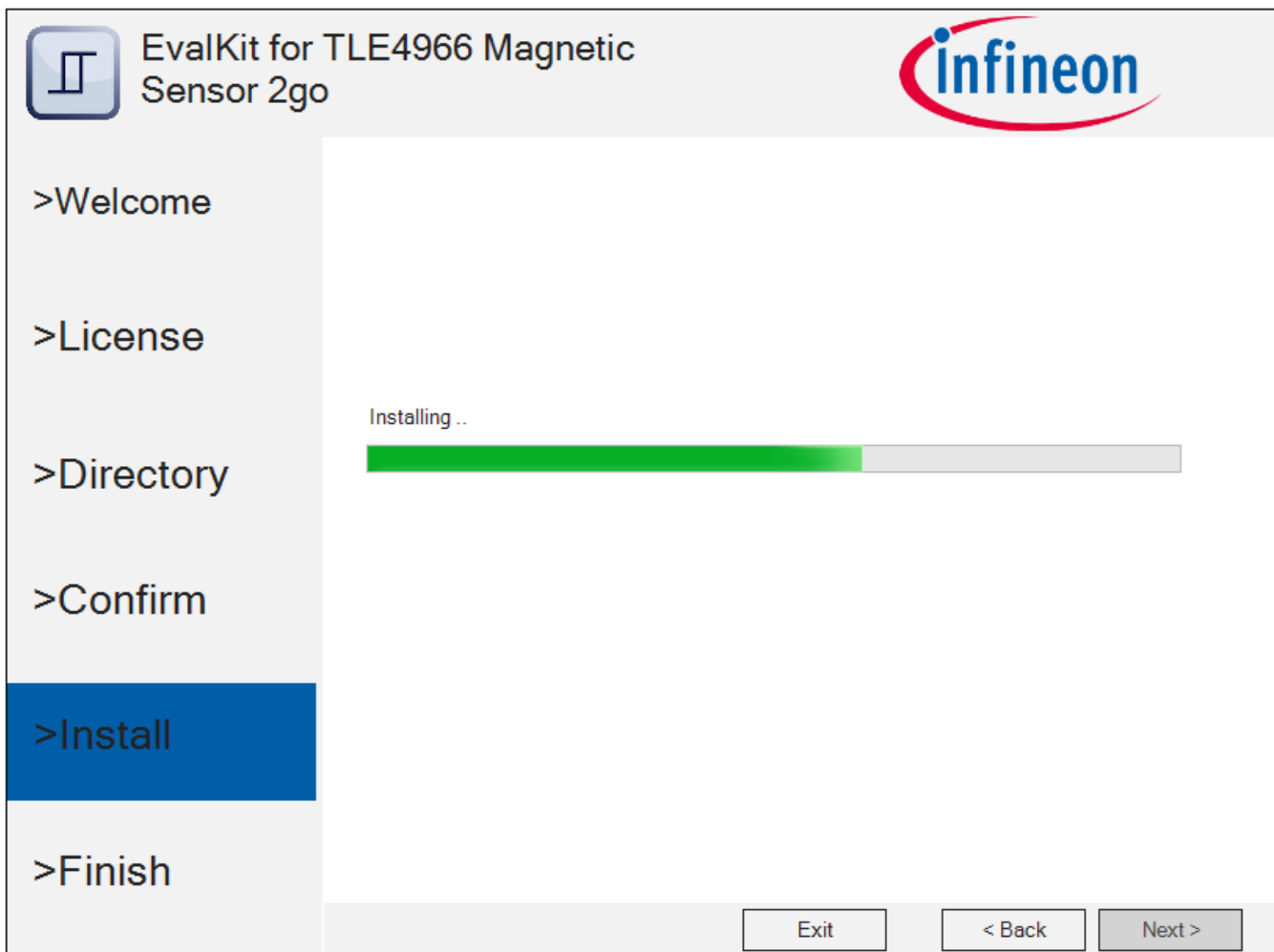

“Install view”: the installation is starting after windows User Access Control (UAC) is providing installation permissions – therefore administration rights have to be provided.

Please wait until the installation is finalized.

Additional installation will be requested by Segger Jlink driver installer.

# Evaluation Kit Software – Installation (6/6)

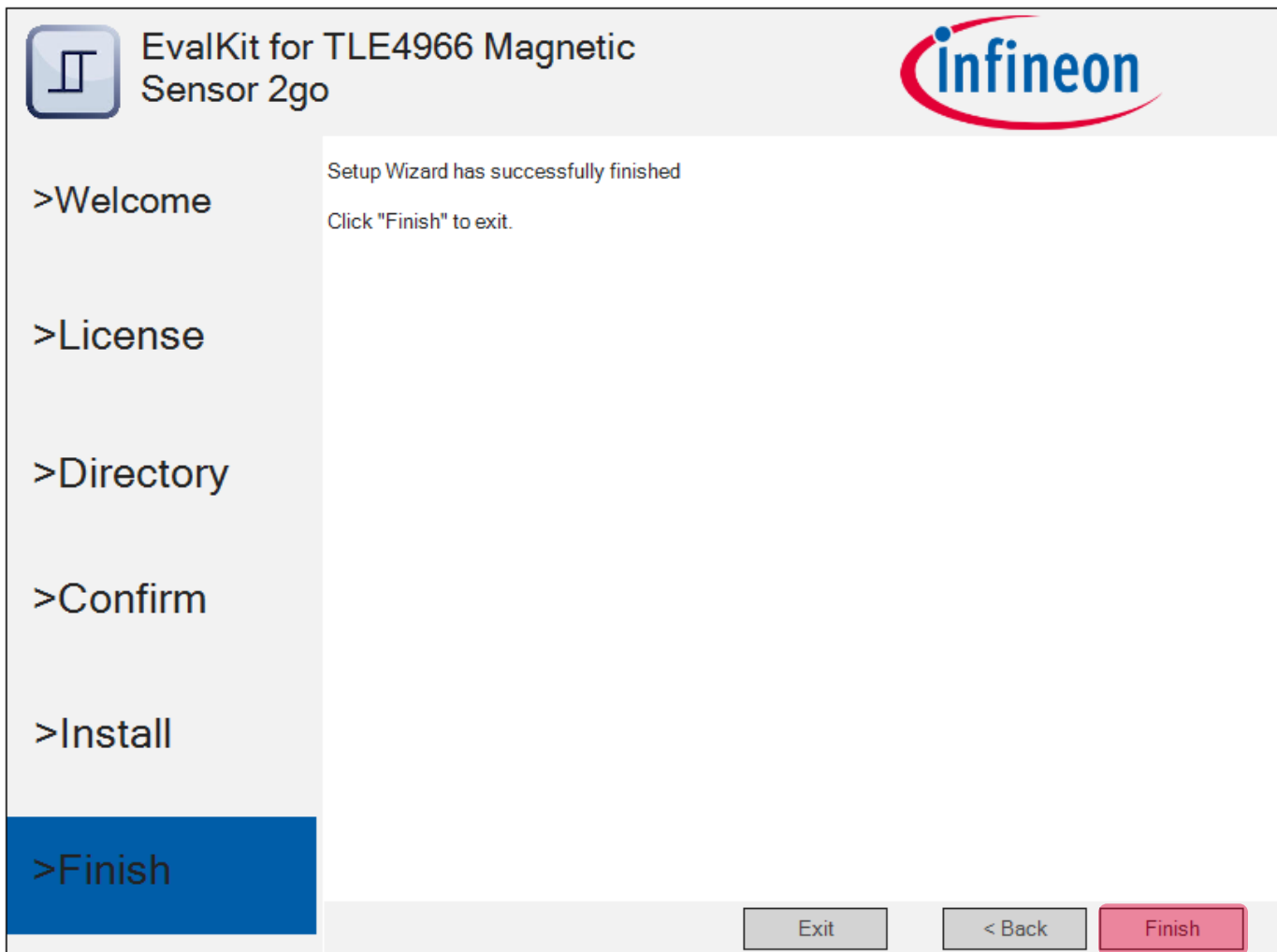

"Finish view": the installation successfully finished. Press "Finish" button for closing the installer.

# Agenda

1

Description

2

Content

3

Use-Cases

4

Hardware description & design

5

Software Installation Process

6

Software features



# Evaluation Kit Software - GUI

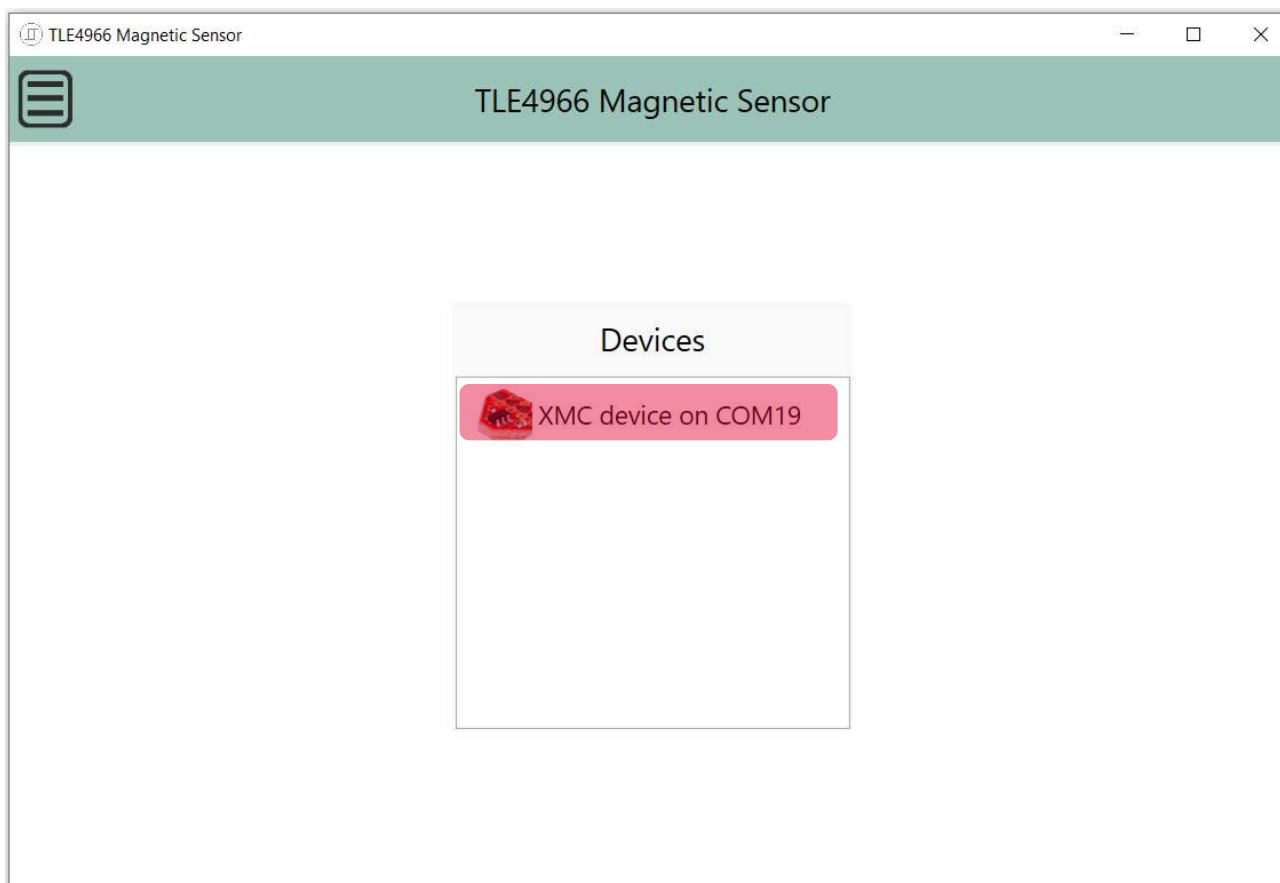

You may start the Graphical User Interface of TLE4966 MS2GO by accessing Windows Start menu -> Infineon Technologies -> TLE4966 MS2GO

Make sure the device is plugged in via micro-USB cable.

One XMC device should be discovered in your Device list. Press on the device in order to flash the correct firmware and to start the application.

# Evaluation Kit Software GUI – Lateral Use Case

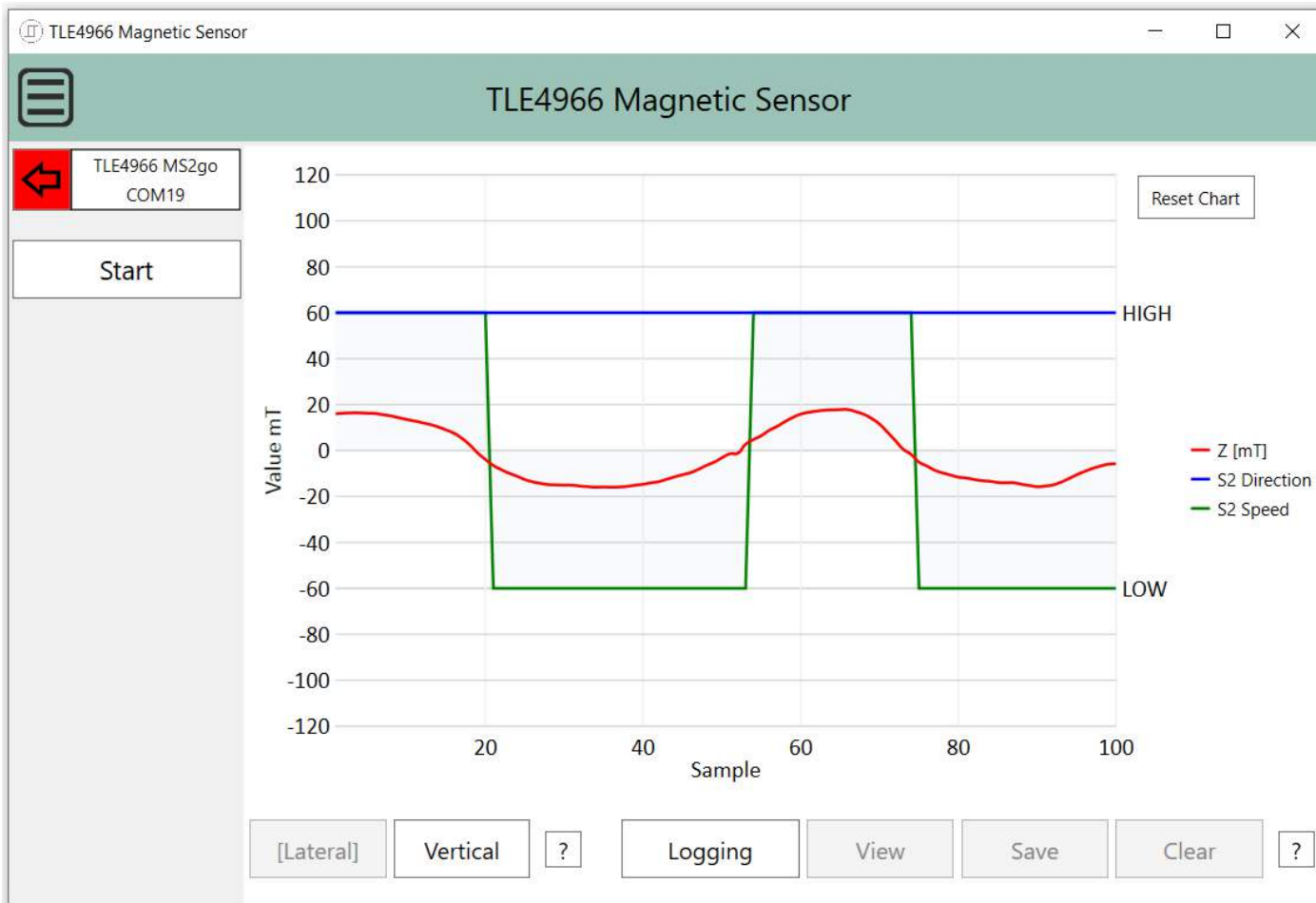

By default, the "Lateral" use-case is enabled. In this case, only the TLE4966G is powered up.

The GUI will acquire and display the outputs Q1(=Direction) and Q2(=Speed) of the lateral sensor synchronized with the 3D magnetic sensor readouts using the Z axis of the magnetic field.

The readout is started by pressing "Start" button.

# Evaluation Kit Software GUI – Vertical Use Case

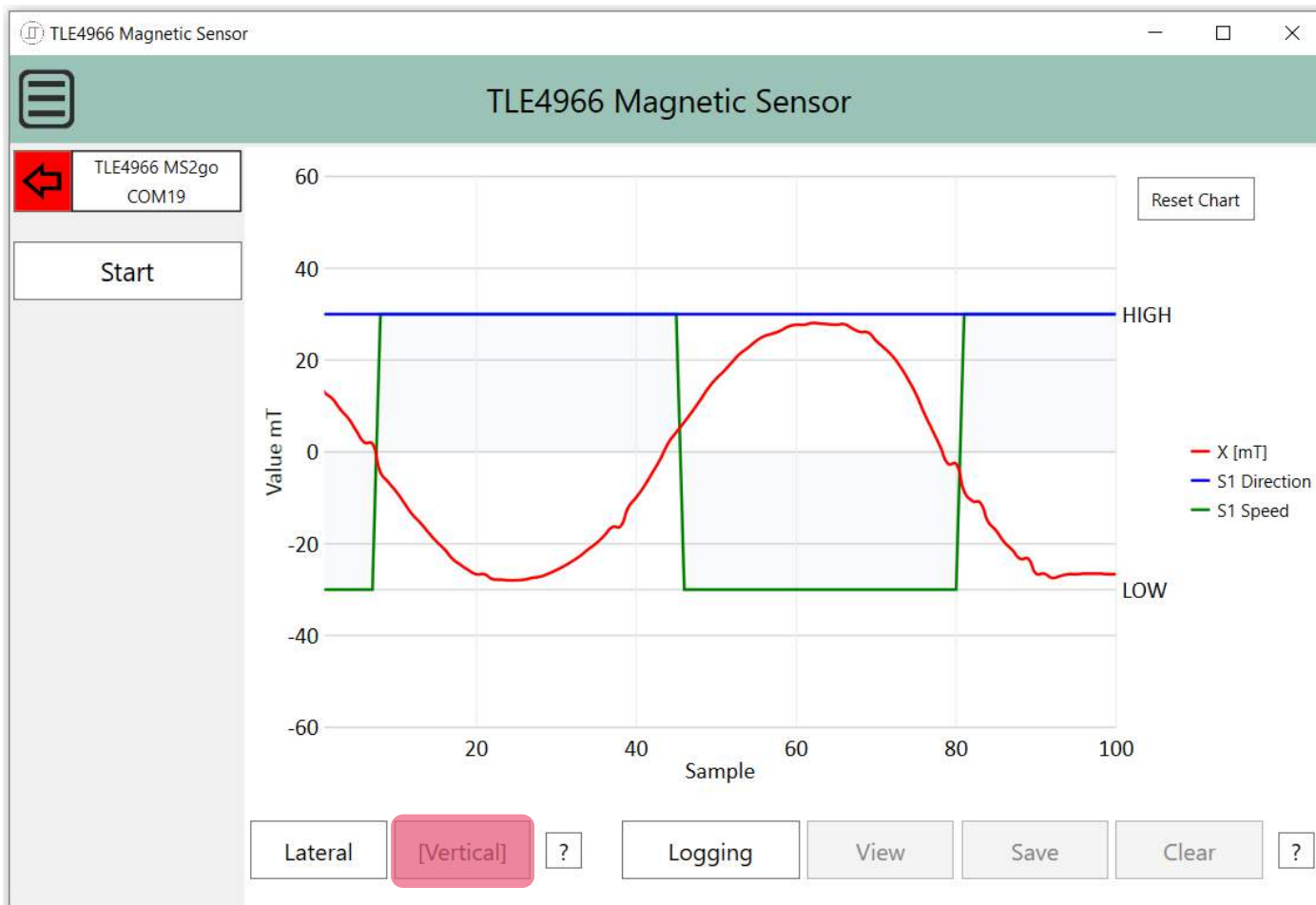

The user may change the use-case to "Vertical" by pressing the "Vertical" button.

In this use-case, the TLE4966V-1G is powered up, while the TLE4966G is not.

The GUI will acquire and display the outputs Q1(=Direction) and Q2(=Speed) of the vertical sensor synchronized with the 3D magnetic sensor readouts using the X axis of the magnetic field.

The readout is started by pressing "Start" button.

# Evaluation Kit Software GUI – Data Logging



If the "Logging" button is pressed before starting the readout the raw data is available for visualization by clicking the "View" button.

A new window will pop out displaying the raw data acquired.

The user may zoom on the wave. All acquired points are visible and a legend will pop-up on when the mouse cursor is over the graph.



The user may save the acquired set of data in CSV format for post-processing.



# Evaluation Kit Software GUI – Explanatory

**Lateral/Vertical Modes Hint** ✕

The Kit supports 2 operation modes  
Click on an image to enlarge

**Lateral mode:**  
Place the bolt in the slot further from the sensor  

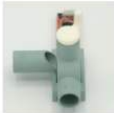
 Insert the Crank in the Y-Z slot  

 Select Lateral Mode [Lateral] Vertical

**Vertical mode:**  
Place the bolt in the slot closest to the sensor  

 Insert the Crank in the X-Y slot  

 Select Vertical Mode L

Close

Further explanation & hints can be discovered by pressing the "?" buttons

**Help: Chart View** — □ ✕

**Logging**  
Pressing this button will toggle data logging. When data logging is enabled, every data point received from the sensor will be stored in memory and can later be visualized or saved to disk.

**View**  
Visualize the data. Use the mouse wheel to zoom and drag with the mouse to pan.

**Save**  
Save logged data to disk.

**Clear**  
Clear the log data from memory.

Close

Lateral

[Vertical]

?

[Logging]

View

Save

Clear

?



Part of your life. Part of tomorrow.

