

PT-40-TE LED™

Thermally Enhanced LED Projection Chipset



Table of Contents

Technology Overview	2
Understanding Luminus Test Specifications	2
Ordering Information	3
Flux /Power Bin Definition	4
Optical & Electrical Characteristics	5- 6
Blue Flux Bin Ranges by Wavelength	7
Characterization Curves	8
Spectrum and Angular Intensity Distribution	9
Thermal Resistance and Electrical Pin Out	10
Mechanical Dimensions	11
Shipping Tray Outline	12
Packing and Shipping Specifications	13
History of Changes	14

Features:

- Matched RGB Chipset with 2.4 mm x 1.6 mm (3.9 mm²) emitting area designed for LED projector applications
- Ultra low thermal resistance, copper-core PCB package
- Wide color gamut: Red-Amber 613 nm, Green 525 nm, Blue 460 nm typical dominant wavelength
- Single emitting area per color allows for collection with single lens for simplified optics
- LED mounted on MC-PCB for easier thermal and optical integration
- LED emitting area optimized and compatible with micro-display diagonal sizes ranging from 0.45" to 0.55"
- Environmentally friendly: RoHS and REACH compliant

Applications

- Specifically engineered for high brightness pocket-size, ultra portable front projectors, head-up projection displays and hybrid projectors
- Optimized for Micro-Display diagonal sizes ranging from 0.45" to 0.55"
- Suitable for DLP™ (0.45" WXGA), LCoS and HTPS /3LCD microdisplays

Technology Overview

Luminus LEDs™ benefit from a suite of innovations in the fields of chip technology, packaging and thermal management. These breakthroughs allow illumination engineers and system designers to achieve solutions that are high brightness and high efficiency.

Packaging Technology

Thermal management is critical in high power LED applications. With a thermal resistance from junction to case of 1.0°C/W , Luminus PT-40 LEDs can be driven at higher current densities while maintaining a low junction temperature, thereby resulting in brighter solutions and longer lifetimes.

Reliability

For high power operation, Luminus LEDs are one of the most reliable light sources in the world today. Luminus LEDs have passed a rigorous suite of environmental and mechanical stress tests, including mechanical shock, vibration, temperature cycling and humidity, and have been fully qualified for use in extreme high power and high current applications. With very low failure rates and median lifetimes that typically exceed 60,000 hours, Luminus LEDs are ready for even the most demanding applications. (Please refer to Luminus' Reliability application note for more information.)

Environmental Benefits

Luminus LEDs help reduce power consumption and the amount of hazardous waste entering the environment. All Luminus LED products manufactured by Luminus are RoHS and REACH compliant and free of hazardous materials, including lead and mercury.

Understanding Luminus LED Test Specifications

Every Luminus LED is extensively tested at rated current to ensure that it meets the high quality standards expected from Luminus products.

Testing of Luminus LEDs

Luminus core board products are typically measured in such a way that the characteristics reported agree with how the devices will actually perform when incorporated into a system. This measurement is accomplished by mounting the devices on a 40°C heat sink and allowing the device to reach thermal equilibrium while fully powered. Only after the device reaches equilibrium are the measurements taken. This method of measurement ensures that Luminus LEDs perform in the field just as they are specified.

Ordering Information

Ordering Part Number ¹	Color	Min Flux or Power Bin ²	Description
PT-40-RAX-L55-MPH	Red-Amber	2H	Red-Amber LED, consisting of a 3.9 mm ² Red-Amber LED chip and connector mounted on a copper-core PCB (note: reverse polarity pin-out).
PT-40-RAX-L55-MPJ		2J	
PT-40-G-L51-MPH	Green	2H	Green LED, consisting of a 3.9 mm ² Green LED chip and connector mounted on a copper-core PCB.
PT-40-G-L51-MPJ		2J	
PT-40-B-L51-EPH	Blue	2H	Blue LED, consisting of a 3.9 mm ² Blue LED chip and connector mounted on a copper-core PCB.
PT-40-B-L51-EPJ		2J	

Note 1: Ordering part numbers represent bin kits (group of bins that are shippable for a given ordering part number)

Note 2: See Bin Kit and Flux / Power bin definitions on page 4

Ordering Part Number Nomenclature

XXX — 00 — XXXX — X00 — XXX

Product Family	Chip Area	Color	Package Configuration	Bin Kit ¹
PT: Metal Coreboard PCB	40: 3.9 mm ²	RAX= Red -Amber (613nm, typ) G= Green B= Blue	L51: 21.85 mm x 15.0 mm (See Mechanical Drawing section)	See page 4 for bin kit definition

Note 1: A Bin Kit represents a group of individual flux or power bins that are shippable for a given ordering part number. Individual flux bins are not orderable.

EXAMPLE:

PT-40-G-L51-MPH is comprised of Green Flux Bins 2H, 2J, 2K, 2L, 2M

PT-40 Bin Kit¹ and Flux Bin^{2,3,4} Definitions

Note: Please refer to ordering part number table on page 3 for Bin Kit availability

Red -Amber Flux Bins	Bin 2H	Bin 2J	Bin 2K	Bin 2L	Bin 2M			
Red -Amber Bin Flux Range (lm)	800-860	860-925	925-990	990-1055	1055-1125			
PT-40-RAX-L55-MPH	<input checked="" type="checkbox"/>	<input checked="" type="checkbox"/>	<input checked="" type="checkbox"/>	<input checked="" type="checkbox"/>				
PT-40-RAX-L55-MPJ		<input checked="" type="checkbox"/>	<input checked="" type="checkbox"/>	<input checked="" type="checkbox"/>	<input checked="" type="checkbox"/>			
Green Flux Bins	Bin 2H	Bin 2J	Bin 2K	Bin 2L	Bin 2M	Bin 2N		
Green Bin Flux Range (lm)	1450-1550	1550-1660	1660-1780	1780-1900	1900-2020	2020-2150		
PT-40-G-L51-MPH	<input checked="" type="checkbox"/>	<input checked="" type="checkbox"/>	<input checked="" type="checkbox"/>	<input checked="" type="checkbox"/>	<input checked="" type="checkbox"/>			
PT-40-G-L51-MPJ		<input checked="" type="checkbox"/>	<input checked="" type="checkbox"/>	<input checked="" type="checkbox"/>	<input checked="" type="checkbox"/>	<input checked="" type="checkbox"/>		
Blue Flux Bins	Bin 2H	Bin 2J	Bin 2K	Bin 2L	Bin 2M	Bin 2N		
Blue Bin Flux Range (lm)	280-300	300-320	320-345	345-370	370-400	400-430		
PT-40-B-L51-EPH	<input checked="" type="checkbox"/>	<input checked="" type="checkbox"/>	<input checked="" type="checkbox"/>	<input checked="" type="checkbox"/>	<input checked="" type="checkbox"/>			
PT-40-B-L51-EPJ		<input checked="" type="checkbox"/>	<input checked="" type="checkbox"/>	<input checked="" type="checkbox"/>	<input checked="" type="checkbox"/>	<input checked="" type="checkbox"/>		

- Note 1: Bin Kits are defined by a group of flux or power bins. Only one flux bin will be shipped in each individual pack. A shipment will contain packs of different allowed flux bins for a particular ordering part number. Individual Flux or Power bins are not orderable.
- Note 2: PT-40 LEDs are tested for luminous flux at 9.8 A at 25% duty cycle for Red-Amber and Blue, and at 50% duty cycle for Green Devices. Devices are sorted and packed by flux bin. Not all flux bins are currently populated.
- Note 3: Luminus maintains a test measurement accuracy for LED flux and power of +/- 6%.
- Note 4: Blue Flux bin limits are defined at reference dominant wavelength of 462 nm. See table on page 7 for Blue bin limits at other dominant wavelengths.

Optical & Electrical Characteristics

General Characteristics		Symbol	Red -Amber Preliminary	Green Preliminary	Blue Preliminary	Unit
Emitting Area			3.9	3.9	3.9	mm ²
Emitting Area Dimensions			2.42 x 1.61	2.42 x 1.61	2.42 x 1.61	mmxmm
Characteristics at Recommended Test Drive Current , I_f^{1,2}						
Reference Duty Cycle ³			25	50	25	%
Test Peak Drive Current ^{1,2,4}	typ	I _F	9.8	9.8	9.8	A
Peak Luminous Flux ^{1,2,5}	typ	Φ _v	860	1750	300	lm
Peak Radiometric Flux ^{1,2}	typ	Φ _r	3.0	3.5	6.2	W
Dominant Wavelength	min	λ _{dmin}	609	516	450	nm
	typ	λ _d	613	525	460	nm
	max	λ _{dmax}	620	540	468	nm
FWHM- Spectral bandwidth at 50% of Φ _r	typ		19	34	20	nm
Chromaticity Coordinates ^{6,7}	typ	x	0.675	0.167	0.147	
	typ	y	0.325	0.704	0.033	
Forward Voltage	min	V _{Fmin}	2.7	3.5	3.2	V
	typ	V _F	3.1	5.1	3.8	V
	max	V _{Fmax}	3.7	5.9	5.2	V
Dynamic Resistance	typ		0.13	0.12	0.09	Ω
Device Thermal Characteristics						
Thermal Coefficient of Photometric Flux	typ		-1	-0.2	~0	% / °C
Thermal Coefficient of Radiometric Flux	typ		-0.7	-0.2	-0.2	% / °C
Forward Voltage Temperature Coefficient	typ		-2	-4.7	-3	mV/ °C

Note 1: All ratings are based on testing conditions with a constant heat sink temperature T_{hs} = 40° C. See Thermal Resistance section for T_{hs} definition.

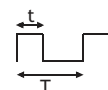
Note 2: Parameters rated at test duty cycle and Pulsed operation frequency f > 240 Hz; DC = $\frac{t}{T}$ 

Note 3: Duty Cycle used to specify device ratings under Pulsed operation. Big Chip LED devices can operate at duty cycles ranging from 1% to 100%. At higher duty cycles, drive current should be adjusted to maintain the junction temperature at desired levels to meet the application lifetime requirements.

Note 4: In pulsed operation, rise time from 10% to 90% of forward current should be larger than 0.5 microseconds.

Note 5: For Blue devices, total flux from emitting area at typical dominant wavelength. Refer to page 7 for brightness specifications at other wavelengths.

Note 6: CIE 1931 chromaticity diagram coordinates, normalized to X+Y+Z=1.

Note 7: For reference only.

Optical & Electrical Characteristics

Absolute Maximum Ratings (Preliminary)

	Symbol	Red -Amber	Green	Blue	Unit
Absolute Minimum Current (CW or Pulsed) ¹		200	200	200	mA
Absolute Maximum Current (CW) ²		8.6	8.6	8.6	A
Absolute Maximum Current (Pulsed) ^{2,3} (frequency > 240Hz, duty cycle <50%)		11.7	11.7	11.7	A
Absolute Maximum Surge Current ^{2,3} (Frequency > 240 Hz, duty cycle =10%, t=1ms)		13.7	13.7	13.7	A
Maximum Operating Junction Temperature ⁴	T _{jmax,op}	100	140	130	°C
Absolute Maximum Junction Temperature ⁴	T _{jmax}	125	170	170	°C
Storage Temperature Range		-40 / +100	-40 / +100	-40 / +100	°C

Note 1: Product performance and lifetime data is specified at recommended forward drive currents. Sustained operation at or near absolute minimum currents may result in a reduction of device performance and device lifetime compared to recommended forward currents.

Note 2: Maximum forward drive current conditions for continuous operation are 8.6 A, CW (2.2 A/mm²), and 11.7 A, f>240 Hz, duty cycle <70% (3.0 A/mm²). Sustained operation above maximum currents is not recommended and will result in a reduction of device lifetime compared to specified maximum forward drive currents. Device lifetimes will depend on junction temperature (see Reliability Application Note, APN-001444 for product lifetimes as function of junction temperature). Please refer to lifetime de-rating curves (available from Luminus) for further information.

Note 3: In pulsed operation, rise time from 10 to 90% of forward current should be larger than 0.5 microseconds.

Note 4: Sustained operation at or above Maximum Operating Junction Temperature (T_{jmax}) will result in significant reduction in device lifetime.

Blue Bin Flux Ranges by Dominant Wavelength ^{1,2}

DWL (nm)	Bin2H		Bin 2J		Bin 2K		Bin 2L		Bin 2M		Bin 2N	
	Min (lm)	Max (lm)	Min (lm)	Max (lm)	Min (lm)	Max (lm)	Min (lm)	Max (lm)	Min (lm)	Max (lm)	Min (lm)	Max (lm)
450	137	147	147	156	156	169	169	181	181	196	196	210
451	149	159	159	170	170	183	183	197	197	213	213	229
452	161	172	172	184	184	198	198	212	212	230	230	247
453	173	185	185	197	197	213	213	228	228	247	247	265
454	185	198	198	211	211	227	227	244	244	264	264	283
455	197	211	211	225	225	242	242	260	260	281	281	302
456	208	223	223	238	238	257	257	275	275	298	298	320
457	220	236	236	252	252	272	272	291	291	315	315	338
458	232	249	249	265	265	286	286	307	307	332	332	357
459	244	262	262	279	279	301	301	323	323	349	349	375
460	256	274	274	293	293	316	316	338	338	366	366	393
461	268	287	287	306	306	330	330	354	354	383	383	412
462	280	300	300	320	320	345	345	370	370	400	400	430
463	292	313	313	334	334	360	360	386	386	417	417	448
464	304	326	326	347	347	374	374	402	402	434	434	467
465	316	338	338	361	361	389	389	417	417	451	451	485
466	328	351	351	375	375	404	404	433	433	468	468	503
467	340	364	364	388	388	418	418	449	449	485	485	522
468	352	377	377	402	402	433	433	465	465	502	502	540

Note 1: Flux Min, Max values are continuous as function of dominant wavelength values. For illustration purposes, flux Min and Max values are provided at discrete dominant wavelength values.

Note 2: Luminus maintains a test measurement accuracy for LED flux and power of +/- 6%.

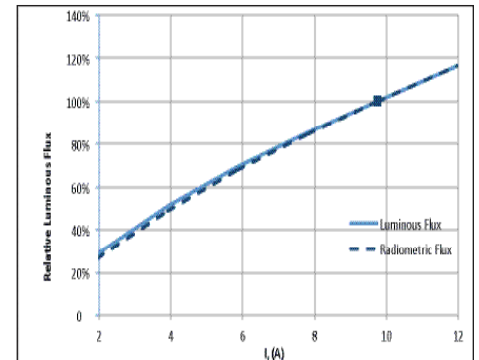
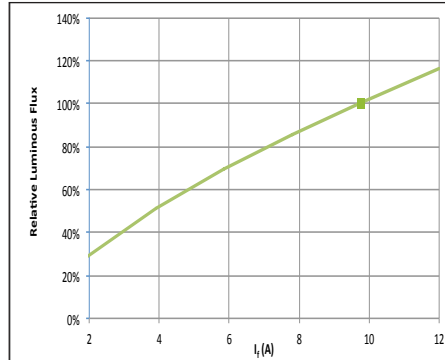
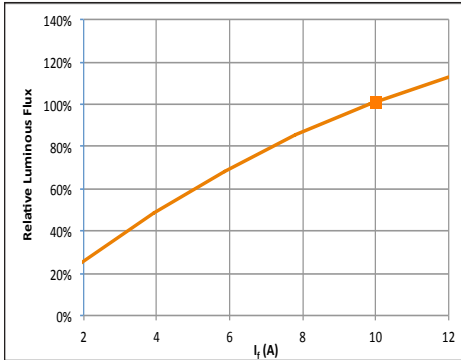
Normalized Luminous Flux variation with Forward Current: $\Phi_V(I_F) / \Phi_V(9.8\text{ A})$

See notes 1, 2 on page 9.

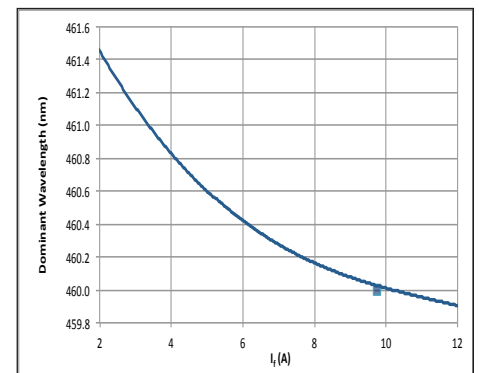
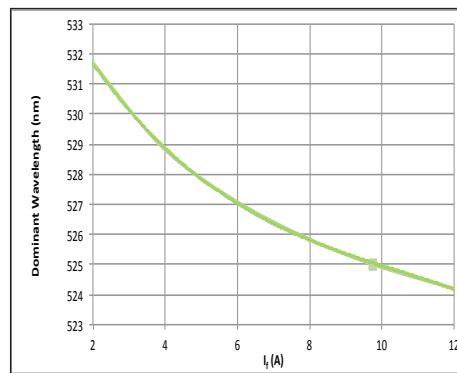
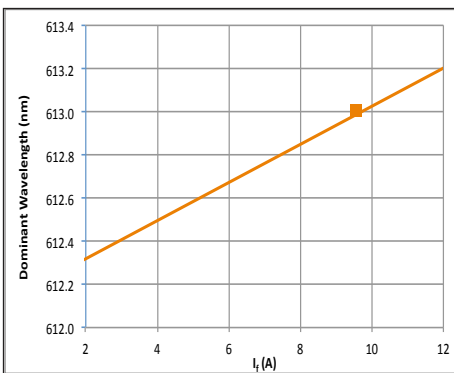
Dominant Wavelength variation with Forward Current - $\lambda_d = f(I_F)$ - Typical

See notes 1, 2 on page 9.

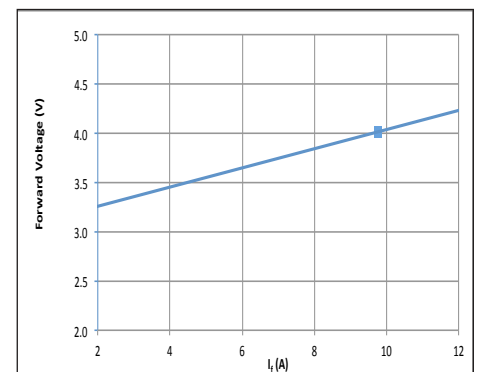
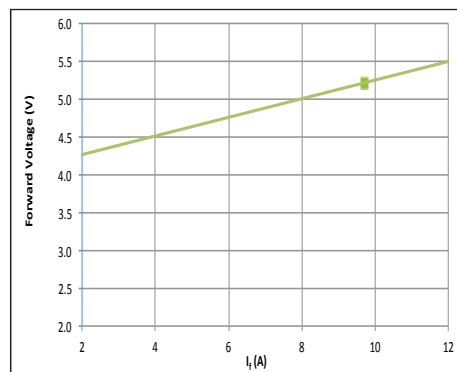
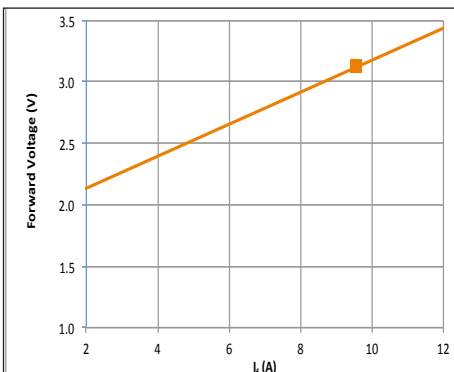
Forward Voltage variation with Drive Current - $V_F = f(I_F)$ - Typical

See notes 1, 2 on page 9.

Optical Spectrum (Typical)

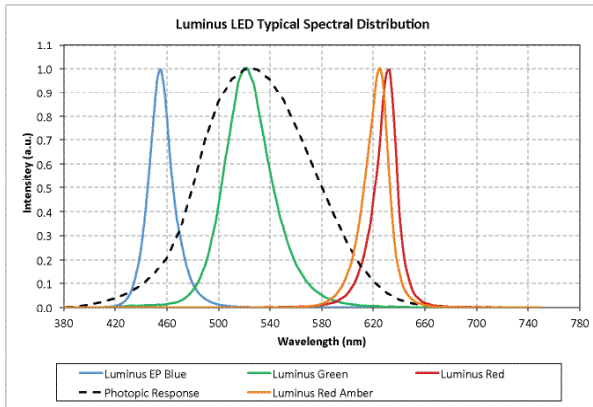

See notes 1, 3 on page 9.

Angular Intensity Distribution (Typical)

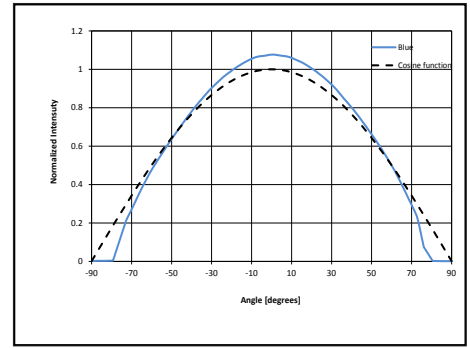
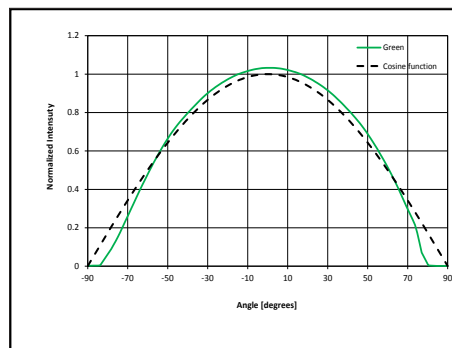
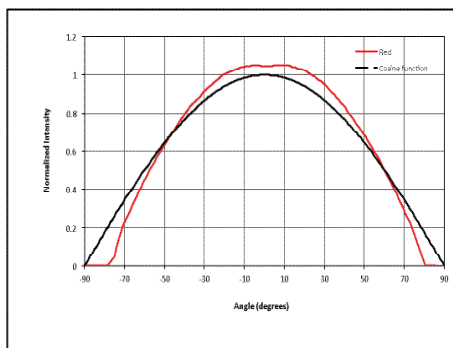

See note 4 on page 9.

- Note 1: For Pulsed operation, the reference R,G, and B duty cycles used are 25%, 50% and 25% respectively ($T_{hs}=40^{\circ}C$; Frequency =720 Hz).
- Note 2: Square on curves indicates device operating current point (9.8A) under reference conditions listed in the Optical and Electrical Characteristics table.
- Note 3: Typical spectrum at recommended peak drive current . Please contact Luminus to obtain data in Excel format.
- Note 4: Curves (solid) represent the angular radiation pattern of a typical (Red, Green or Blue) device. Discontinuous line represents cosine function. For any specific device, slight variations may be expected.

Thermal Resistance

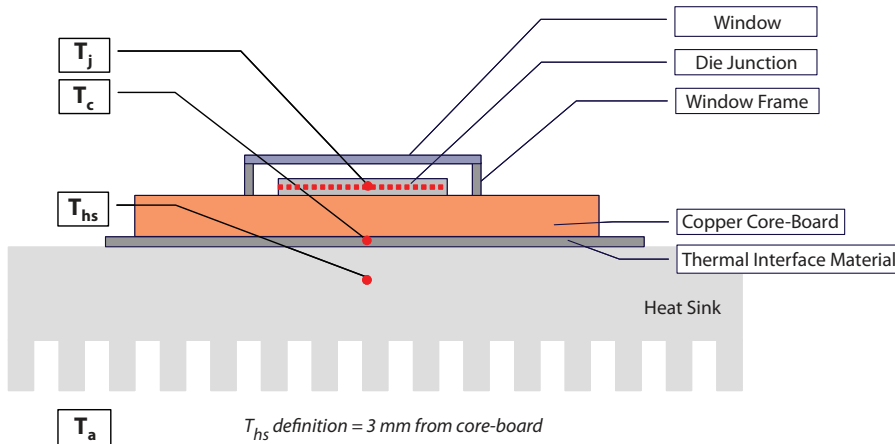

Typical Thermal Resistance

$R_{\theta j-b}^1$	1.0 °C/W
$R_{\theta b-hs}^2$	0.2 °C/W
$R_{\theta j-hs}^{1,2}$	1.2 °C/W

Note 1: Thermal resistance values are preliminary and are based on modeled results correlated to measured $R_{\theta j-hs}$ data using the wavelength shift method. Verification of compliance with the recent releases of JEDEC Standards JESD51-14 and JESD51-5x series is pending.

Note 2: Thermal Resistance is based on eGraf 1205 Thermal interface.

Electrical Pinout

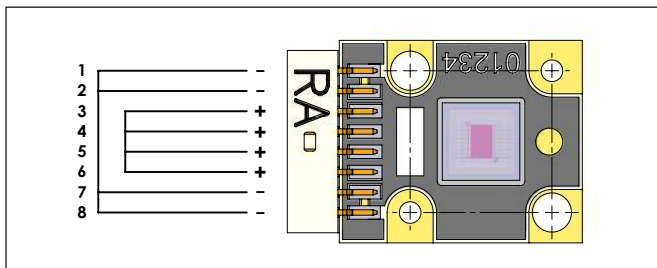

Red Devices

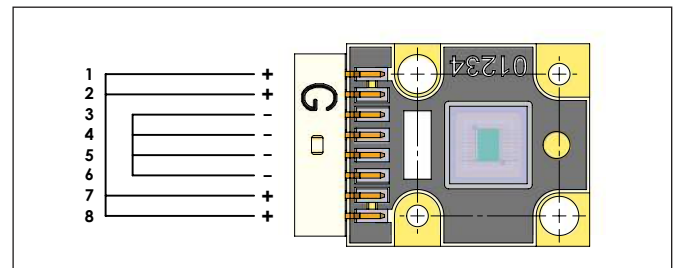

Green and Blue Devices

Mechanical Dimensions

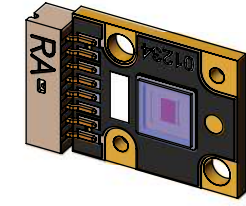
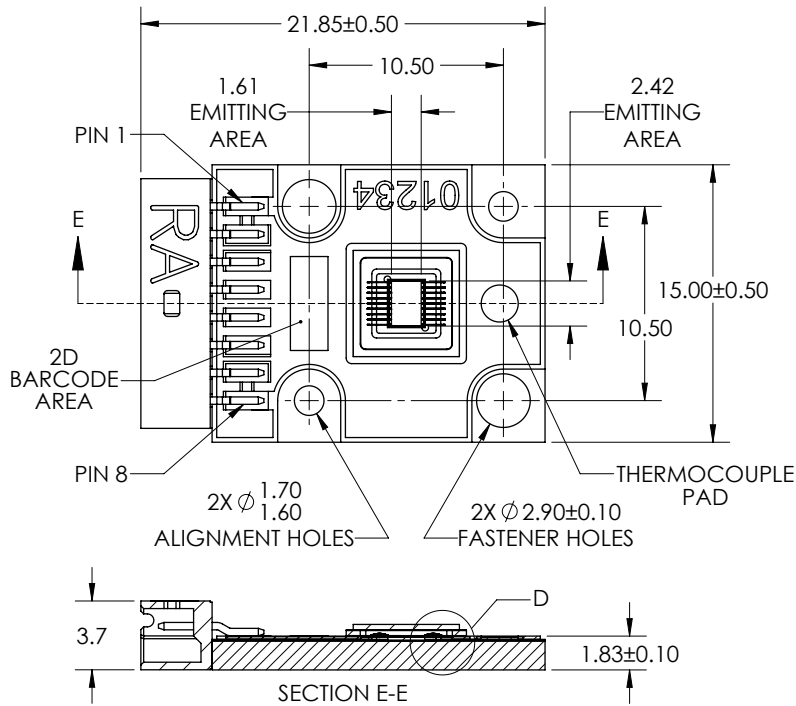

RED AMBER LED DEVICE

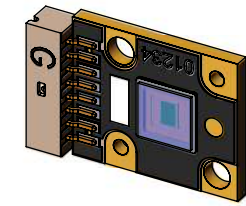

GREEN LED DEVICE

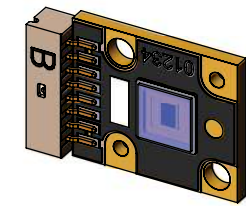

BLUE LED DEVICE

PIN ASSIGNMENTS		
LED COLOR	CATHODE (-)	ANODE (+)
BLUE	3,4,5,6	1,2,7,8
GREEN	1,2,7,8	3,4,5,6
RED AMBER	1,2,7,8	3,4,5,6

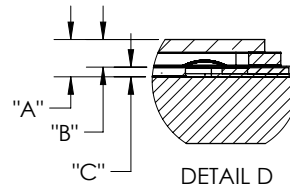

DIMENSION NAME	DESCRIPTION	NOMINAL DIMENSION	TOLERANCE
"A"	TOP OF METAL SUBSTRATE TO TOP OF WINDOW	0.88	±0.13
"B"	TOP OF EMITTING AREA TO TOP OF WINDOW	0.65	±0.11
"C"	TOP OF METAL SUBSTRATE TO TOP OF DIE EMITTING AREA	0.23	±0.02

DWG-002102

Notes:

- Whereas PT40 Green and Blue LEDs are packaged in a common anode copper core board, PT40 Red LEDs are packaged in a common cathode copper core board, with a footprint of 21.85mm x 15 mm.
- Dimensions above are for information only. Please refer to the latest revision of the DWG- 002102 package outline mechanical specifications.
- Connector Information:
 Manufacturer: Tarng-Yu
 Part # TU1512WNR-08SI-GO-M8-NL-A
- Mating female connector information:
 Manufacturer: Tarng-Yu
 Part # TU1512HNO-08-M5; contact terminal part # TU1512TPO-GO
- PT-40 Mating Connector Cable Assembly ordering part number (small quantity orders for evaluation purposes only): 960041

Shipping Tray Outline

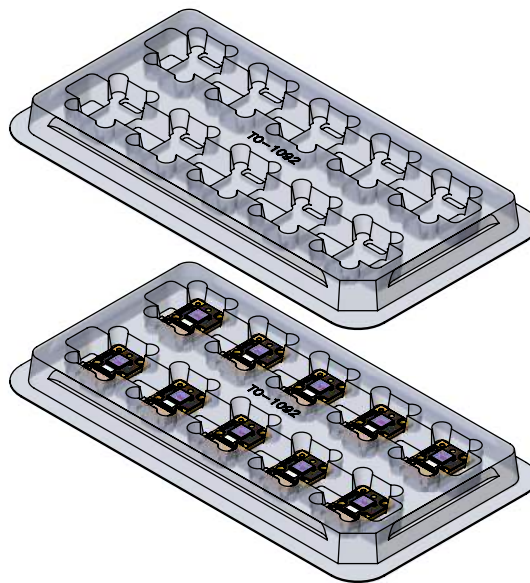
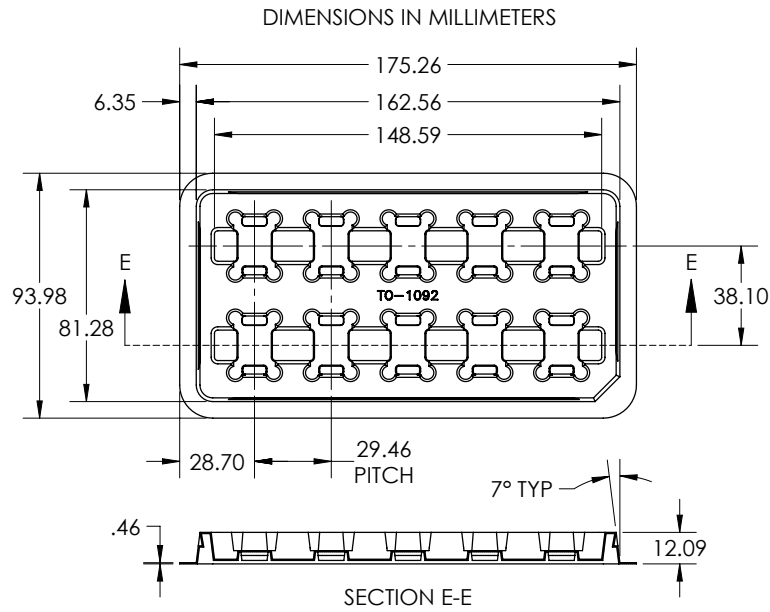

For detailed drawing of shipping tray, please refer to document TO-1092, available upon request.

Packing and Shipping Specifications

Packing Specification







Packing Configuration	Qty /Pack	Pack Dimensions (L x W x H, mm)	Gross Weight (kg)
Stack of 5 trays with 10 devices per tray Each pack is enclosed in ESD bag	50	18 x 10 x 4	0.29

Product Label Specification

Label Fields:

- 6-8 digit Box number (for Luminus internal use)
- Luminus ordering part number
- Quantity of devices in pack
- Part number revision (for Luminus internal use)
- Customer's part number (optional)
- Flux Bin
- 2D Bar code



<p>BP-012345  Box number</p> <p>PT-40-RAX-L55-MPK  Luminus part number</p> <p>12345678  Customer part number</p> <p>2K  Bin</p>	<p>Qty: 50 </p> <p>Rev 01 </p>		for traceability peel off label and attach
---	--	---	--

RoHS Compliant

Sample label –for illustration only

Shipping Box

Shipping Box	Quantity	Material	Dimensions (L x W x H, mm)
Carton Box	1 -20 packs	S4651	560 x 560 x 200

History of Changes

Revision	Date	Description of Change
01	11/29/12	Preliminary Datasheet
02	03/08/13	Update ordering part numbers and characterization curves
03	4/15/14	Update t.b.d items on Rev 02 datasheet

The products, their specifications and other information appearing in this document are subject to change by Luminus Devices without notice. Luminus Devices assumes no liability for errors that may appear in this document, and no liability otherwise arising from the application or use of the product or information contained herein. None of the information provided herein should be considered to be a representation of the fitness or suitability of the product for any particular application or as any other form of warranty. Luminus Devices' product warranties are limited to only such warranties as accompany a purchase contract or purchase order for such products. Nothing herein is to be construed as constituting an additional warranty. No information contained in this publication may be considered as a waiver by Luminus Devices of any intellectual property rights that Luminus Devices may have in such information. Big Chip LEDs™ is a registered trademark of Luminus Devices, Inc., all rights reserved.

This product is protected by U.S. Patents 6,831,302; 7,074,631; 7,083,993; 7,084,434; 7,098,589; 7,105,861; 7,138,666; 7,166,870; 7,166,871; 7,170,100; 7,196,354; 7,211,831; 7,262,550; 7,274,043; 7,301,271; 7,341,880; 7,344,903; 7,345,416; 7,348,603; 7,388,233; 7,391,059 Patents Pending in the U.S. and other countries.