

GlobTek, Inc. www.globtek.com 186 Veterans Drive, Northvale, NJ 07647 Tel. (201) 784-1000 Fax (201) 784-0111	Drawing Title: GTM46161-155.0-USB2C, ICT / ITE / Medical Power Supply, Efficiency Level: USA DOE Level VI / Eco-design Directive 2009/125/EC, (EU) 2019/1782, Case Color/Style: GlobTek White, Wall Plug-in, Regulated Switchmode AC-DC Power Supply AC Adaptor, Input Rating: 100-240V~, 50-60 Hz, Interchangeable Blades http://en.globtek.com/interchangeable-blades.php , Output Rating: 15W, 5.0V@3.0A, Output Configuration: N/A mm, N/A/4 Cond, N/A, Dual Type "C" USB "JACKS", integral to power supply enclosure compliant with Directive (EU) 2022/2380 and 2014/53/EU Radio Equipment Directive (RED), Ferrite: None, N/A, GT Cord # C69399, Pin Out: A1, A12, B1, B12: GND A4, A9, B4, B9: V+ CC1: A5 CC2: B5 D+: A6, B6 D-: A7, B7, Blades/Input Cord: White color, Approvals:	
	Model No. GTM46161-155.0-USB2C	
	Part No./Ordering No. WR9QA3000USBC2CNAIMR6W	Rev B

In Addition to GlobTek Inc.'s renewed ISO9001:2015 - Quality Management System Certification, GlobTek Inc. is now certified to:

ISO13485:2016 - Medical Devices Quality Management System Certification
ISO14001:2015 - Environmental Management System Certification

ISO Certificates are available online at <https://www.globtek.com/iso-certificates/>

The acceptance of this specification and use of the product described in this document indicates the acceptance and binding of the customer to Globtek TERMS AND CONDITIONS (attached to the end of this document), which supersede all other agreements, terms, and conditions (<https://en.globtek.com/terms-and-conditions/>).

The purchaser of this product (Customer) agrees that it is their sole responsibility to determine suitability/fitness of the product described in this specification for their application and to take precautions for protection against any hazards attendant to the handling and use of the product.

Footnote:

GlobTek Inc. will not be liable for the safety and performance of these power supplies/battery packs if unauthorized access and repair occurs. End user should consult applicable UL, CSA or EN standards for proper installation instruction.

Limitation of Use:

GlobTek products are intended for use with commercial, medical, and/or industrial equipment only. GlobTek product are not authorized for use as mission critical components in life support hazardous environment, nuclear or aircraft applications without prior written approval from the CEO of GlobTek Inc.

Contents of this document are subject to change without prior notice.

Customer Approval of Specification:

Please approve, sign and send back to GlobTek so we can complete order processing.
A delay in receipt of this form will delay delivery schedule.

Company Name: _____	Customer P/N: _____
Quote Number: _____	Date: _____
Authorized Representative Name: _____	Authorized Representative Signature: _____

GlobTek, Inc. www.globtek.com 186 Veterans Drive, Northvale, NJ 07647 Tel. (201) 784-1000 Fax (201) 784-0111	Drawing Title: GTM46161-155.0-USB2C, ICT / ITE / Medical Power Supply, Efficiency Level: USA DOE Level VI / Eco-design Directive 2009/125/EC, (EU) 2019/1782, Case Color/Style: GlobTek White, Wall Plug-in, Regulated Switchmode AC-DC Power Supply AC Adaptor, Input Rating: 100-240V~, 50-60 Hz, Interchangeable Blades http://en.globtek.com/interchangeable-blades.php , Output Rating: 15W, 5.0V@3.0A, Output Configuration: N/A mm, N/A/4 Cond, N/A, Dual Type "C" USB "JACKS", integral to power supply enclosure compliant with Directive (EU) 2022/2380 and 2014/53/EU Radio Equipment Directive (RED), Ferrite: None, N/A, GT Cord # C69399, Pin Out: A1, A12, B1, B12: GND A4, A9, B4, B9: V+ CC1: A5 CC2: B5 D+: A6, B6 D-: A7, B7, Blades/Input Cord: White color, Approvals:	
	Model No. GTM46161-155.0-USB2C	
	Part No./Ordering No. WR9QA3000USBC2CNAIMR6W	Rev B

REVISION HISTORY

REV	DESCRIPTION	SUB	DATE	APPROVED
B	Update model family and engineering from GTM46161-155.0-USB2A to GTM46161-155.0-USB2C	QA	04/18/2023	QA
A1	Change Box Qty from "240Pcs" to "105 Pcs", Gift Box Size from "78*37*45mm" to "85*51*62mm", Master Carton Size from "465 x 415 x 225mm" to "440*375*225mm"	QA	03/13/2023	QA
A	Initial release	QA	10/20/2022	QA

POWER SUPPLY INFORMATION

TYPE	Wall Plug-in
TECHNOLOGY	Regulated Switchmode AC-DC Power Supply AC Adaptor
CASE COLOR	GlobTek White
NAMEPLATE RATED INPUT	100-240V~, 50-60 Hz, 0.45A
INPUT CONFIG	Interchangeable Blades
WATTS	15.00
VOLTS OUT	5.0
CURRENT OUT (Amps)	3.0
BLADE/CORD INCLUDED	Q-NA-WH(R) White color
INGRESS PROTECTION	Indoor Use
GROUNDING CONFIGURATION	(F1) Class II / Double Insulated
EFFICIENCY LEVEL	USA DOE Level VI / Eco-design Directive 2009/125/EC, (EU) 2019/1782
OUTPUT CONFIGURATION	N/A mm, N/A/4 Cond, N/A, Dual Type "C" USB "JACKS", integral to power supply enclosure compliant with Directive (EU) 2022/2380 and 2014/53/EU Radio Equipment Directive (RED), Ferrite: None, N/A, GT Cord # C69399
OVERMOLDED	No
OUTPUT CONNECTOR GENDER	not applicable
CONNECTOR PIN OUT	A1, A12, B1, B12: GND A4, A9, B4, B9: V+ CC1: A5 CC2: B5 D+: A6, B6 D-: A7, B7
LABEL SPECS	ISO 15223 medical device compliant label,L-1470
SPECIAL BARCODE LABEL MATERIAL	No
PACK SPEC	Standard with USB Jack, Individually Box, User manual
USER MANUAL	809-PSUQKITUSERMANUAL on A4 paper

PROPRIETARY INFORMATION

<p>GlobTek, Inc. www.globtek.com 186 Veterans Drive, Northvale, NJ 07647 Tel. (201) 784-1000 Fax (201) 784-0111</p>	<p>Drawing Title: GTM46161-155.0-USB2C, ICT / ITE / Medical Power Supply, Efficiency Level: USA DOE Level VI / Eco-design Directive 2009/125/EC, (EU) 2019/1782, Case Color/Style: GlobTek White, Wall Plug-in, Regulated Switchmode AC-DC Power Supply AC Adaptor, Input Rating: 100-240V~, 50-60 Hz, Interchangeable Blades http://en.globtek.com/interchangeable-blades.php, Output Rating: 15W, 5.0V@3.0A, Output Configuration: N/A mm, N/A/4 Cond, N/A, Dual Type "C" USB "JACKS", integral to power supply enclosure compliant with Directive (EU) 2022/2380 and 2014/53/EU Radio Equipment Directive (RED), Ferrite: None, N/A, GT Cord # C69399, Pin Out: A1, A12, B1, B12: GND A4, A9, B4, B9: V+ CC1: A5 CC2: B5 D+: A6, B6 D-: A7, B7, Blades/Input Cord: White color, Approvals:</p>
	<p>Model No. GTM46161-155.0-USB2C</p>
	<p>Part No./Ordering No. WR9QA3000USBC2CNAIMR6W</p>
	<p>Rev B</p>

Notes/Modifications/Customizations (notes in this section supersede the values shown in the standard spec)
DIMENSIONS ARE IN MM UNLESS SPECIFIED OTHERWISE

GloTek, Inc. www.globtek.com 186 Veterans Drive, Northvale, NJ 07647 Tel. (201) 784-1000 Fax (201) 784-0111	Drawing Title: GTM46161-155.0-USB2C, ICT / ITE / Medical Power Supply, Efficiency Level: USA DOE Level VI / Eco-design Directive 2009/125/EC, (EU) 2019/1782, Case Color/Style: GlobTek White, Wall Plug-in, Regulated Switchmode AC-DC Power Supply AC Adaptor, Input Rating: 100-240V~, 50-60 Hz, Interchangeable Blades http://en.globtek.com/interchangeable-blades.php , Output Rating: 15W, 5.0V@3.0A, Output Configuration: N/A mm, N/A/4 Cond, N/A, Dual Type "C" USB "JACKS", integral to power supply enclosure compliant with Directive (EU) 2022/2380 and 2014/53/EU Radio Equipment Directive (RED), Ferrite: None, N/A, GT Cord # C69399, Pin Out: A1, A12, B1, B12: GND A4, A9, B4, B9: V+ CC1: A5 CC2: B5 D+: A6, B6 D-: A7, B7, Blades/Input Cord: White color, Approvals:	
	Model No. GTM46161-155.0-USB2C	
	Part No./Ordering No. WR9QA3000USBC2CNAIMR6W	Rev B

ELECTRICAL SPECIFICATIONS

A) ELECTRICAL SPECIFICATIONS:

1. Input Voltage: Specified 90-264 V_{AC}, Nameplate rated 100-240 V_{AC}
2. Input Frequency: Specified 47-63 Hz, Nameplate rated 50-60 Hz
3. Output Regulation: ±5% measured at the end of a 1.2 meter USB cordset employing 20AWG conductors (RFP RFI-50856)
4. Line Voltage Regulation: ±3% (typical)
5. Output Ripple (V_{P-P}): 150mV, measured with a 47µF electrolytic capacitor in parallel with a 0.1µF ceramic capacitor across the output, and 20MHz bandwidth limiting
6. Turn-On/Turn-Off Overshoot: 5% maximum, 500µs maximum recovery time for 25% step load.
7. Turn-On Delay: 3000ms (max.) @ 115V_{AC} and full load
8. Hold-Up Time: 8ms (min.) @ 100V_{AC} and full load
9. Inrush Current: No damage when switching on/off repeatedly under any condition
10. Switching Frequency: 66.5 KHz (typical)
11. Average Efficiency: 78.7% (min.) (CEC&DOE Level VI Compliant), 79.0% (min.) (ErP European Commission's Ecodesign Directive (2005/32/EC) / CoC Tier 2 Compliant)
12. No-Load Input Power: < 0.1W < 0.1W, < 0.075W (ErP European Commission's Ecodesign Directive (2005/32/EC) / CoC Tier 2 Compliant)

B) PROTECTION

1. Over-Voltage: Output shut down and auto restart
2. Over Temperature Protection: Output shut down and auto restart
3. Short Circuit Protection Output shut down and auto restart
4. Over Load Protection Output shut down and auto restart
5. Input Protection: Input line fusing
6. ESD: 8 kV Contact/20kV Air Discharge

C) SAFETY

1. Dielectric Withstand Voltage: 4000V_{AC} or 5656V_{DC} 10mA 1 minute
2. Earth Leakage Current: N/A for Class II units. Since there is no PE ground pin, earth leakage current is not measured
3. Touch Current: Maximum allowed values: 100µA NC(Normal Condition) 500µA SFC(Single Fault Condition)
4. Means of Protection: 2 x MOPP
5. ROHS 2: Complies with EU 2011/65/EU and China SJ/T 11363-2006

PROPRIETARY INFORMATION

PROPRIETARY OF GLOBTEK, INC. ANY REPRODUCTION, DISCLOSURE OR USE OF THIS DRAWING, IN WHOLE OR IN PART, IS HEREBY PROHIBITED EXCEPT AS SPECIFIED IN WRITING BY GLOBTEK, INC. © GlobTek, Inc. 2022 - 2023

GlobTek, Inc. www.globtek.com 186 Veterans Drive, Northvale, NJ 07647 Tel. (201) 784-1000 Fax (201) 784-0111	Drawing Title: GTM46161-155.0-USB2C, ICT / ITE / Medical Power Supply, Efficiency Level: USA DOE Level VI / Eco-design Directive 2009/125/EC, (EU) 2019/1782, Case Color/Style: GlobTek White, Wall Plug-in, Regulated Switchmode AC-DC Power Supply AC Adaptor, Input Rating: 100-240V~, 50-60 Hz, Interchangeable Blades http://en.globtek.com/interchangeable-blades.php , Output Rating: 15W, 5.0V@3.0A, Output Configuration: N/A mm, N/A/4 Cond, N/A, Dual Type "C" USB "JACKS", integral to power supply enclosure compliant with Directive (EU) 2022/2380 and 2014/53/EU Radio Equipment Directive (RED), Ferrite: None, N/A, GT Cord # C69399, Pin Out: A1, A12, B1, B12: GND A4, A9, B4, B9: V+ CC1: A5 CC2: B5 D+: A6, B6 D-: A7, B7, Blades/Input Cord: White color, Approvals:	
	Model No. GTM46161-155.0-USB2C	
	Part No./Ordering No. WR9QA3000USBC2CNAIMR6W	Rev B

D) EMC

1. Emissions, per EN 55032, EN 61000-6-3, EN 61000-6-4 (See Note.)

Conducted Emissions: Class B, FCC Part 15, Class B

Radiated Emissions: Class B, FCC Part 15, Class B

2. Line Frequency Harmonics EN61000-3-2, Class A

3. Voltage Fluctuations/Flicker EN61000-3-3

4. Immunity, per EN 55024, EN 61000-6-1, EN 61000-6-2

Static Discharge Immunity EN61000-4-2, 8KV Contact Discharge, 15KV air discharge

Radiated RF Immunity EN61000-4-3, 3V/m 80-2700MHz, 80% 1KHz AM.

EFT/Burst Immunity EN61000-4-4, 2KV/100kHz.

Line Surge Immunity EN61000-4-5, 1KV differential, 2KV common-mode

Conducted RF Immunity EN61000-4-6, 3V_{RMS}, 80% 1KHz AM

Power Frequency Magnetic Field Immunity EN61000-4-8, NA

Voltage Dip Immunity EN61000-4-11, Criteria

Note: When a Class II power supply is connected to an earth-referenced system, conducted/radiated EMI levels tend to increase since the earth connection creates a return path for common-mode currents.

This model includes an output common-mode choke to help alleviate system-level EMI issues. This choke can also be removed to lower product cost .

E) OTHER:

1. USB2.0 , BC1.2 compliant

2. MTBF: 200,000 hours @ 25°C ambient temperature

3. Operating Temperature: 0°C to 40°C ambient temperature

4. Humidity: 0% to 95% relative humidity

5. Storage Temperature: -40°C to 80°C

F) ENCLOSURE

1. Housing: High impact plastic, 94V0 polycarbonate, non-vented

2. Markings: Label and/or Pad Printed and/or Molded in the case

<p>GlobTek, Inc. www.globtek.com 186 Veterans Drive, Northvale, NJ 07647 Tel. (201) 784-1000 Fax (201) 784-0111</p>	<p>Drawing Title: GTM46161-155.0-USB2C, ICT / ITE / Medical Power Supply, Efficiency Level: USA DOE Level VI / Eco-design Directive 2009/125/EC, (EU) 2019/1782, Case Color/Style: GlobTek White, Wall Plug-in, Regulated Switchmode AC-DC Power Supply AC Adaptor, Input Rating: 100-240V~, 50-60 Hz, Interchangeable Blades http://en.globtek.com/interchangeable-blades.php, Output Rating: 15W, 5.0V@3.0A, Output Configuration: N/A mm, N/A/4 Cond, N/A, Dual Type "C" USB "JACKS", integral to power supply enclosure compliant with Directive (EU) 2022/2380 and 2014/53/EU Radio Equipment Directive (RED), Ferrite: None, N/A, GT Cord # C69399, Pin Out: A1, A12, B1, B12: GND A4, A9, B4, B9: V+ CC1: A5 CC2: B5 D+: A6, B6 D-: A7, B7, Blades/Input Cord: White color, Approvals:</p>
	<p>Model No. GTM46161-155.0-USB2C</p>
	<p>Part No./Ordering No. WR9QA3000USBC2CNAIMR6W</p>
	<p>Rev B</p>

TO ADDRESS SYSTEM-LEVEL EMI CONCERNS, FERRITE CHOKES/BEADS MAY BE ADDED/REVISED UPON REQUEST. A SAMPLE KIT OF GLOBTEK'S STANDARD FERRITES IS AVAILABLE UNDER GLOBTEK P/N: EMI-MITIGATION-KIT1

FOR ADDITIONAL INFORMATION, PLEASE READ OUR WHITE PAPER AT: <https://r.globtek.info/3QeaqtD>

INGRESS PROTECTION: Indoor Use

<p>GlobTek, Inc. www.globtek.com 186 Veterans Drive, Northvale, NJ 07647 Tel. (201) 784-1000 Fax (201) 784-0111</p>	<p>Drawing Title: GTM46161-155.0-USB2C, ICT / ITE / Medical Power Supply, Efficiency Level: USA DOE Level VI / Eco-design Directive 2009/125/EC, (EU) 2019/1782, Case Color/Style: GlobTek White, Wall Plug-in, Regulated Switchmode AC-DC Power Supply AC Adaptor, Input Rating: 100-240V~, 50-60 Hz, Interchangeable Blades http://en.globtek.com/interchangeable-blades.php, Output Rating: 15W, 5.0V@3.0A, Output Configuration: N/A mm, N/A/4 Cond, N/A, Dual Type "C" USB "JACKS", integral to power supply enclosure compliant with Directive (EU) 2022/2380 and 2014/53/EU Radio Equipment Directive (RED), Ferrite: None, N/A, GT Cord # C69399, Pin Out: A1, A12, B1, B12: GND A4, A9, B4, B9: V+ CC1: A5 CC2: B5 D+: A6, B6 D-: A7, B7, Blades/Input Cord: White color, Approvals:</p>
	<p>Model No. GTM46161-155.0-USB2C</p>
	<p>Part No./Ordering No. WR9QA3000USBC2CNAIMR6W Rev B</p>

3D File Download https://www.globtek.com/dl/gtm46161-16vv-usb2a_asm.stp

Mechanical drawing

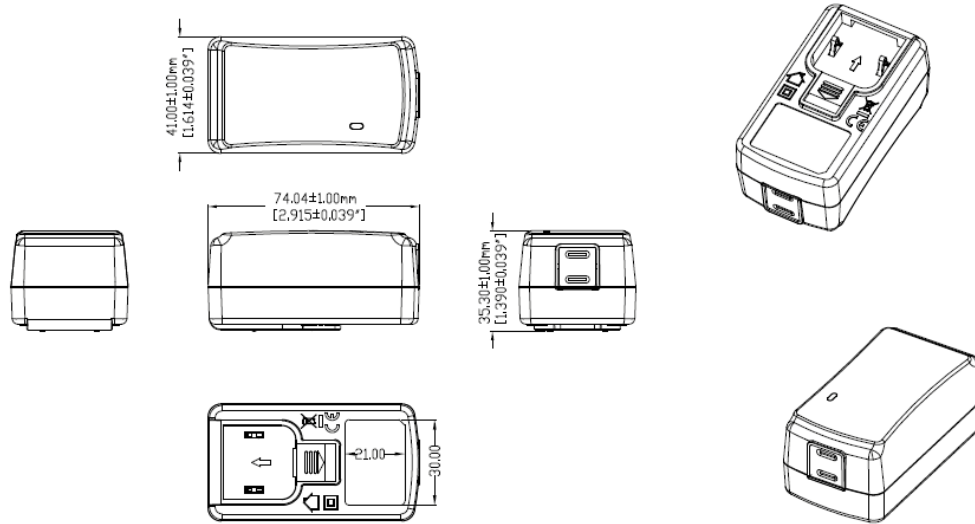

10K resistor between CC1 (A5) and VCC (A4)

Link to Globtek USB-C Adaptive Power Delivery White Paper

<http://en.globtek.com/technical-articles/usb-type-c-connectors-and-adaptive-power-delivery-white-paper>

GlobTek, Inc.
 www.globtek.com
 186 Veterans Drive,
 Northvale, NJ 07647
 Tel. (201) 784-1000
 Fax (201) 784-0111

Drawing Title: GTM46161-155.0-USB2C, ICT / ITE / Medical Power Supply, Efficiency Level: USA DOE Level VI / Eco-design Directive 2009/125/EC, (EU) 2019/1782, Case Color/Style: GlobTek White, Wall Plug-in, Regulated Switchmode AC-DC Power Supply AC Adaptor, Input Rating: 100-240V~, 50-60 Hz, Interchangeable Blades <http://en.globtek.com/interchangeable-blades.php>, Output Rating: 15W, 5.0V@3.0A, Output Configuration: N/A mm, N/A/4 Cond, N/A, Dual Type "C" USB "JACKS", integral to power supply enclosure compliant with Directive (EU) 2022/2380 and 2014/53/EU Radio Equipment Directive (RED), Ferrite: None, N/A, GT Cord # C69399, Pin Out: A1, A12, B1, B12: GND A4, A9, B4, B9: V+ CC1: A5 CC2: B5 D+: A6, B6 D-: A7, B7, Blades/Input Cord: White color, Approvals:

Model No. GTM46161-155.0-USB2C

Part No./Ordering No. WR9QA3000USBC2CNAIMR6W

Rev B

DERATING CURVE

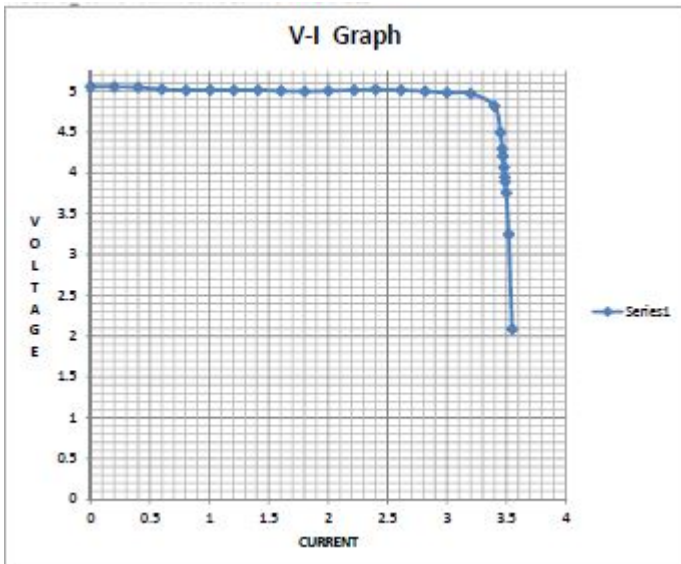
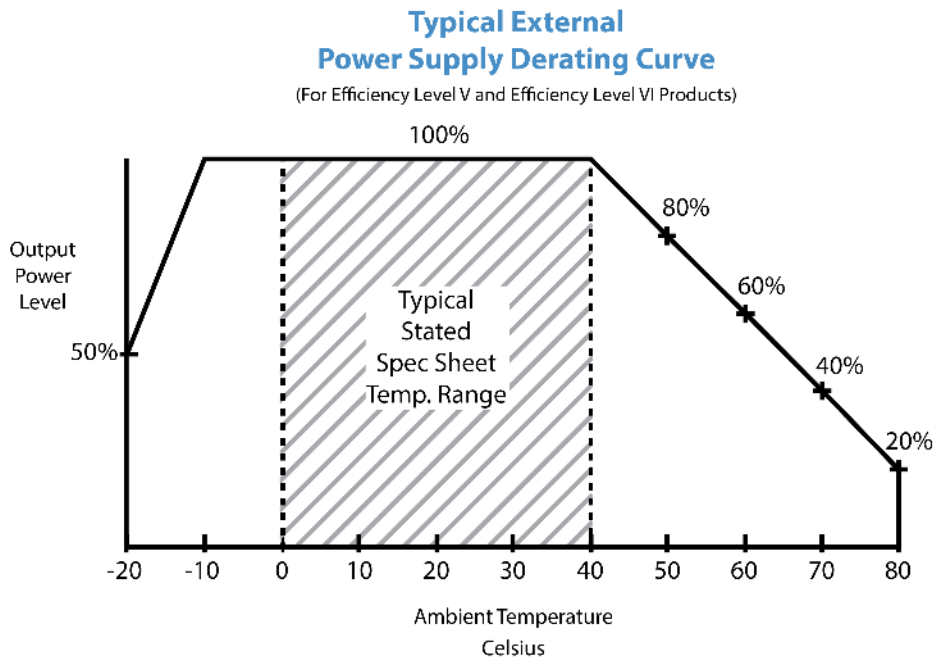

PROPRIETARY INFORMATION

PROPRIETARY OF GLOBTEK, INC. ANY REPRODUCTION, DISCLOSURE OR USE OF THIS DRAWING, IN WHOLE OR IN PART, IS HEREBY PROHIBITED EXCEPT AS SPECIFIED IN WRITING BY GLOBTEK, INC. © GlobTek, Inc. 2022 - 2023

GlobTek, Inc. www.globtek.com 186 Veterans Drive, Northvale, NJ 07647 Tel. (201) 784-1000 Fax (201) 784-0111	Drawing Title: GTM46161-155.0-USB2C, ICT / ITE / Medical Power Supply, Efficiency Level: USA DOE Level VI / Eco-design Directive 2009/125/EC, (EU) 2019/1782, Case Color/Style: GlobTek White, Wall Plug-in, Regulated Switchmode AC-DC Power Supply AC Adaptor, Input Rating: 100-240V~, 50-60 Hz, Interchangeable Blades http://en.globtek.com/interchangeable-blades.php , Output Rating: 15W, 5.0V@3.0A, Output Configuration: N/A mm, N/A/4 Cond, N/A, Dual Type "C" USB "JACKS", integral to power supply enclosure compliant with Directive (EU) 2022/2380 and 2014/53/EU Radio Equipment Directive (RED), Ferrite: None, N/A, GT Cord # C69399, Pin Out: A1, A12, B1, B12: GND A4, A9, B4, B9: V+ CC1: A5 CC2: B5 D+: A6, B6 D-: A7, B7, Blades/Input Cord: White color, Approvals:	
	Model No. GTM46161-155.0-USB2C	
	Part No./Ordering No. WR9QA3000USBC2CNAIMR6W	Rev B

INPUT CONFIGURATION

(F1) Class II / Double Insulated



[Alternate grounding configurations](#) available upon request.

Blades/Cord Included:Q-NA-WH(R):White color

Blade Options for Q Series Wall Plug-in Power Supplies

Data Sheet: <http://en.globtek.com/interchangeable-blades.php>

Insertion Instructions: <http://www.globtek.com/pdf/Instructions-Interchangeable-Blades.pdf>

Video: [Q-Blade Style Instruction Video](#)

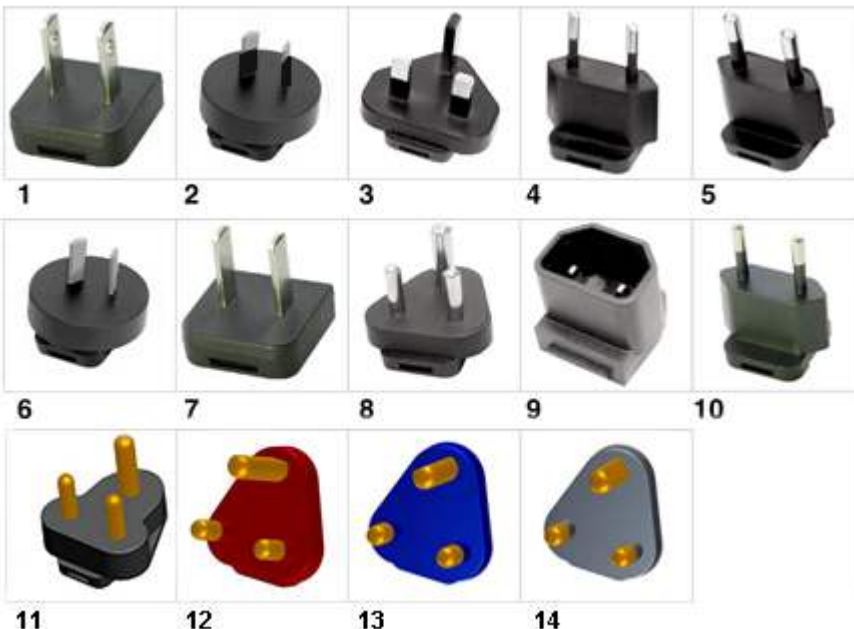

PROPRIETARY INFORMATION

GlobTek, Inc. www.globtek.com 186 Veterans Drive, Northvale, NJ 07647 Tel. (201) 784-1000 Fax (201) 784-0111	Drawing Title: GTM46161-155.0-USB2C, ICT / ITE / Medical Power Supply, Efficiency Level: USA DOE Level VI / Eco-design Directive 2009/125/EC, (EU) 2019/1782, Case Color/Style: GlobTek White, Wall Plug-in, Regulated Switchmode AC-DC Power Supply AC Adaptor, Input Rating: 100-240V~, 50-60 Hz, Interchangeable Blades http://en.globtek.com/interchangeable-blades.php , Output Rating: 15W, 5.0V@3.0A, Output Configuration: N/A mm, N/A/4 Cond, N/A, Dual Type "C" USB "JACKS", integral to power supply enclosure compliant with Directive (EU) 2022/2380 and 2014/53/EU Radio Equipment Directive (RED), Ferrite: None, N/A, GT Cord # C69399, Pin Out: A1, A12, B1, B12: GND A4, A9, B4, B9: V+ CC1: A5 CC2: B5 D+: A6, B6 D-: A7, B7, Blades/Input Cord: White color, Approvals:	
	Model No. GTM46161-155.0-USB2C	
	Part No./Ordering No. WR9QA3000USBC2CNAIMR6W	Rev B

INPUT CONNECTOR: Q-Socket (below are available blades configurations which are "not included" (unless stated above); can be purchased separately, package with power supply or as a separate "Q-KIT" if specified

01. United States / Canada / Japan NEMA 1-15P/ IEC PLUG Type A [WORKS IN PLUG B] configuration: NA 2 blades, Class II; US/CA/JP P/N: Q-NA(R)
02. Australian AS 3112 configuration: SAA 2 blade/ IEC TYPE I, Class II; AU P/N: Q-SAA(R)
03. UK BS 1363 configuration: UK 3 blade with dummy Ground/ IEC TYPE G, Class II; GB P/N: Q-UK(R)
04. European CEE 7/16 configuration: Europlug 2 pins/ IEC TYPE C [WORKS IN TYPE E&F], Class II; EU P/N: Q-EU(R)
05. Korean KS C8305 configuration: 2 pins/SIMILAR TO IEC TYPE C, Class II; KR P/N: Q-KR(R)
06. Argentina IRAM 2073 configuration: 2 blades/SIMILAR TO IEC TYPE I; AR P/N: Class II Q-AR(R)
07. China GB 2099 configuration: 2 blades/SIMILAR TO TYPE A, Class II; CN P/N:Q-CN(R)
08. India IS 1293 6A/BS546 configuration: 5A, 3 pins with Dummy Ground, Class II/IEC TYPE D; IN P/N: Q-IN(R)
09. IEC60320/C18 Inlet, Class II; P/N: Q-C18(R)
10. Brazilian NBR6147 configuration: 2 pins, Class II;SIMILAR TO IEC TYPE C BR P/N: Q-BR(R)
11. South Africa SABS164-1 and India IS 1293, IS694, 16A type plug, 3 round prongs, Class II + dummy ground, IEC TYPE M P/N: Q-SANS164-1-16A(R)
12. South Africa SABS164-4, 3 round prongs with a notched prong @ 0°, Class II + dummy ground, IEC TYPE M Red, P/N: Q-SANS164-4C-16A(R)
13. South Africa SABS164-4, 3 round prongs with a notched prong @ -53°, Class II + dummy ground, Blue, IEC TYPE M, P/N: Q-SANS164-4L-16A(R)
14. South Africa SABS164-4, 3 round prongs with a notched prong @ +53°, Class II + dummy ground, Black,IEC TYPE M P/N: Q-SANS164-4R-16A(R)

Kits

01. Q-KIT: 1,2,3,4 above
02. Q-KIT-INTL: 2,3,4 above
03. Q-KIT-6: 1,2,3,4,5,6 above
04. Q-KIT-7: 1,2,3,4,5,6,7 above
05. Q-KIT-8: 1,2,3,4,5,6,7,8 above

PROPRIETARY INFORMATION

GloTek, Inc. www.globtek.com 186 Veterans Drive, Northvale, NJ 07647 Tel. (201) 784-1000 Fax (201) 784-0111	Drawing Title: GTM46161-155.0-USB2C, ICT / ITE / Medical Power Supply, Efficiency Level: USA DOE Level VI / Eco-design Directive 2009/125/EC, (EU) 2019/1782, Case Color/Style: GlobTek White, Wall Plug-in, Regulated Switchmode AC-DC Power Supply AC Adaptor, Input Rating: 100-240V~, 50-60 Hz, Interchangeable Blades http://en.globtek.com/interchangeable-blades.php , Output Rating: 15W, 5.0V@3.0A, Output Configuration: N/A mm, N/A/4 Cond, N/A, Dual Type "C" USB "JACKS", integral to power supply enclosure compliant with Directive (EU) 2022/2380 and 2014/53/EU Radio Equipment Directive (RED), Ferrite: None, N/A, GT Cord # C69399, Pin Out: A1, A12, B1, B12: GND A4, A9, B4, B9: V+ CC1: A5 CC2: B5 D+: A6, B6 D-: A7, B7, Blades/Input Cord: White color, Approvals:	
	Model No. GTM46161-155.0-USB2C	
	Part No./Ordering No. WR9QA3000USBC2CNAIMR6W	Rev B

OUTPUT CORD AND CONNECTOR: USBC2/C69399

ACTUAL CONNECTORS, OVERMOLDS, FERRITES MAY VARY SLIGHTLY FROM THE PICTURE BELOW

CABLE TYPE	N/A
CABLE LENGTH (mm)	N/A
CABLE TOLERANCE (mm)	N/A
WIRE GAUGE (AWG)	N/A
CONDUCTORS	4
HANK DIMENSION (mm)	N/A
CABLE / CONNECTOR OVERMOLD COLOR	N/A
FERRITE TYPE AND DIMENSION	None
FERRITE NUMBER OF TURNS (Definition)	N/A
FERRITE DIMENSION FROM STRAIN RELIEF	N/A
FERRITE DIMENSION FROM PLUG	N/A
PLUG TYPE	Dual Type "C" USB "JACKS", integral to power supply enclosure compliant with Directive (EU) 2022/2380 and 2014/53/EU Radio Equipment Directive (RED)
OUTPUT CONNECTOR GENDER	not applicable
OVERMOLDED	No
OVER MOLD ORIENTATION	PCB Mount Connector
CONNECTOR PIN OUT	A1, A12, B1, B12: GND A4, A9, B4, B9: V+ CC1: A5 CC2: B5 D+: A6, B6 D-: A7, B7

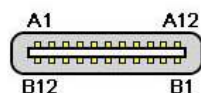
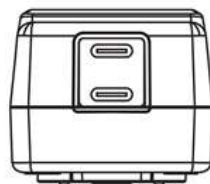

ADDITIONAL OUTPUT PLUG OPTIONS ARE AVAILABLE AT <https://www.globtek.com/connectors/>
STANDARD PLUGS AND CONNECTORS CAN BE SEEN ONLINE AT <https://www.globtek.com/connectors/>
CALCULATE VOLTAGE REGULATION/DROP WITH OUR ONLINE CALCULATOR: <https://en.globtek.com/output-cable-regulation-calculator/>

<p>GlobTek, Inc. www.globtek.com 186 Veterans Drive, Northvale, NJ 07647 Tel. (201) 784-1000 Fax (201) 784-0111</p>	<p>Drawing Title: GTM46161-155.0-USB2C, ICT / ITE / Medical Power Supply, Efficiency Level: USA DOE Level VI / Eco-design Directive 2009/125/EC, (EU) 2019/1782, Case Color/Style: GlobTek White, Wall Plug-in, Regulated Switchmode AC-DC Power Supply AC Adaptor, Input Rating: 100-240V~, 50-60 Hz, Interchangeable Blades http://en.globtek.com/interchangeable-blades.php, Output Rating: 15W, 5.0V@3.0A, Output Configuration: N/A mm, N/A/4 Cond, N/A, Dual Type "C" USB "JACKS", integral to power supply enclosure compliant with Directive (EU) 2022/2380 and 2014/53/EU Radio Equipment Directive (RED), Ferrite: None, N/A, GT Cord # C69399, Pin Out: A1, A12, B1, B12: GND A4, A9, B4, B9: V+ CC1: A5 CC2: B5 D+: A6, B6 D-: A7, B7, Blades/Input Cord: White color, Approvals:</p>
	<p>Model No. GTM46161-155.0-USB2C</p>
	<p>Part No./Ordering No. WR9QA3000USBC2CNAIMR6W Rev B</p>

OUTPUT CONNECTOR HOOK UP

TO ADDRESS SYSTEM-LEVEL EMI CONCERNS, FERRITE CHOKES/BEADS MAY BE ADDED/REVISED UPON REQUEST. A SAMPLE KIT OF GLOBTEK'S STANDARD FERRITES IS AVAILABLE UNDER GLOBTEK P/N: EMI-MITIGATION-KIT1

FOR ADDITIONAL INFORMATION, PLEASE READ OUR WHITE PAPER AT:

<https://en.globtek.com/technical-articles/ferrite-kit-radiated-emi-suppression-kit-for-globtek-power-supplies-cable-assemblies>

GloTek, Inc. www.globtek.com 186 Veterans Drive, Northvale, NJ 07647 Tel. (201) 784-1000 Fax (201) 784-0111	Drawing Title: GTM46161-155.0-USB2C, ICT / ITE / Medical Power Supply, Efficiency Level: USA DOE Level VI / Eco-design Directive 2009/125/EC, (EU) 2019/1782, Case Color/Style: GlobTek White, Wall Plug-in, Regulated Switchmode AC-DC Power Supply AC Adaptor, Input Rating: 100-240V~, 50-60 Hz, Interchangeable Blades http://en.globtek.com/interchangeable-blades.php, Output Rating: 15W, 5.0V@3.0A, Output Configuration: N/A mm, N/A/4 Cond, N/A, Dual Type "C" USB "JACKS", integral to power supply enclosure compliant with Directive (EU) 2022/2380 and 2014/53/EU Radio Equipment Directive (RED), Ferrite: None, N/A, GT Cord # C69399, Pin Out: A1, A12, B1, B12: GND A4, A9, B4, B9: V+ CC1: A5 CC2: B5 D+: A6, B6 D-: A7, B7, Blades/Input Cord: White color, Approvals:	
	Model No. GTM46161-155.0-USB2C	
	Part No./Ordering No. WR9QA3000USBC2CNAIMR6W	Rev B

LABEL:L-1470

LABEL P/N	ISO 15223 medical device compliant label
MATERIAL	Flat Thermal Transfer, Imprintable, Polyester Label and/or Pad Printed and/or Molded, and/or Laser Engraved in the case
BACKGROUND COLOR	Black if housing is Black, White or Silver if housing is White or Gray.
TEXT COLOR	White or Silver if label is Black Background for Black housing. Black if label is White or Silver background and Housing is White or Gray.
LABEL WIDTH (mm)	28.5
LABEL HEIGHT (mm)	17.5
SPECIAL BARCODE LABEL MATERIAL	No

Below is the minimum information which will appear on the label. NOTE: in the logo area additional/actual positioning of symbols and text is subjected to change as per agency updates/requirements or additional model approvals become available. Agency logos may be in Regulatory Certifications/Label Markings area on the label or molded into the case housing outside the label area. Information will be shown via Label and/or Pad Printed and/or Molded in the case.

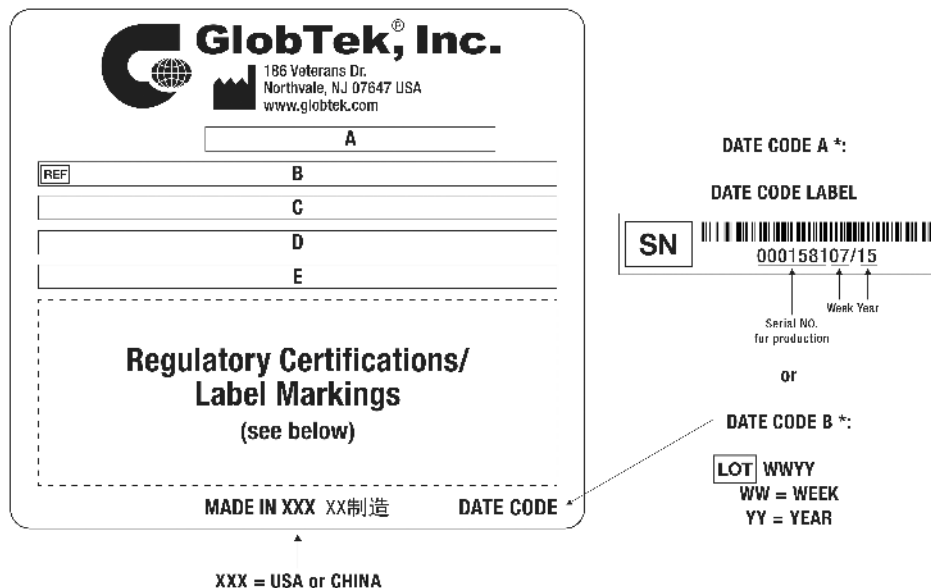

- A=ICT / ITE / Medical Power Supply
- B=P/N: (料号) WR9QA3000USBC2CNAIMR6W
- C=Model (型号) GTM46161-155.0-USB2C
- D=Input (输入)100-240V~, 50-60 Hz, 0.45A
- E=Output (输出)5.0 V 3.0 A, 15.00W

GloTek, Inc. www.globtek.com 186 Veterans Drive, Northvale, NJ 07647 Tel. (201) 784-1000 Fax (201) 784-0111	Drawing Title: GTM46161-155.0-USB2C, ICT / ITE / Medical Power Supply, Efficiency Level: USA DOE Level VI / Eco-design Directive 2009/125/EC, (EU) 2019/1782, Case Color/Style: GlobTek White, Wall Plug-in, Regulated Switchmode AC-DC Power Supply AC Adaptor, Input Rating: 100-240V~, 50-60 Hz, Interchangeable Blades http://en.globtek.com/interchangeable-blades.php , Output Rating: 15W, 5.0V@3.0A, Output Configuration: N/A mm, N/A/4 Cond, N/A, Dual Type "C" USB "JACKS", integral to power supply enclosure compliant with Directive (EU) 2022/2380 and 2014/53/EU Radio Equipment Directive (RED), Ferrite: None, N/A, GT Cord # C69399, Pin Out: A1, A12, B1, B12: GND A4, A9, B4, B9: V+ CC1: A5 CC2: B5 D+: A6, B6 D-: A7, B7, Blades/Input Cord: White color, Approvals:	
	Model No. GTM46161-155.0-USB2C	
	Part No./Ordering No. WR9QA3000USBC2CNAIMR6W	Rev B

AGENCY ONLINE DOCUMENTS	http://www.globtek.info/certs/GTM46161%20-1A,2A,C/
CE EC-Declaration for Medical	http://globtek.force.com/models/ec_declaration_product?id=01t3a000005gbKg&m=1
CE EC-Declaration for Industrial/Commercial/ITE	http://globtek.force.com/models/ec_declaration_product?id=01t3a000005gbKg&i=2
CE EC-Declaration for Household	Contact GlobTek for more information
UKCA-Declaration for Medical	http://globtek.force.com/models/ukca_declaration_product?id=01t3a000005gbKg&m=1
UKCA-Declaration for Industrial/Commercial/ITE	http://globtek.force.com/models/ukca_declaration_product?id=01t3a000005gbKg&i=2
UKCA-Declaration for Household	Contact GlobTek for more information
Morocco SDoC Declaration	https://globtek.secure.force.com/models/Morocco_SDoC_Declaration?id=a0O3a00000MviahEAB
RoHS/RoHS3 Declaration	https://www.globtek.com/pdf/rohs_cert/01t3a000005gbKgAAI
REACH Declaration	https://www.globtek.com/pdf/iso_certificates/REACH.pdf
Conflict Minerals Declaration	https://www.globtek.com/pdf/conflict-minerals.pdf
Prop 65 Statement	https://en.globtek.com/prop-65-statement.pdf
IPXY rating is based on 3rd party testing and customers should check suitability and test system level IPXY rating before ordering.	

Regulatory Certifications/Label Markings

Below follows a link to the latest regulatory certifications and marks for this specific product. National standards as well as certification schemes are constantly changing and so is the set of certification marks and symbols applicable to this product. Various standards, marks and symbols, and certificates are subject to change at any time without notice.

Additional standards or unique country certifications are available upon request. Please contact Globtek to request a quotation.

LATEST PRODUCT/MODEL CERTIFICATIONS: <https://www.globtek.com/datasheet/Y93398696>

AGENCY ONLINE DOCUMENTS <http://www.globtek.info/certs/GTM46161%20-1A,2A,C/>



(F1) Class II / Double Insulated

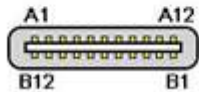

- A1, A12, B1, B12: GND
- A4, A9, B4, B9: V+
- CC1: A5
- CC2: B5
- D+: A6, B6
- D-: A7, B7

GloTek, Inc. www.globtek.com 186 Veterans Drive, Northvale, NJ 07647 Tel. (201) 784-1000 Fax (201) 784-0111	Drawing Title: GTM46161-155.0-USB2C, ICT / ITE / Medical Power Supply, Efficiency Level: USA DOE Level VI / Eco-design Directive 2009/125/EC, (EU) 2019/1782, Case Color/Style: GlobTek White, Wall Plug-in, Regulated Switchmode AC-DC Power Supply AC Adaptor, Input Rating: 100-240V~, 50-60 Hz, Interchangeable Blades http://en.globtek.com/interchangeable-blades.php , Output Rating: 15W, 5.0V@3.0A, Output Configuration: N/A mm, N/A/4 Cond, N/A, Dual Type "C" USB "JACKS", integral to power supply enclosure compliant with Directive (EU) 2022/2380 and 2014/53/EU Radio Equipment Directive (RED), Ferrite: None, N/A, GT Cord # C69399, Pin Out: A1, A12, B1, B12: GND A4, A9, B4, B9: V+ CC1: A5 CC2: B5 D+: A6, B6 D-: A7, B7, Blades/Input Cord: White color, Approvals:	
	Model No. GTM46161-155.0-USB2C	
	Part No./Ordering No. WR9QA3000USBC2CNAIMR6W	Rev B

PACKAGING

Packing Spec P/N	Standard with USB Jack, Individually Box, User manual
Box Qty	105
Gift Box Size (mm)	85*51*62
Gift Box Color	White
Master Carton Size (mm)	440 x 375 x 225
Master Carton Cubic Volume (m ³)	0.04
Master GW (Kg)	14.8 kg
BLADES INCLUDED	Q-NA-WH(R): White color
BLADE/CORD INSTALLED	:
USER MANUAL*	809-PSUQKITUSERMANUAL on A4 paper
USER MANUAL WEB LINK	https://en.globtek.com/pdf/809-PSUQKITUSERMANUAL.jpg

* This specification sheet is considered the user manual for all applications. It is expected that the buyer of this product will use it to formulate their own user manual for their end product and a user manual specifically for the power adapter is not usually required. If a user manual is not specifically listed above then none will be provided with this unit.

If specific packaging is required, this section must specify all requirements and note "no exceptions". If this section does not specify packaging, it is subject to change without notice at GlobTek's discretion

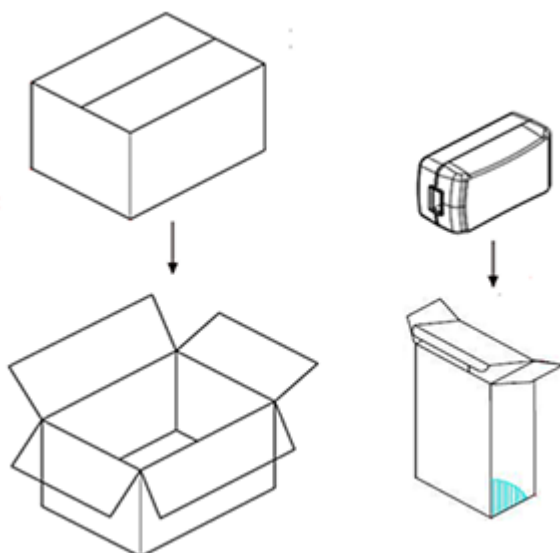

PROPRIETARY INFORMATION

GloTek, Inc. www.globtek.com 186 Veterans Drive, Northvale, NJ 07647 Tel. (201) 784-1000 Fax (201) 784-0111	Drawing Title: GTM46161-155.0-USB2C, ICT / ITE / Medical Power Supply, Efficiency Level: USA DOE Level VI / Eco-design Directive 2009/125/EC, (EU) 2019/1782, Case Color/Style: GlobTek White, Wall Plug-in, Regulated Switchmode AC-DC Power Supply AC Adaptor, Input Rating: 100-240V~, 50-60 Hz, Interchangeable Blades http://en.globtek.com/interchangeable-blades.php , Output Rating: 15W, 5.0V@3.0A, Output Configuration: N/A mm, N/A/4 Cond, N/A, Dual Type "C" USB "JACKS", integral to power supply enclosure compliant with Directive (EU) 2022/2380 and 2014/53/EU Radio Equipment Directive (RED), Ferrite: None, N/A, GT Cord # C69399, Pin Out: A1, A12, B1, B12: GND A4, A9, B4, B9: V+ CC1: A5 CC2: B5 D+: A6, B6 D-: A7, B7, Blades/Input Cord: White color, Approvals:	
	Model No. GTM46161-155.0-USB2C	
	Part No./Ordering No. WR9QA3000USBC2CNAIMR6W	Rev B

INSTRUCTIONS TO THE OEM SYSTEMS ENGINEER

It is the responsibility of the OEM systems engineer to provide the end system user instructions and warnings for the use of this product in the end system.

If an input cord is required for this product, AC Mains voltage should be provided to the power supply by a power supply cord approved to the national standards of the country in which it will be used.

This product is not designed to be repaired. No serviceable parts inside. A blown internal fuse is an indication of catastrophic failure of circuit component(s). If a Failure Analysis is required for a failed power supply/battery charger, please return the damaged unit to GlobTek for an accurate determination of the root cause of the failure.

EMC Compliance of the complete OEM product, including the GlobTek power supply/battery charger needs to be verified by the OEM systems engineer.

INSTRUCTION SHEET

Q Blades Instruction Sheet (not required to be packaged with product)

Insertion Instructions: <http://www.globtek.com/pdf/Instructions-Interchangeable-Blades.pdf>

This manual is Provided to customer within the product specification - it is the responsibility of the OEM/customer to provide the end system user instructions + warnings for the use of this product in the end system. By accepting this specification the customer/OEM Agrees to these terms.

USER MANUAL FOR Q-BLADE SERIES SWITCHING POWER SUPPLIES

Manual del Usuario. Fuentes de Alimentación Series Q-Blade

WARNING! RISK OF FIRE! SHOCK HAZARD!: To prevent electric shock, do not remove the cover. No user-serviceable parts inside. This unit contains hazardous voltages and should only be opened by a trained and qualified technician. Do not use if bent, cracked, modified or compromised. To avoid the possibility of electric shock, disconnect electric power to the product before connecting or disconnecting.

Advertencia! Riesgo de Fuego! Peligro de Choque eléctrico! No contiene dentro componentes servibles para el usuario. Desconecte el cable de alimentación antes de quitar la cubierta.

INDOOR USE ONLY!

Únicamente para uso en el interior.

POWER SUPPLY BLADE/CORD: AC Mains voltage should be provided to the power supply by a power supply cords approved to the national standards in which it will be used. Please use the below table as a guideline for Suitable Power cords.

PROPRIETARY INFORMATION

<p>GlobTek, Inc. www.globtek.com 186 Veterans Drive, Northvale, NJ 07647 Tel. (201) 784-1000 Fax (201) 784-0111</p>	<p>Drawing Title: GTM46161-155.0-USB2C, ICT / ITE / Medical Power Supply, Efficiency Level: USA DOE Level VI / Eco-design Directive 2009/125/EC, (EU) 2019/1782, Case Color/Style: GlobTek White, Wall Plug-in, Regulated Switchmode AC-DC Power Supply AC Adaptor, Input Rating: 100-240V~, 50-60 Hz, Interchangeable Blades http://en.globtek.com/interchangeable-blades.php, Output Rating: 15W, 5.0V@3.0A, Output Configuration: N/A mm, N/A/4 Cond, N/A, Dual Type "C" USB "JACKS", integral to power supply enclosure compliant with Directive (EU) 2022/2380 and 2014/53/EU Radio Equipment Directive (RED), Ferrite: None, N/A, GT Cord # C69399, Pin Out: A1, A12, B1, B12: GND A4, A9, B4, B9: V+ CC1: A5 CC2: B5 D+: A6, B6 D-: A7, B7, Blades/Input Cord: White color, Approvals:</p>
	<p>Model No. GTM46161-155.0-USB2C</p>
	<p>Part No./Ordering No. WR9QA3000USBC2CNAIMR6W Rev B</p>

CABLE DE ALIMENTACIÓN: El voltaje de la CA debe proporcionarse a la fuente de alimentación mediante los cables de alimentación aprobados conforme a las normas nacionales según las cuales será utilizada. Utilice por favor la tabla mencionada aquí abajo como guía para los cables eléctricos adecuados.

1. Class II model NEMA 1-15P AC power plug with 2 prongs, Q-NA(R)
2. Australian AS 3112 configuration: SAA 2 pins Class II, Q-SAA(R)
3. UK BS 1363 configuration: UK 2 pins Class II, Q-UK(R)
4. European CEE 7/16 configuration: Europlug 2 PINS, Class II, Q-EU(R)
5. Korean KS C8305 configuration: Q-KR(R)
6. Argentina IRAM 2073 configuration: 2 pins, Class II Q-AR(R)
7. China GR 2099 configuration: 2 pins, Class II Q-CN(R)
8. India configuration: 2 pins, Class II, Q-IN(R)
9. IEC320/C18 Inlet

FUSING: Internal fuse for Line is provided in the power supply. A blown internal fuse is an indication of catastrophic failure of circuit component(s). Repair must be performed by GlobTek, Inc. authorized personnel. Fuses must be replaced with same type and ratings per GlobTek internal documentation.

FUSIBLES: La fuente de alimentación provee un fusible interno para la línea. Un fusible interno quemado es un indicador de una falla catastrófica de los componentes del circuito. La reparación debe ser hecha por personal autorizado de GlobTek, Inc. Los fusibles se deben reemplazar por los mismos tipos y rangos que la documentación interna de GlobTek mencione.

GlobTek, Inc.
www.globtek.com
186 Veterans Drive,
Northvale, NJ 07647
Tel. (201) 784-1000
Fax (201) 784-0111

Drawing Title: GTM46161-155.0-USB2C, ICT / ITE / Medical Power Supply, Efficiency Level: USA DOE Level VI / Eco-design Directive 2009/125/EC, (EU) 2019/1782, Case Color/Style: GlobTek White, Wall Plug-in, Regulated Switchmode AC-DC Power Supply AC Adaptor, Input Rating: 100-240V~, 50-60 Hz, Interchangeable Blades <http://en.globtek.com/interchangeable-blades.php>, Output Rating: 15W, 5.0V@3.0A, Output Configuration: N/A mm, N/A/4 Cond, N/A, Dual Type "C" USB "JACKS", integral to power supply enclosure compliant with Directive (EU) 2022/2380 and 2014/53/EU Radio Equipment Directive (RED), Ferrite: None, N/A, GT Cord # C69399, Pin Out: A1, A12, B1, B12: GND A4, A9, B4, B9: V+ CC1: A5 CC2: B5 D+: A6, B6 D-: A7, B7, Blades/Input Cord: White color, Approvals:

Model No. GTM46161-155.0-USB2C

Part No./Ordering No. WR9QA3000USBC2CNAIMR6W

Rev B

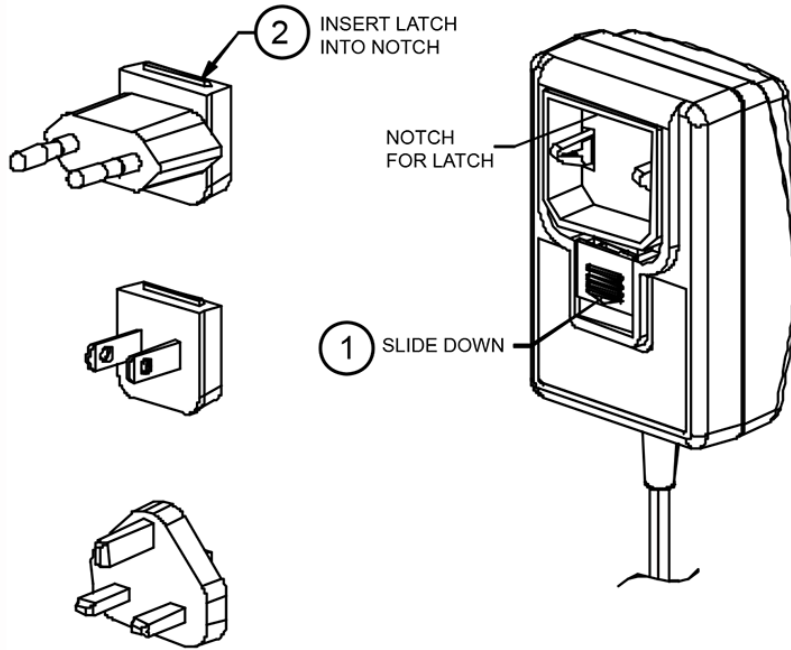

This symbol on an instrument indicates that the user should refer to the operating instructions located in the manual.

Please note:

The blades shown above are for representation of the installation process and do not indicate which AC blades are included with this power supply. Please reference the specifications "Power Supply Information" (page 2) and "Input Configuration" (page 6) for information regarding the actual blade included with this power supply, if any.

<p>GlobTek, Inc. www.globtek.com 186 Veterans Drive, Northvale, NJ 07647 Tel. (201) 784-1000 Fax (201) 784-0111</p>	<p>Drawing Title: GTM46161-155.0-USB2C, ICT / ITE / Medical Power Supply, Efficiency Level: USA DOE Level VI / Eco-design Directive 2009/125/EC, (EU) 2019/1782, Case Color/Style: GlobTek White, Wall Plug-in, Regulated Switchmode AC-DC Power Supply AC Adaptor, Input Rating: 100-240V~, 50-60 Hz, Interchangeable Blades http://en.globtek.com/interchangeable-blades.php, Output Rating: 15W, 5.0V@3.0A, Output Configuration: N/A mm, N/A/4 Cond, N/A, Dual Type "C" USB "JACKS", integral to power supply enclosure compliant with Directive (EU) 2022/2380 and 2014/53/EU Radio Equipment Directive (RED), Ferrite: None, N/A, GT Cord # C69399, Pin Out: A1, A12, B1, B12: GND A4, A9, B4, B9: V+ CC1: A5 CC2: B5 D+: A6, B6 D-: A7, B7, Blades/Input Cord: White color, Approvals:</p>
	<p>Model No. GTM46161-155.0-USB2C</p>
	<p>Part No./Ordering No. WR9QA3000USBC2CNAIMR6W</p>
	<p>Rev B</p>

