

IGBT (NPT) Module

$$V_{CES} = 1200V$$

$$I_{C25} = 160A$$

$$V_{CE(sat)} = 2.2V$$

Buck Chopper + free wheeling Diode

Part number

MDI145-12A3



Backside: isolated

 E72873

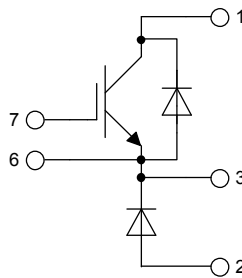

Features / Advantages:

- NPT IGBT technology
- low saturation voltage
- low switching losses
- switching frequency up to 30 kHz
- square RBSOA, no latch up
- high short circuit capability
- positive temperature coefficient for easy parallelling
- MOS input, voltage controlled
- ultra fast free wheeling diodes

Applications:

- AC motor drives
- Solar inverter
- Medical equipment
- Uninterruptible power supply
- Air-conditioning systems
- Welding equipment
- Switched-mode and resonant-mode power supplies
- Inductive heating, cookers
- Pumps, Fans

Package: Y4

- Isolation Voltage: 3600 V~
- Industry standard outline
- RoHS compliant
- Soldering pins for PCB mounting
- Base plate: DCB ceramic
- Reduced weight
- Advanced power cycling

Free Wheeling Diode FWD				Ratings			
Symbol	Definition	Conditions	min.	typ.	max.	Unit	
V_{RSM}	max. non-repetitive reverse blocking voltage				1200	V	
V_{RRM}	max. repetitive reverse blocking voltage				1200	V	
I_R	reverse current, drain current	$V_R = 1200\text{ V}$			1	mA	
		$V_R = 1200\text{ V}$			3	mA	
V_F	forward voltage drop	$I_F = 100\text{ A}$			2.60	V	
		$I_F = 200\text{ A}$			3.10	V	
		$I_F = 100\text{ A}$	$T_{VJ} = 125^\circ\text{C}$			2.00	V
		$I_F = 200\text{ A}$	$T_{VJ} = 125^\circ\text{C}$			2.40	V
I_{FAV}	average forward current	$T_C = 80^\circ\text{C}$			95	A	
		DC current	$d = 1$	$T_{VJ} = 150^\circ\text{C}$			
V_{FO}	threshold voltage	} for power loss calculation only			1.30	V	
r_F	slope resistance				7.5	mΩ	
R_{thJC}	thermal resistance junction to case				0.18	K/W	
R_{thCH}	thermal resistance case to heatsink			0.18		K/W	
P_{tot}	total power dissipation		$T_C = 25^\circ\text{C}$		700	W	
I_{FSM}	max. forward surge current	$t = 10\text{ ms}; (50\text{ Hz}), \text{ sine}; V_R = 0\text{ V}$		$T_{VJ} = 45^\circ\text{C}$	700	A	
C_J	junction capacitance	$V_R = 600\text{ V}$ $f = 1\text{ MHz}$		$T_{VJ} = 25^\circ\text{C}$	30	pF	

Buck IGBT				Ratings			
Symbol	Definition	Conditions	min.	typ.	max.	Unit	
V_{CES}	collector emitter voltage				1200	V	
V_{GES}	max. DC gate voltage				±20	V	
V_{GEM}	max. transient gate emitter voltage				±30	V	
I_{C25}	collector current				160	A	
I_{C80}					110	A	
P_{tot}	total power dissipation				700	W	
$V_{CE(sat)}$	collector emitter saturation voltage	$I_C = 100A; V_{GE} = 15V$			2.2	V	
					2.7	V	
$V_{GE(th)}$	gate emitter threshold voltage	$I_C = 4mA; V_{GE} = V_{CE}$	4.5	5.5	6.5	V	
I_{CES}	collector emitter leakage current	$V_{CE} = V_{CES}; V_{GE} = 0V$			6	mA	
					9	mA	
I_{GES}	gate emitter leakage current	$V_{GE} = \pm 20V$			400	nA	
$Q_{G(on)}$	total gate charge	$V_{CE} = 600V; V_{GE} = 15V; I_C = 100A$		480		nC	
$t_{d(on)}$	turn-on delay time	inductive load $V_{CE} = 600V; I_C = 100A$ $V_{GE} = \pm 15V; R_G = 6.8\Omega$		100		ns	
t_r	current rise time			60		ns	
$t_{d(off)}$	turn-off delay time			600		ns	
t_f	current fall time			90		ns	
E_{on}	turn-on energy per pulse			16		mJ	
E_{off}	turn-off energy per pulse			15		mJ	
RBSOA	reverse bias safe operating area	$V_{GE} = \pm 15V; R_G = 6.8\Omega$					
I_{CM}		$V_{CEmax} = 1200V$			200	A	
SCSOA	short circuit safe operating area	$V_{CEmax} = 1200V$					
t_{SC}	short circuit duration	$V_{CE} = 1200V; V_{GE} = \pm 15V$			10	µs	
I_{SC}	short circuit current	$R_G = 6.8\Omega; \text{non-repetitive}$		330		A	
R_{thJC}	thermal resistance junction to case				0.18	K/W	
R_{thCH}	thermal resistance case to heatsink			0.18		K/W	
Buck Diode BD							
V_{RRM}	max. repetitive reverse voltage				1200	V	
I_{F25}	forward current				150	A	
I_{F80}					95	A	
V_F	forward voltage	$I_F = 100A$			2.60	V	
					1.90	V	
I_R	reverse current	$V_R = V_{RRM}$			1	mA	
					1.5	mA	
Q_{rr}	reverse recovery charge	$V_R = 600V$ $-di_F/dt = 600A/\mu s$ $I_F = 100A; V_{GE} = 0V$		8.5		µC	
I_{RM}	max. reverse recovery current			62		A	
t_{rr}	reverse recovery time			200		ns	
E_{rec}	reverse recovery energy			1.5		mJ	
R_{thJC}	thermal resistance junction to case				0.45	K/W	
R_{thCH}	thermal resistance case to heatsink			0.45		K/W	

Package Y4				Ratings		
Symbol	Definition	Conditions	min.	typ.	max.	Unit
I_{RMS}	RMS current	per terminal			300	A
T_{VJ}	virtual junction temperature		-40		150	°C
T_{op}	operation temperature		-40		125	°C
T_{stg}	storage temperature		-40		125	°C
Weight					108	g
M_D	mounting torque		2.25		2.75	Nm
M_T	terminal torque		4.5		5.5	Nm
$d_{Spp/App}$	creepage distance on surface striking distance through air	terminal to terminal	14.0	10.0		mm
$d_{Spb/Apb}$		terminal to backside	16.0	16.0		mm
V_{ISOL}	isolation voltage	t = 1 second			3600	V
		t = 1 minute	50/60 Hz, RMS; $I_{ISOL} \leq 1$ mA		3000	V

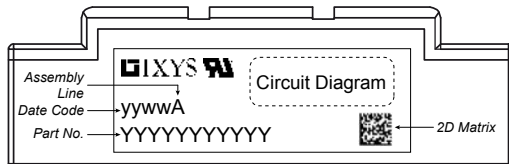

Ordering	Part Number	Marking on Product	Delivery Mode	Quantity	Code No.
Standard	MDI145-12A3	MDI145-12A3	Box	6	474223

Outlines Y4

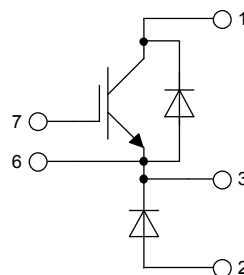
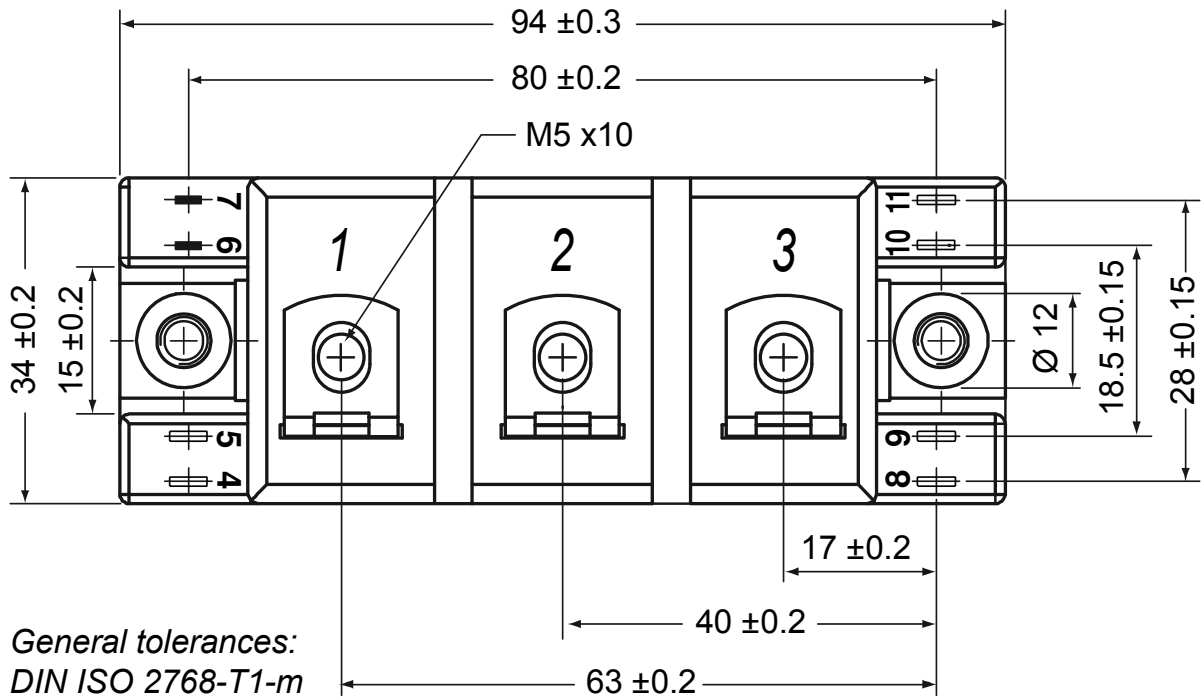
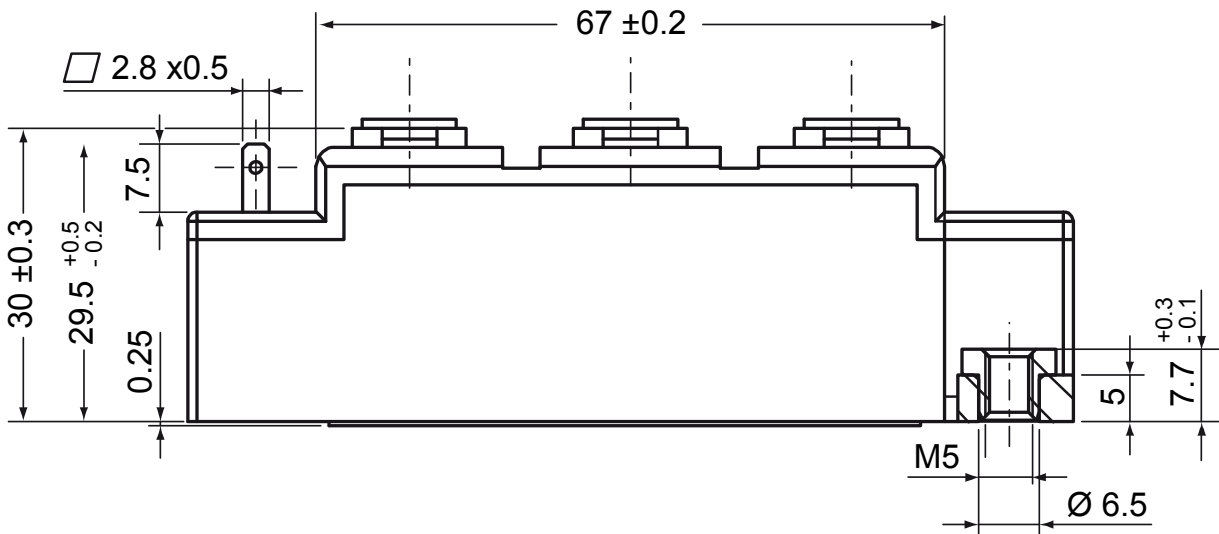

Buck IGBT

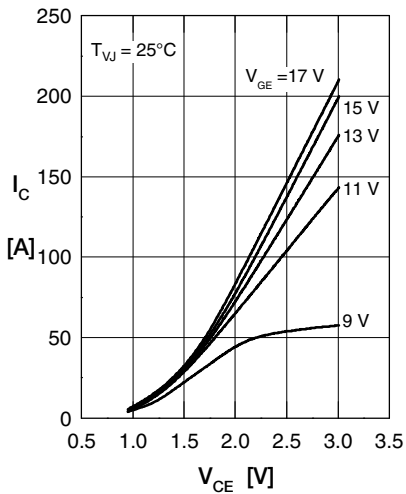

Fig. 1 Typ. output characteristics

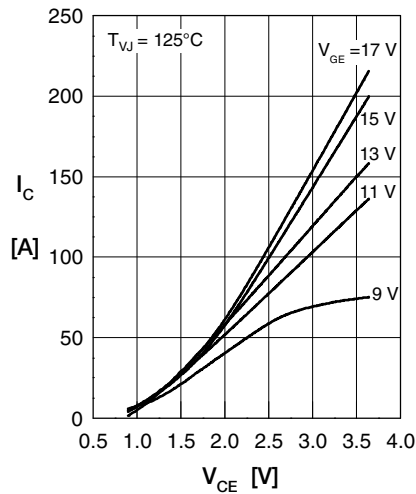

Fig. 2 Typ. output characteristics

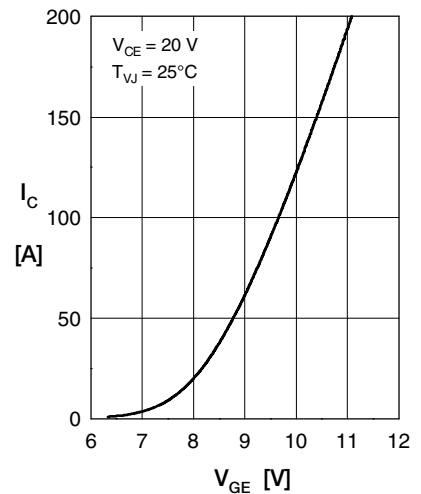

Fig. 3 Typ. transfer characteristics

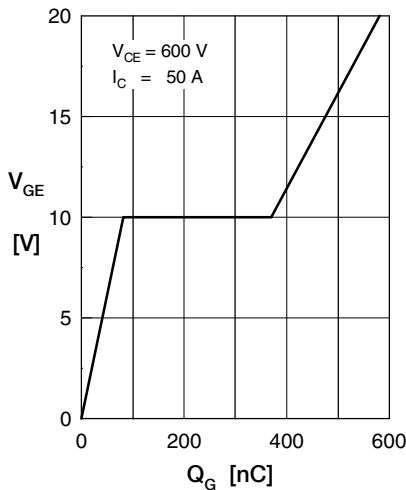

Fig. 4 Typ. turn-on gate charge

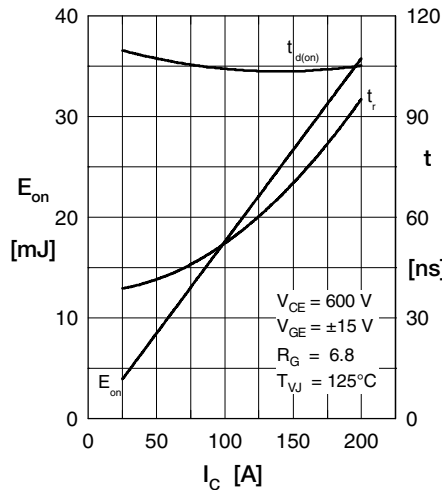

Fig. 5 Typ. turn on energy & switching times versus collector current

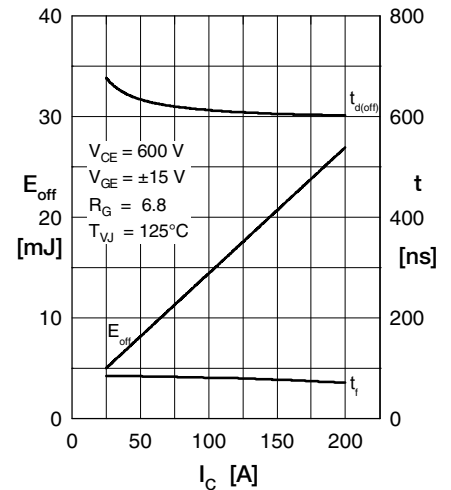

Fig. 6 Typ. turn off energy & switching times versus collector current

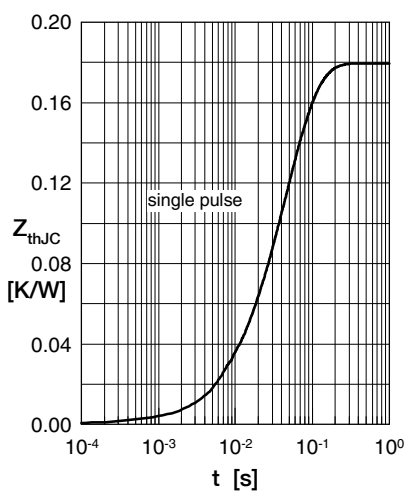

Fig. 12 Typical transient thermal impedance

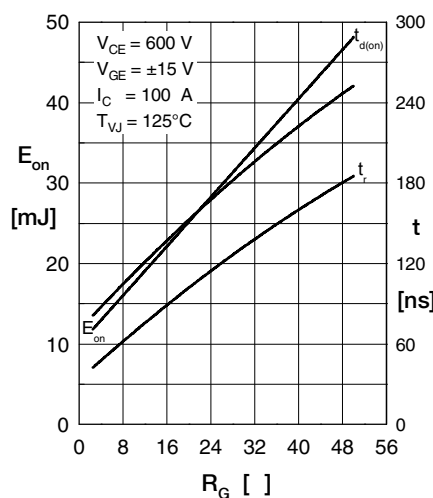

Fig. 9 Typ. turn on energy & switching times versus gate resistor

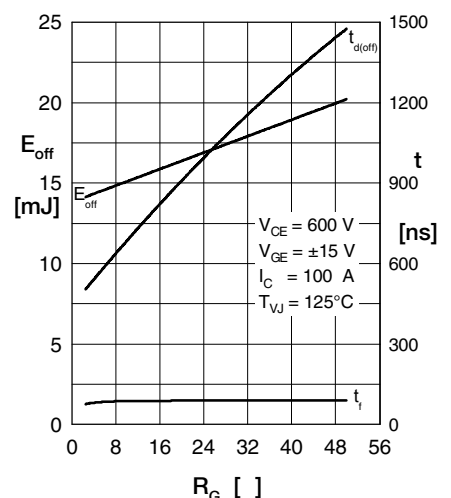

Fig. 9 Typ. turn off energy & switching times versus gate resistor

Buck Diode BD

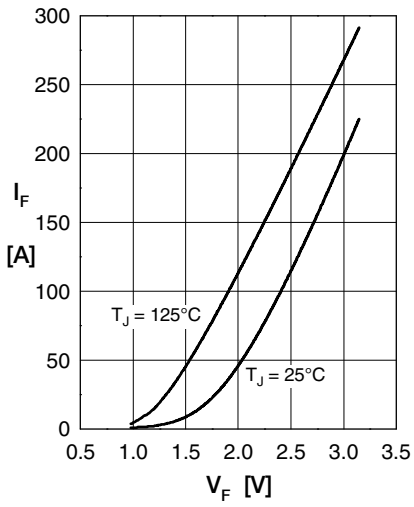

Fig. 1 Typ. Forward current vs. V_F

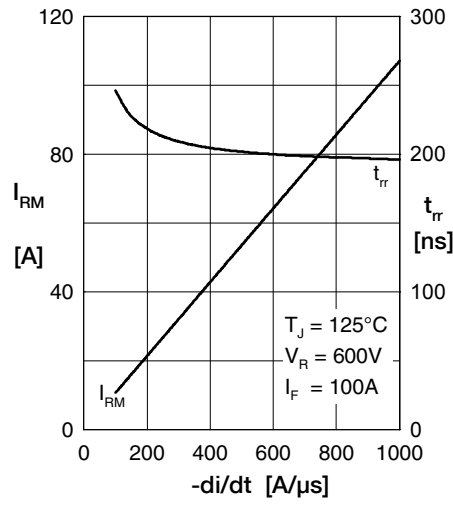

Fig. 2 Typ. peak reverse current I_{RM} versus di/dt

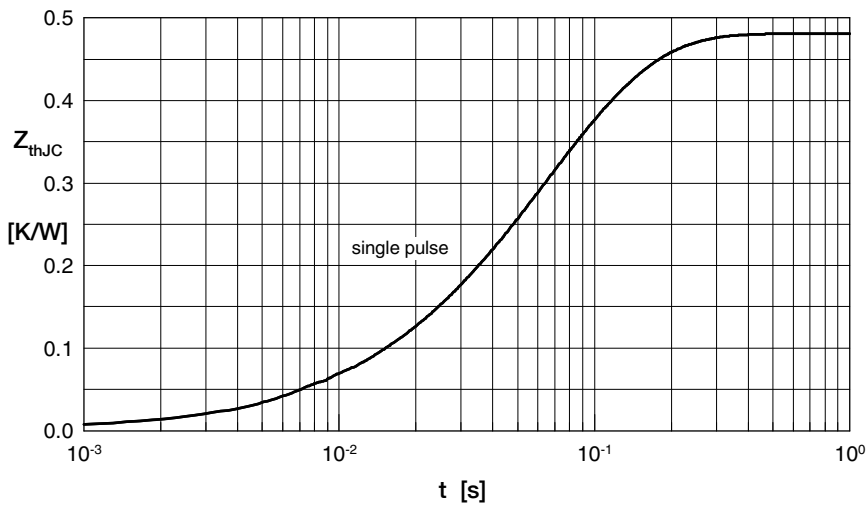

Fig. 3 Typ. transient thermal impedance junction to case