

Dimensions: [mm]

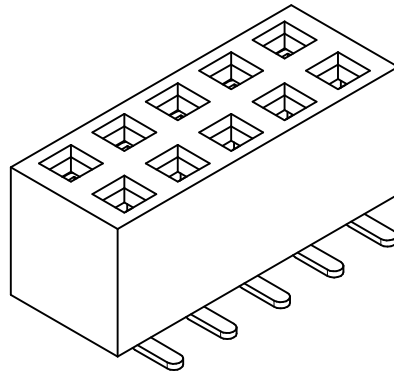

Recommended Land Pattern: [mm]

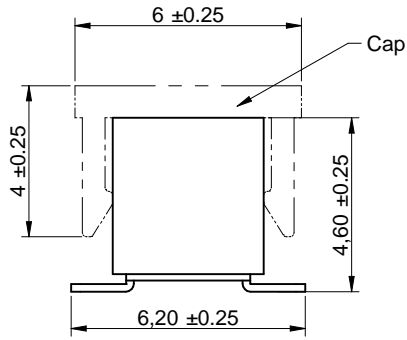
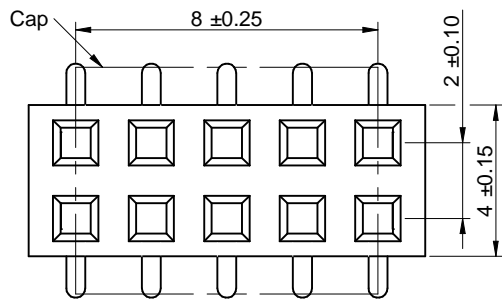
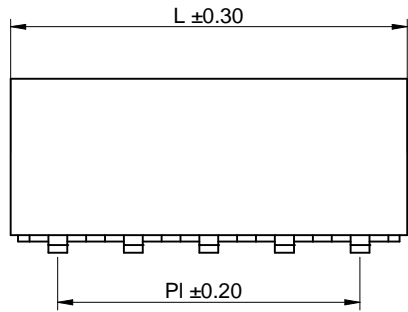
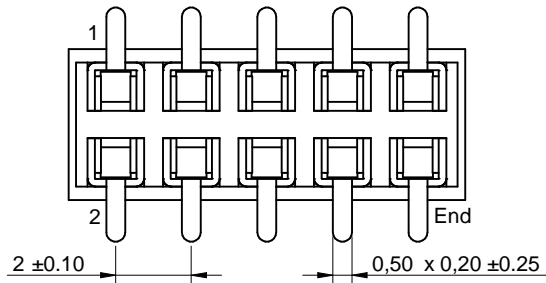
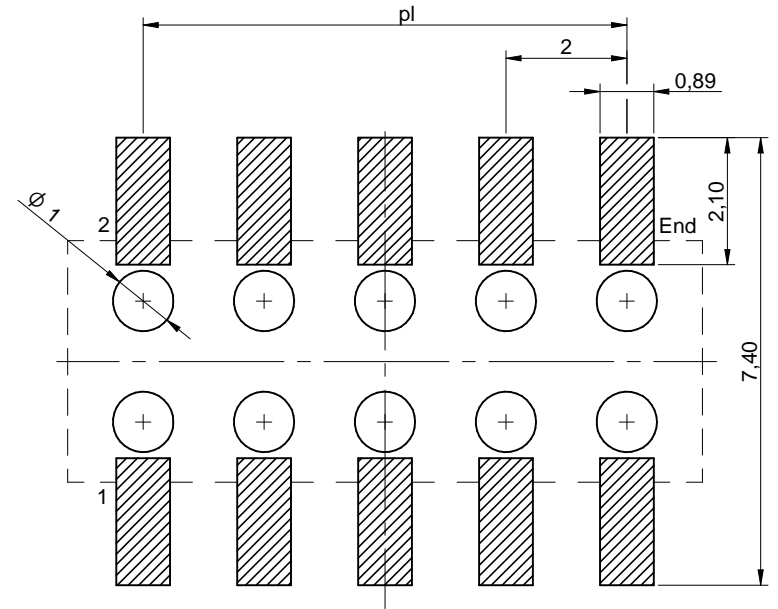

General tolerance ± 0.05

Pattern Properties:

Properties		Value	Unit
Pin to Pin (Middle)	p_1	8	mm

Article Properties:

Properties		Value	Unit
Pins		10	
Pin to Pin (Middle)	p_1	8	mm
Length	L	10.6	mm

Würth Elektronik eiSos GmbH & Co. KG
EMC & Inductive Solutions

Max-Eyth-Str. 1
74638 Waldenburg
Germany
Tel. +49 (0) 79 42 945 - 0

www.we-online.com
eiSos@we-online.com



CREATED DaMa	CHECKED GM	GENERAL TOLERANCE DIN ISO 2768-1m	PROJECTION METHOD
DESCRIPTION 2.00mm SMT Straight Dual Bottom Entry Socket Header WR-PHD		ORDER CODE 621310242921	
REVISION 002.000	STATUS Valid	DATE (YYYY-MM-DD) 2017-07-03	BUSINESS UNIT eiCan
		PAGE 1/6	

Article Properties:

Pins	P ₁	L	Order Code
4	2 mm	4.6 mm	621304242921
6	4 mm	6.6 mm	621306242921
8	6 mm	8.6 mm	621308242921
10	8 mm	10.6 mm	621310242921
12	10 mm	12.6 mm	621312242921
14	12 mm	14.6 mm	621314242921
16	14 mm	16.6 mm	621316242921
18	16 mm	18.6 mm	621318242921
20	18 mm	20.6 mm	621320242921
22	20 mm	22.6 mm	621322242921
24	22 mm	24.6 mm	621324242921
26	24 mm	26.6 mm	621326242921
28	26 mm	28.6 mm	621328242921
30	28 mm	30.6 mm	621330242921
32	30 mm	32.6 mm	621332242921
34	32 mm	34.6 mm	621334242921
36	34 mm	36.6 mm	621336242921
38	36 mm	38.6 mm	621338242921
40	38 mm	40.6 mm	621340242921
42	40 mm	42.6 mm	621342242921
44	42 mm	44.6 mm	621344242921
46	44 mm	46.6 mm	621346242921
48	46 mm	48.6 mm	621348242921
50	48 mm	50.6 mm	621350242921
52	50 mm	52.6 mm	621352242921
54	52 mm	54.6 mm	621354242921
56	54 mm	56.6 mm	621356242921
58	56 mm	58.6 mm	621358242921

60	58 mm	60.6 mm	621360242921
62	60 mm	62.6 mm	621362242921
64	62 mm	64.6 mm	621364242921
66	64 mm	66.6 mm	621366242921
68	66 mm	68.6 mm	621368242921
70	68 mm	70.6 mm	621370242921
72	70 mm	72.6 mm	621372242921
74	72 mm	74.6 mm	621374242921
76	74 mm	76.6 mm	621376242921
78	76 mm	78.6 mm	621378242921
80	78 mm	80.6 mm	621380242921

Kind Properties:

Properties	Value	Unit
Standard Polarities ¹⁾	04;06;08;10;14;16;20;24;44	
Pitch	P 2	mm
Quality Class	3 as per CECC 75 301-802	
Rows	Dual	
Gender	Female	
Type	Bottom Entry	
Coplanarity	100	µm

¹⁾ Delivery ex stock for standard polarities, non standard have extended leadtimes and MOQ

Material Properties:

Insulator Material	PA9T
Insulator Flammability Rating	UL94 V-0
Insulator Color	Black
Contact Material	Copper Alloy
Contact Plating	Gold
Contact Type	Stamped

Würth Elektronik eiSos GmbH & Co. KG
EMC & Inductive Solutions

Max-Eyth-Str. 1
74638 Waldenburg
Germany
Tel. +49 (0) 79 42 945 - 0

www.we-online.com
eiSos@we-online.com



CREATED DaMa	CHECKED GM	GENERAL TOLERANCE DIN ISO 2768-1m	PROJECTION METHOD
DESCRIPTION 2.00mm SMT Straight Dual Bottom Entry Socket Header WR-PHD		ORDER CODE 621310242921	
REVISION 002.000	STATUS Valid	DATE (YYYY-MM-DD) 2017-07-03	BUSINESS UNIT eiCan
		PAGE 2/6	

General Properties:

Operating Temperature	-40 °C up to +105 °C
Compliance	Lead free / RoHS

Electrical Properties:

Properties	Test conditions		Value	Unit	Tol.
Rated Current		I _R	2	A	max.
Working Voltage			200	V (AC)	
Withstanding Voltage	1 min		500	V (AC)	
Contact Resistance		R	20	mΩ	max.
Insulation Resistance		R _{ISO}	1000	MΩ	min.

Standard:

UL Approval	E323964
-------------	---------

Packaging Properties:

Packaging	Tape and Reel with Cap
Packaging Unit (Qty.)	800

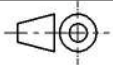
Würth Elektronik eiSos GmbH & Co. KG EMC & Inductive Solutions Max-Eyth-Str. 1 74638 Waldenburg Germany Tel. +49 (0) 79 42 945 - 0 www.we-online.com eiSos@we-online.com	CREATED DaMa	CHECKED GM	GENERAL TOLERANCE DIN ISO 2768-1m	PROJECTION METHOD 	
	DESCRIPTION 2.00mm SMT Straight Dual Bottom Entry Socket Header WR-PHD			ORDER CODE 621310242921	
	REVISION 002.000	STATUS Valid	DATE (YYYY-MM-DD) 2017-07-03	BUSINESS UNIT eiCan	PAGE 3/6



Classification Reflow Profile for SMT components:



Classification Reflow Soldering Profile:

Profile Feature		Value
Preheat Temperature Min ¹⁾	$T_{s \text{ min}}$	150 °C
Preheat Temperature Max	$T_{s \text{ max}}$	200 °C
Preheat Time t_s from $T_{s \text{ min}}$ to $T_{s \text{ max}}$	t_s	60 - 120 seconds
Ramp-up Rate (T_L to T_p)		3 °C/ second max.
Liquidous Temperature	T_L	217 °C
Time t_L maintained above T_L	t_L	60 - 150 seconds
Peak package body temperature	T_p	see table
Time within 5°C of actual peak temperature	t_p	20 - 30 seconds
Ramp-down Rate (T_L to T_p)		6 °C/ second max.
Time 25°C to peak temperature		8 minutes max.

¹⁾ refer to IPC/JEDEC J-STD-020D
refer to IPC/ JEDEC J-STD-020E

Package Classification Reflow Temperature:

Properties	Volume mm ³ <350	Volume mm ³ 350-2000	Volume mm ³ >2000
PB-Free Assembly Package Thickness < 1.6 mm ¹⁾	260 °C	260 °C	260 °C
PB-Free Assembly Package Thickness 1.6 mm - 2.5 mm	260 °C	250 °C	245 °C
PB-Free Assembly Package Thickness ≥ 2.5 mm	250 °C	245 °C	245 °C

¹⁾ refer to IPC/JEDEC J-STD-020D
refer to IPC/ JEDEC J-STD-020E

Würth Elektronik eiSos GmbH & Co. KG
EMC & Inductive Solutions

Max-Eyth-Str. 1
74638 Waldenburg
Germany
Tel. +49 (0) 79 42 945 - 0

www.we-online.com
eiSos@we-online.com



CREATED DaMa	CHECKED GM	GENERAL TOLERANCE DIN ISO 2768-1m	PROJECTION METHOD
DESCRIPTION 2.00mm SMT Straight Dual Bottom Entry Socket Header WR-PHD		ORDER CODE 621310242921	
REVISION 002.000	STATUS Valid	DATE (YYYY-MM-DD) 2017-07-03	BUSINESS UNIT eiCan
		PAGE 4/6	

Cautions and Warnings:

The following conditions apply to all goods within the product services of the Connectors of Würth Elektronik eiSos GmbH & Co. KG:

General:

- This electronic component is designed and developed with the intention for use in general electronics equipment.
- Before incorporating the components into any equipment in the field such as aerospace, aviation, nuclear control, submarine, transportation, (automotive control, train control, ship control), transportation signal, disaster prevention, medical, public information network etc. where higher safety and reliability are especially required or if there is possibility of direct damage or injury to human body, Würth Elektronik must be asked for a written approval.
- In addition, even electronic component in general electronic equipment, when used in electrical circuits that require high safety, reliability functions or performance, the sufficient reliability evaluation-check for the safety must be performed by the user before usage.
- The connector is designed and manufactured to be used within the datasheet specified values.
- Do not use the connector outside the datasheet specifications.
- Prevent any damage or scratches on the connector, especially on the actuator.
- Direct mechanical impact to the product shall be prevented (e.g overlapping of the PCB's).
- The responsibility for the applicability of the customer specific products and use in a particular customer design is always within the authority of the customer. All technical specification for standard products do also apply to customer specific products.
- The Connectors are designed to be used along with Würth Elektronik counterparts and tools. Würth Elektronik cannot insure the reliability of these components while being used with other products.

Product Specific:

Soldering:

- The solder profile must comply with the WE technical soldering specification, otherwise this will void the warranty.
- Other soldering methods are not verified and have to be validated by the customer at his own risk.

Cleaning and Washing:

- Parts are not constructed for washing, so washing can cause malfunction afterwards.
- Cleaning agent that are used to clean the customer applications might damage or change the characteristics of the component, body, pins and termination.
- Please do not submerge our washable products into water or cleaning agents or put them in locations exposed to water completely.
- When cleaning by hand (brushing), please do not use excessive force on our connectors to avoid malfunction afterwards, because customer could deform function relevant areas.
- We recommended a solution without organic acid (preserve the plating against corrosion) volatile, without residues and compatible with the plastic.

- We recommend to perform tests and to let a part in immersion in the solution 8 to 12 hours and see if there is a degradation.

Storage Conditions:

- The Connectors are considered MSL1 into closed original packaging and are not subject to storage time limits regarding the moisture sensitivity but all products shall be used before the end of the period of 12 months based on the products date code, if not 100% solderability can't be warranted.

Handling:

- Do not repeatedly operate the connector with excessive force. It may damage or deforms the contact dome which results in malfunction.
- In the case a product requires particular handling precautions, in addition to the general recommendations mentioned here before, these will appear on the product datasheet.

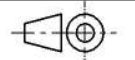
Würth Elektronik eiSos GmbH & Co. KG EMC & Inductive Solutions Max-Eyth-Str. 1 74638 Waldenburg Germany Tel. +49 (0) 79 42 945 - 0 www.we-online.com eiSos@we-online.com 	CREATED DaMa	CHECKED GM	GENERAL TOLERANCE DIN ISO 2768-1m	PROJECTION METHOD 
	DESCRIPTION 2.00mm SMT Straight Dual Bottom Entry Socket Header WR-PHD			ORDER CODE 621310242921
	REVISION 002.000	STATUS Valid	DATE (YYYY-MM-DD) 2017-07-03	BUSINESS UNIT eiCan

Important Notes

The following conditions apply to all goods within the product range of Würth Elektronik eiSos GmbH & Co. KG:

1. General Customer Responsibility

Some goods within the product range of Würth Elektronik eiSos GmbH & Co. KG contain statements regarding general suitability for certain application areas. These statements about suitability are based on our knowledge and experience of typical requirements concerning the areas, serve as general guidance and cannot be estimated as binding statements about the suitability for a customer application. The responsibility for the applicability and use in a particular customer design is always solely within the authority of the customer. Due to this fact it is up to the customer to evaluate, where appropriate to investigate and decide whether the device with the specific product characteristics described in the product specification is valid and suitable for the respective customer application or not.

2. Customer Responsibility related to Specific, in particular Safety-Relevant Applications

It has to be clearly pointed out that the possibility of a malfunction of electronic components or failure before the end of the usual lifetime cannot be completely eliminated in the current state of the art, even if the products are operated within the range of the specifications. In certain customer applications requiring a very high level of safety and especially in customer applications in which the malfunction or failure of an electronic component could endanger human life or health it must be ensured by most advanced technological aid of suitable design of the customer application that no injury or damage is caused to third parties in the event of malfunction or failure of an electronic component. Therefore, customer is cautioned to verify that data sheets are current before placing orders. The current data sheets can be downloaded at www.we-online.com.

3. Best Care and Attention

Any product-specific notes, cautions and warnings must be strictly observed. Any disregard will result in the loss of warranty.

4. Customer Support for Product Specifications

Some products within the product range may contain substances which are subject to restrictions in certain jurisdictions in order to serve specific technical requirements. Necessary information is available on request. In this case the field sales engineer or the internal sales person in charge should be contacted who will be happy to support in this matter.

5. Product R&D

Due to constant product improvement product specifications may change from time to time. As a standard reporting procedure of the Product Change Notification (PCN) according to the JEDEC-Standard inform about minor and major changes. In case of further queries regarding the PCN, the field sales engineer or the internal sales person in charge should be contacted. The basic responsibility of the customer as per Section 1 and 2 remains unaffected.

6. Product Life Cycle



Due to technical progress and economical evaluation we also reserve the right to discontinue production and delivery of products. As a standard reporting procedure of the Product Termination Notification (PTN) according to the JEDEC-Standard we will inform at an early stage about inevitable product discontinuance. According to this we cannot guarantee that all products within our product range will always be available. Therefore it needs to be verified with the field sales engineer or the internal sales person in charge about the current product availability expectancy before or when the product for application design-in disposal is considered. The approach named above does not apply in the case of individual agreements deviating from the foregoing for customer-specific products.

7. Property Rights

All the rights for contractual products produced by Würth Elektronik eiSos GmbH & Co. KG on the basis of ideas, development contracts as well as models or templates that are subject to copyright, patent or commercial protection supplied to the customer will remain with Würth Elektronik eiSos GmbH & Co. KG. Würth Elektronik eiSos GmbH & Co. KG does not warrant or represent that any license, either expressed or implied, is granted under any patent right, copyright, mask work right, or other intellectual property right relating to any combination, application, or process in which Würth Elektronik eiSos GmbH & Co. KG components or services are used.

8. General Terms and Conditions

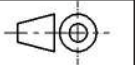
Unless otherwise agreed in individual contracts, all orders are subject to the current version of the "General Terms and Conditions of Würth Elektronik eiSos Group", last version available at www.we-online.com.

Würth Elektronik eiSos GmbH & Co. KG EMC & Inductive Solutions Max-Eyth-Str. 1 74638 Waldenburg Germany Tel. +49 (0) 79 42 945 - 0 www.we-online.com eiSos@we-online.com	CREATED DaMa	CHECKED GM	GENERAL TOLERANCE DIN ISO 2768-1m	PROJECTION METHOD 
	DESCRIPTION 2.00mm SMT Straight Dual Bottom Entry Socket Header WR-PHD		ORDER CODE 621310242921	
		REVISION 002.000	STATUS Valid	DATE (YYYY-MM-DD) 2017-07-03
			PAGE 6/6	