

National Semiconductor is now part of
Texas Instruments.

Search <http://www.ti.com/> for the latest technical
information and details on our current products and services.

LM611 Operational Amplifier and Adjustable Reference

General Description

The LM611 consists of a single-supply op-amp and a programmable voltage reference in one space saving 8-pin package. The op-amp out-performs most single-supply op-amps by providing higher speed and bandwidth along with low supply current. This device was specifically designed to lower cost and board space requirements in transducer, test, measurement and data acquisition systems.

Combining a stable voltage reference with a wide output swing op-amp makes the LM611 ideal for single supply transducers, signal conditioning and bridge driving where large common-mode signals are common. The voltage reference consists of a reliable band-gap design that maintains low dynamic output impedance (1Ω typical), excellent initial tolerance (0.6%), and the ability to be programmed from 1.2V to 6.3V via two external resistors. The voltage reference is very stable even when driving large capacitive loads, as are commonly encountered in CMOS data acquisition systems.

As a member of National's Super-Block™ family, the LM611 is a space-saving monolithic alternative to a multi-chip solution, offering a high level of integration without sacrificing performance.

Features

OP AMP

- Low operating current: 300 μ A (op amp)
- Wide supply voltage range: 4V to 36V
- Wide common-mode range: V^- to ($V^+ - 1.8V$)
- Wide differential input voltage: $\pm 36V$
- Available in low cost 8-pin DIP
- Available in plastic package rated for Military Temperature Range Operation

REFERENCE

- Adjustable output voltage: 1.2V to 6.3V
- Tight initial tolerance available: $\pm 0.6\%$
- Wide operating current range: 17 μ A to 20 mA
- Reference floats above ground
- Tolerant of load capacitance

Applications

- Transducer bridge driver
- Process and Mass Flow Control systems
- Power supply voltage monitor
- Buffered voltage references for A/D's

Connection Diagrams

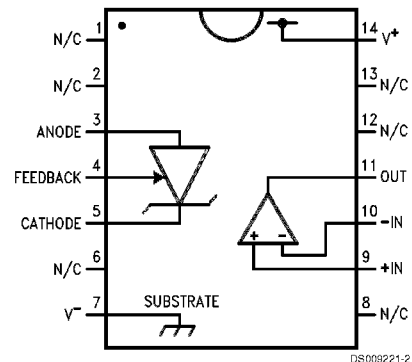
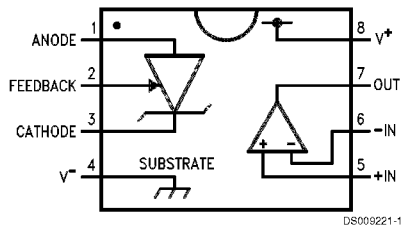

Super-Block™ is a trademark of National Semiconductor Corporation.

Absolute Maximum Ratings (Note 1)

If Military/Aerospace specified devices are required, please contact the National Semiconductor Sales Office/Distributors for availability and specifications.

Voltage on Any Pins Except V_R (referred to V^- pin) (Note 2)	36V (Max) -0.3V (Min)
Current through Any Input Pin and V_R Pin	± 20 mA
Differential Input Voltage Military and Industrial Commercial	± 36 V ± 32 V
Storage Temperature Range	$-65^\circ\text{C} \leq T_J \leq +150^\circ\text{C}$
Maximum Junction Temperature	150°C

Thermal Resistance, Junction-to-Ambient (Note 3)

N Package	100°C/W
M Package	150°C/W
Soldering Information Soldering (10 seconds)	
N Package	260°C
M Package	220°C
ESD Tolerance (Note 4)	± 1 kV

Operating Temperature Range

LM611AI, LM611I, LM611BI	$-40^\circ\text{C} \leq T_J \leq +85^\circ\text{C}$
LM611AM, LM611M	$-55^\circ\text{C} \leq T_J \leq +125^\circ\text{C}$
LM611C	$0^\circ\text{C} \leq T_J \leq 70^\circ\text{C}$

Electrical Characteristics

These specifications apply for $V^- = \text{GND} = 0\text{V}$, $V^+ = 5\text{V}$, $V_{\text{CM}} = V_{\text{OUT}} = 2.5\text{V}$, $I_R = 100\ \mu\text{A}$, FEEDBACK pin shorted to GND, unless otherwise specified. Limits in standard typeface are for $T_J = 25^\circ\text{C}$; limits in **boldface type** apply over the **Operating Temperature Range**.

Symbol	Parameter	Conditions	Typical (Note 5)	LM611AM	LM611M	Units
				LM611AI Limits (Note 6)	LM611BI LM611I LM611C Limits (Note 6)	
I_S	Total Supply Current	$R_{\text{LOAD}} = \infty$, $4\text{V} \leq V^+ \leq 36\text{V}$ (32V for LM611C)	210	300	350	μA max
			221	320	370	μA max
V_S	Supply Voltage Range		2.2	2.8	2.8	V min
			2.9	3	3	V min
			46	36	32	V max
			43	36	32	V max
OPERATIONAL AMPLIFIER						
V_{OS1}	V_{OS} Over Supply	$4\text{V} \leq V^+ \leq 36\text{V}$ ($4\text{V} \leq V^+ \leq 32\text{V}$ for LM611C)	1.5 2.0	3.5 6.0	5.0 7.0	mV max mV max
V_{OS2}	V_{OS} Over V_{CM}	$V_{\text{CM}} = 0\text{V}$ through $V_{\text{CM}} =$ ($V^+ - 1.8\text{V}$), $V^+ = 30\text{V}$, $V^- = 0\text{V}$	1.0 1.5	3.5 6.0	5.0 7.0	mV max mV max
$\frac{V_{\text{OS3}}}{\Delta T}$	Average V_{OS} Drift	(Note 6)	15			$\mu\text{V}/^\circ\text{C}$ max
I_B	Input Bias Current		10	25	35	nA max
			11	30	40	nA max
I_{OS}	Input Offset Current		0.2	4	4	nA max
			0.3	5	5	nA max
$\frac{I_{\text{OS1}}}{\Delta T}$	Average Offset Drift Current		4			$\text{pA}/^\circ\text{C}$
R_{IN}	Input Resistance	Differential	1800			$\text{M}\Omega$
		Common-Mode	3800			$\text{M}\Omega$
C_{IN}	Input Capacitance	Common-Mode	5.7			pF
e_n	Voltage Noise	$f = 100\ \text{Hz}$, Input Referred	74			$\text{nV}/\sqrt{\text{Hz}}$
i_n	Current Noise	$f = 100\ \text{Hz}$, Input Referred	58			$\text{fA}/\sqrt{\text{Hz}}$
CMRR	Common-Mode	$V^+ = 30\text{V}$, $0\text{V} \leq V_{\text{CM}} \leq (V^+ - 1.8\text{V})$	95	80	75	dB min
	Rejection-Ratio	$\text{CMRR} = 20 \log (\Delta V_{\text{CM}}/\Delta V_{\text{OS}})$	90	75	70	dB min

Electrical Characteristics (Continued)

These specifications apply for $V^- = \text{GND} = 0\text{V}$, $V^+ = 5\text{V}$, $V_{\text{CM}} = V_{\text{OUT}} = 2.5\text{V}$, $I_{\text{R}} = 100\ \mu\text{A}$, FEEDBACK pin shorted to GND, unless otherwise specified. Limits in standard typeface are for $T_{\text{J}} = 25^\circ\text{C}$; limits in **boldface type** apply over the **Operating Temperature Range**.

Symbol	Parameter	Conditions	Typical (Note 5)	LM611AM LM611AI Limits (Note 6)	LM611M LM611BI LM611I LM611C Limits (Note 6)	Units
OPERATIONAL AMPLIFIER						
PSRR	Power Supply Rejection-Ratio	$4\text{V} \leq V^+ \leq 30\text{V}$, $V_{\text{CM}} = V^+/2$, $\text{PSRR} = 20 \log (\Delta V^+/\Delta V_{\text{OS}})$	110 100	80 75	75 70	dB min dB min
A_{V}	Open Loop Voltage Gain	$R_{\text{L}} = 10\ \text{k}\Omega$ to GND, $V^+ = 30\text{V}$, $5\text{V} \leq V_{\text{OUT}} \leq 25\text{V}$	500 50	100 40	94 40	V/mV min
SR	Slew Rate	$V^+ = 30\text{V}$ (Note 7)	0.70 0.65	0.55 0.45	0.50 0.45	V/ μs
GBW	Gain Bandwidth	$C_{\text{L}} = 50\ \text{pF}$	0.80 0.50			MHz
V_{O1}	Output Voltage Swing High	$R_{\text{L}} = 10\ \text{k}\Omega$ to GND $V^+ = 36\text{V}$ (32V for LM611C)	$V^+ - 1.4$ $V^+ - 1.6$	$V^+ - 1.7$ $V^+ - 1.9$	$V^+ - 1.8$ $V^+ - 1.9$	V min V min
V_{O2}	Output Voltage Swing Low	$R_{\text{L}} = 10\ \text{k}\Omega$ to V^+ $V^+ = 36\text{V}$ (32V for LM611C)	$V^- + 0.8$ $V^- + 0.9$	$V^- + 0.9$ $V^- + 1.0$	$V^- + 0.95$ $V^- + 1.0$	V max V max
I_{OUT}	Output Source Current	$V_{\text{OUT}} = 2.5\text{V}$, $V_{\text{IN}} = 0\text{V}$, $V_{\text{IN}} = -0.3\text{V}$	25 15	20 13	16 13	mA min mA min
I_{SINK}	Output Sink Current	$V_{\text{OUT}} = 1.6\text{V}$, $V_{\text{IN}} = 0\text{V}$, $V_{\text{IN}} = 0.3\text{V}$	17 9	14 8	13 8	mA min mA min
I_{SHORT}	Short Circuit Current	$V_{\text{OUT}} = 0\text{V}$, $V_{\text{IN}} = 3\text{V}$, $V_{\text{IN}} = 2\text{V}$, Source	30 40	50 60	50 60	mA max mA max
		$V_{\text{OUT}} = 5\text{V}$, $V_{\text{IN}} = 2\text{V}$, $V_{\text{IN}} = 3\text{V}$, Sink	30 32	60 80	70 90	mA max mA max
VOLTAGE REFERENCE						
V_{R}	Reference Voltage	(Note 8)	1.244	1.2365 1.2515 ($\pm 0.6\%$)	1.2191 1.2689 ($\pm 2.0\%$)	V min V max
$\frac{\Delta V_{\text{R}}}{\Delta T_{\text{J}}}$	Average Temperature Drift	(Note 9)	10	80	150	PPM/ $^\circ\text{C}$ max
$\frac{\Delta V_{\text{R}}}{\Delta T_{\text{J}}}$	Hysteresis	Hyst = $(V_{\text{ro}'} - V_{\text{ro}})/\Delta T_{\text{J}}$ (Note 10)	3.2			$\mu\text{V}/^\circ\text{C}$
$\frac{\Delta V_{\text{R}}}{\Delta I_{\text{R}}}$	V_{R} Change with Current	$V_{\text{R}(100\ \mu\text{A})} - V_{\text{R}(17\ \mu\text{A})}$	0.05 0.1	1 1.1	1 1.1	mV max mV max
		$V_{\text{R}(10\ \text{mA})} - V_{\text{R}(100\ \mu\text{A})}$ (Note 11)	1.5 2.0	5 5.5	5 5.5	mV max mV max
R	Resistance	$\Delta V_{\text{R}(10 \rightarrow 0.1\ \text{mA})}/9.9\ \text{mA}$	0.2	0.56	0.56	Ω max
		$\Delta V_{\text{R}(100 \rightarrow 17\ \mu\text{A})}/83\ \mu\text{A}$	0.6	13	13	Ω max
$\frac{\Delta V_{\text{R}}}{V_{\text{RO}}}$	V_{R} Change with High V_{RO}	$V_{\text{R}(V_{\text{ro}} = V_{\text{T}})} - V_{\text{R}(V_{\text{ro}} = 6.3\text{V})}$ (5.06V between Anode and FEEDBACK)	2.5 2.8	7 10	7 10	mV max mV max
$\frac{\Delta V_{\text{R}}}{\Delta V^+}$	V_{R} Change with V^+ Change	$V_{\text{R}(V^+ = 5\text{V})} - V_{\text{R}(V^+ = 36\text{V})}$ ($V^+ = 32\text{V}$ for LM611C)	0.1 0.1	1.2 1.3	1.2 1.3	mV max mV max
		$V_{\text{R}(V^+ = 5\text{V})} - V_{\text{R}(V^+ = 3\text{V})}$	0.01 0.01	1 1.5	1 1.5	mV max mV max

Electrical Characteristics (Continued)

These specifications apply for $V^- = \text{GND} = 0\text{V}$, $V^+ = 5\text{V}$, $V_{\text{CM}} = V_{\text{OUT}} = 2.5\text{V}$, $I_{\text{R}} = 100\ \mu\text{A}$, FEEDBACK pin shorted to GND, unless otherwise specified. Limits in standard typeface are for $T_{\text{J}} = 25^\circ\text{C}$; limits in **boldface type** apply over the **Operating Temperature Range**.

Symbol	Parameter	Conditions	Typical (Note 5)	LM611AM LM611AI Limits (Note 6)	LM611M LM611BI LM611I LM611C Limits (Note 6)	Units
--------	-----------	------------	---------------------	--	---	-------

VOLTAGE REFERENCE

$\frac{\Delta V_{\text{R}}}{\Delta V_{\text{ANODE}}}$	V_{R} Change with V_{ANODE} Change	$V^+ = V^+ \text{ max}$, $\Delta V_{\text{R}} = V_{\text{R}}$ (@ $V_{\text{ANODE}} = V^- = \text{GND}$) - V_{R} (@ $V_{\text{ANODE}} = V^+ - 1.0\text{V}$)	0.7 3.3	1.5 3.0	1.6 3.0	mV max mV max
I_{FB}	FEEDBACK Bias Current	I_{FB} ; $V_{\text{ANODE}} \leq V_{\text{FB}} \leq 5.06\text{V}$	22 29	35 40	50 55	nA max nA max
e_{n}	V_{R} Noise	10 Hz to 10,000 Hz, $V_{\text{RO}} = V_{\text{R}}$	30			μV_{RMS}

Note 1: Absolute maximum ratings indicate limits beyond which damage to the component may occur. Electrical specifications do not apply when operating the device beyond its rated operating conditions.

Note 2: More accurately, it is excessive current flow, with resulting excess heating, that limits the voltages on all pins. When any pin is pulled a diode drop below V^- , a parasitic NPN transistor turns ON. No latch-up will occur as long as the current through that pin remains below the Maximum Rating. Operation is undefined and unpredictable when any parasitic diode or transistor is conducting.

Note 3: Junction temperature may be calculated using $T_{\text{J}} = T_{\text{A}} + P_{\text{D}} \theta_{\text{JA}}$. The given thermal resistance is worst-case for packages in sockets in still air. For packages soldered to copper-clad board with dissipation from one op amp or reference output transistor, nominal θ_{JA} is 90°C/W for the N package and 135°C/W for the M package.

Note 4: Human body model, 100 pF discharged through a 1.5 k Ω resistor.

Note 5: Typical values in standard typeface are for $T_{\text{J}} = 25^\circ\text{C}$; values in **boldface type** apply for the full operating temperature range. These values represent the most likely parametric norm.

Note 6: All limits are guaranteed at room temperature (standard type face) or at operating temperature extremes (**bold face type**).

Note 7: Slew rate is measured with op amp in a voltage follower configuration. For rising slew rate, the input voltage is driven from 5V to 25V, and the output voltage transition is sampled at 10V and 20V. For falling slew rate, the input voltage is driven from 25V to 5V, and output voltage transition is sampled at 20V and 10V.

Note 8: V_{R} is the cathode-feedback voltage, nominally 1.244V.

Note 9: Average reference drift is calculated from the measurement of the reference voltage at 25°C and at the temperature extremes. The drift, in ppm/ $^\circ\text{C}$, is $10^6 \cdot \Delta V_{\text{R}} / (V_{\text{R}} \Delta T_{\text{J}})$, where ΔV_{R} is the lowest value subtracted from the highest, $V_{\text{R}} \Delta T_{\text{J}}$ is the value at 25°C , and ΔT_{J} is the temperature range. This parameter is guaranteed by design and sample testing.

Note 10: Hysteresis is the change in V_{R} caused by a change in T_{J} , after the reference has been "dehysteresized". To dehysteresize the reference; that is minimize the hysteresis to the typical value, its junction temperature should be cycled in the following pattern, spiraling in toward 25°C : 25°C , 85°C , -40°C , 70°C , 0°C , 25°C .

Note 11: Low contact resistance is required for accurate measurement.

Note 12: Military RETS 611AMX electrical test specification is available on request. The LM611AMJ/883 can also be procured as a Standard Military Drawing.

Simplified Schematic Diagrams

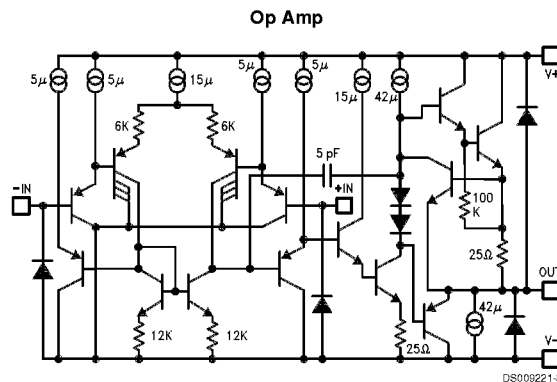

Simplified Schematic Diagrams (Continued)

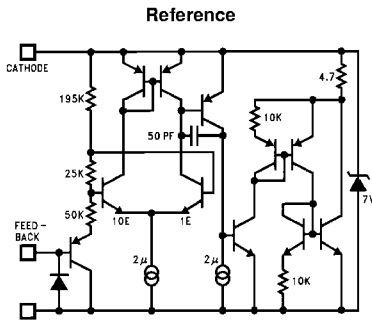

DS009221-01

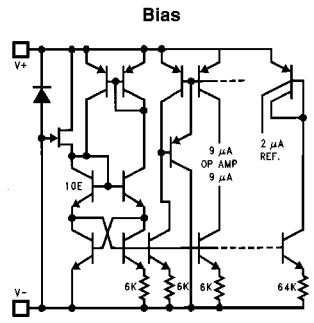

DS009221-02

Typical Performance Characteristics (Reference) $T_J = 25^\circ\text{C}$, FEEDBACK pin shorted to $V^- = 0\text{V}$, unless otherwise noted

Reference Voltage vs Temp on 5 Representative Units

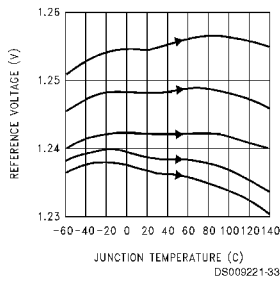

DS009221-33

Reference Voltage Drift

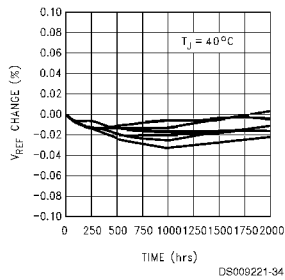

DS009221-34

Accelerated Reference Voltage Drift vs Time

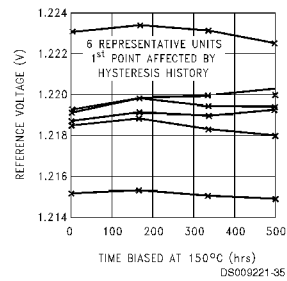

DS009221-35

Reference Voltage vs Current and Temperature

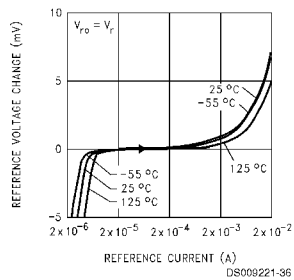

DS009221-36

Reference Voltage vs Current and Temperature

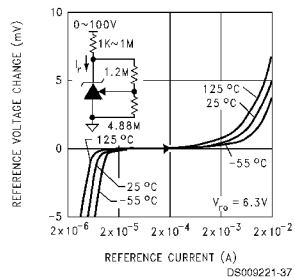

DS009221-37

Reference Voltage vs Reference Current

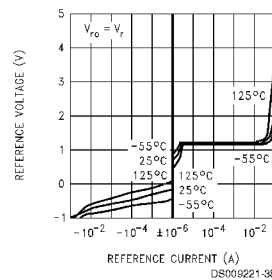

DS009221-38

Typical Performance Characteristics (Reference) $T_J = 25^\circ\text{C}$, FEEDBACK pin shorted to $V^- = 0\text{V}$, unless otherwise noted (Continued)

Reference Voltage vs Reference Current

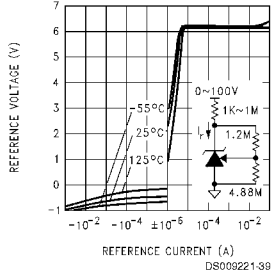

Reference AC Stability Range

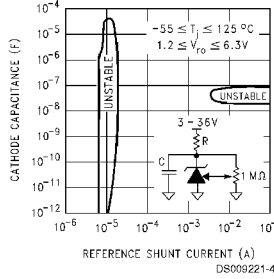

Feedback Current vs Feedback-to-Anode Voltage

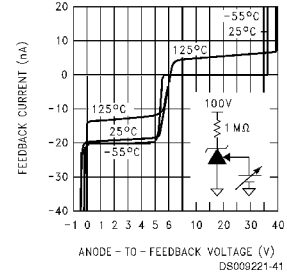

Feedback Current vs Feedback-to-Anode Voltage

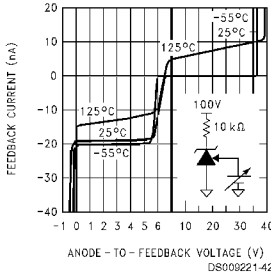

Reference Noise Voltage vs Frequency

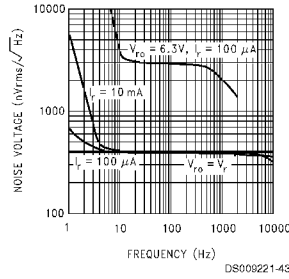

Reference Small-Signal Resistance vs Frequency

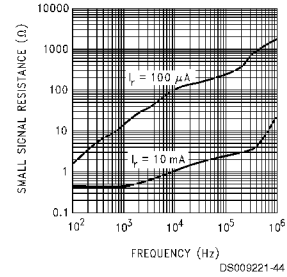

Reference Power-Up Time

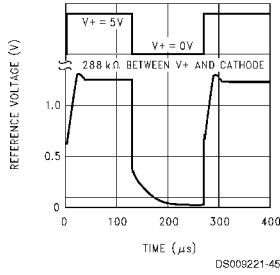

Reference Voltage with Feedback Voltage Step

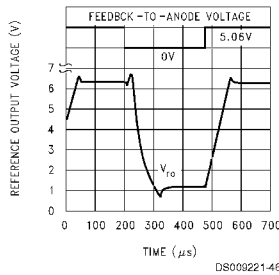

Reference Voltage with 100 ~ 12 µA Current Step

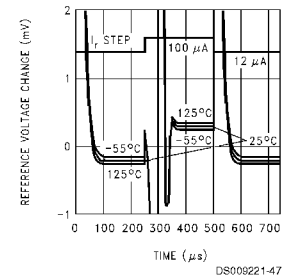

Typical Performance Characteristics (Reference) $T_J = 25^\circ\text{C}$, FEEDBACK pin shorted to $V^- = 0\text{V}$, unless otherwise noted (Continued)

Reference Step Response for $100\ \mu\text{A} \sim 10\ \text{mA}$ Current Step

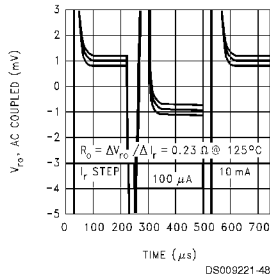

Reference Voltage Change with Supply Voltage Step

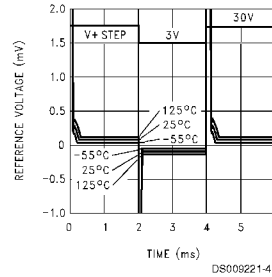

Typical Performance Characteristics (Op Amps) $V^+ = 5\text{V}$, $V^- = \text{GND} = 0\text{V}$, $V_{CM} = V^+/2$, $V_{OUT} = V^+/2$, $T_J = 25^\circ\text{C}$, unless otherwise noted

Input Common-Mode Voltage Range vs Temperature

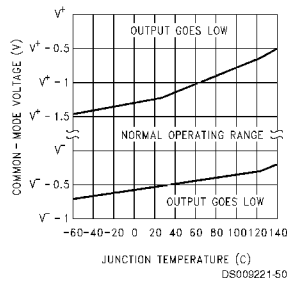

V_{OS} vs Junction Temperature

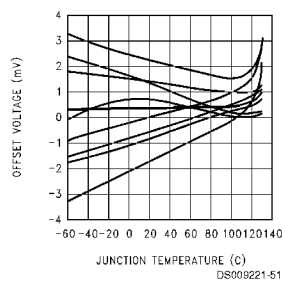

Input Bias Current vs Common-Mode Voltage

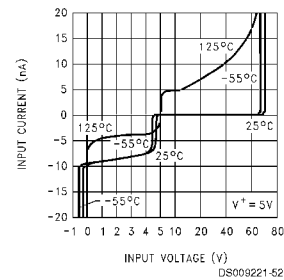

Reference Change vs Common-Mode Voltage

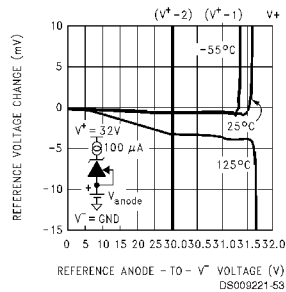

Large-Signal Step Response

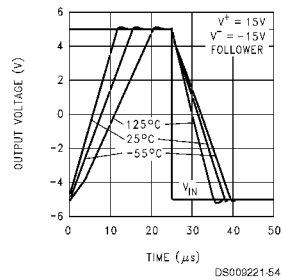

Output Voltage Swing vs Temp. and Current

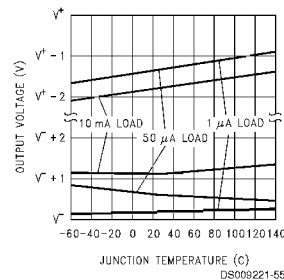

Typical Performance Characteristics (Op Amps) $V^+ = 5V, V^- = GND = 0V, V_{CM} = V^+/2,$
 $V_{OUT} = V^+/2, T_J = 25^\circ C,$ unless otherwise noted (Continued)

Output Source Current vs Output Voltage and Temp.

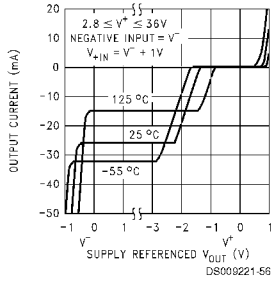

Output Sink Current vs Output Voltage

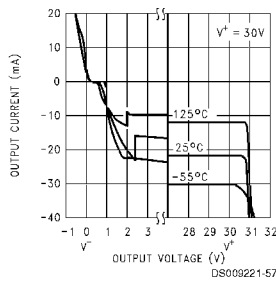

Output Swing, Large Signal

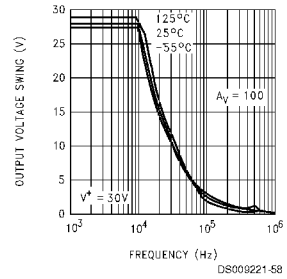

Output Impedance vs Frequency and Gain

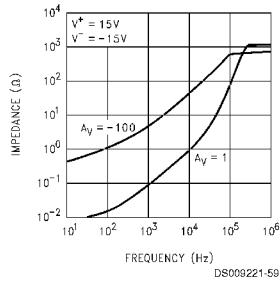

Small Signal Pulse Response vs Temp.

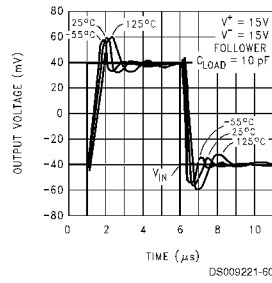

Small-Signal Pulse Response vs Load

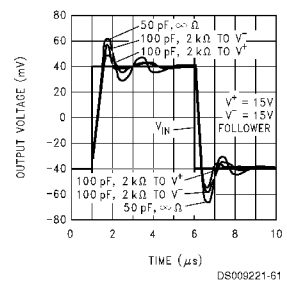

Op Amp Voltage Noise vs Frequency

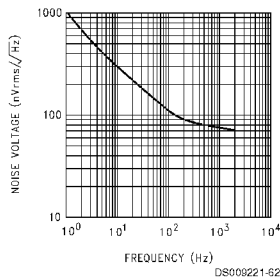

Op Amp Current Noise vs Frequency

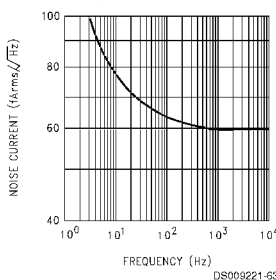

Small-Signal Voltage Gain vs Frequency and Temperature

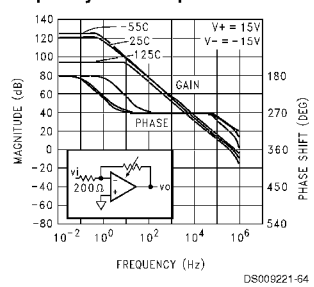

Typical Performance Characteristics (Op Amps) $V^+ = 5V$, $V^- = GND = 0V$, $V_{CM} = V^+/2$, $V_{OUT} = V^+/2$, $T_J = 25^\circ C$, unless otherwise noted (Continued)

Small-Signal Voltage Gain vs Frequency and Load

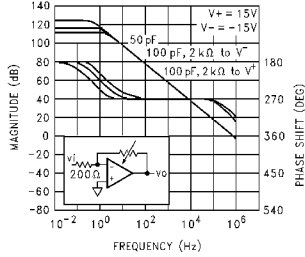

Follower Small-Signal Frequency Response

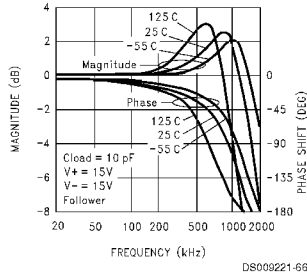

Common-Mode Input Voltage Rejection Ratio

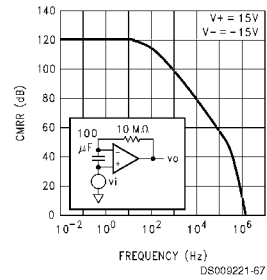

Power Supply Current vs Power Supply Voltage

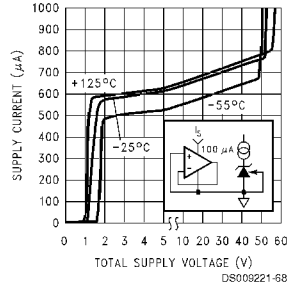

Positive Power Supply Voltage Rejection Ratio

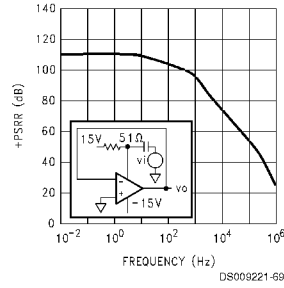

Negative Power Supply Voltage Rejection Ratio

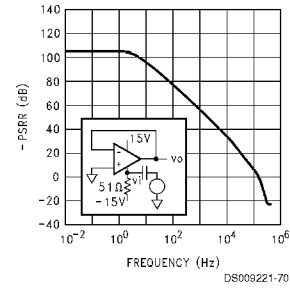

Slew Rate vs Temperature

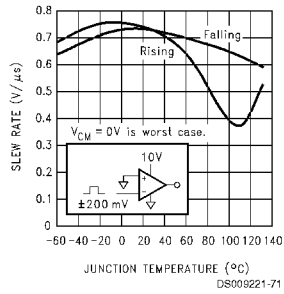

Input Offset Current vs Junction Temperature

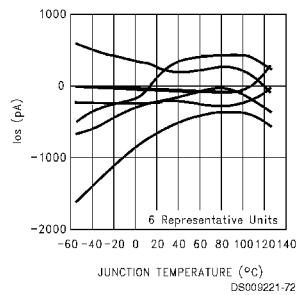

Input Bias Current vs Junction Temperature

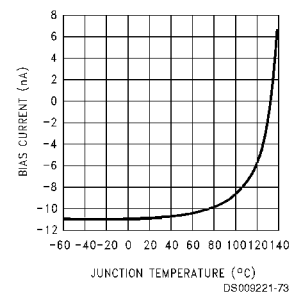

Typical Performance Distributions

**Average V_{OS} Drift
Military Temperature Range**

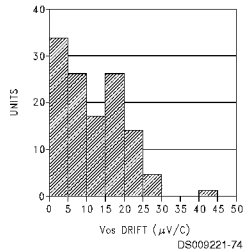

**Average V_{OS} Drift
Industrial Temperature Range**

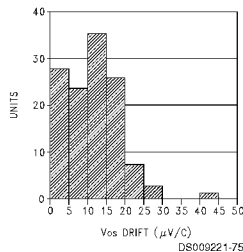

**Average V_{OS} Drift
Commercial Temperature Range**

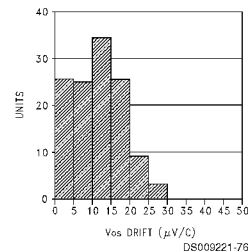

**Average I_{OS} Drift
Military Temperature Range**

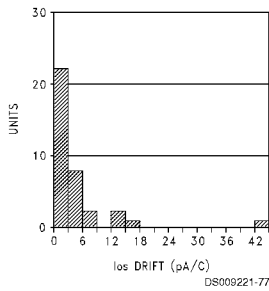

**Average I_{OS} Drift
Industrial Temperature Range**

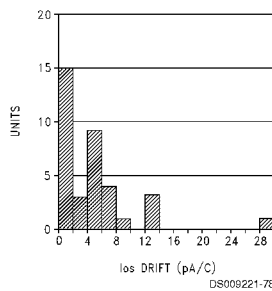

**Average I_{OS} Drift
Commercial Temperature Range**

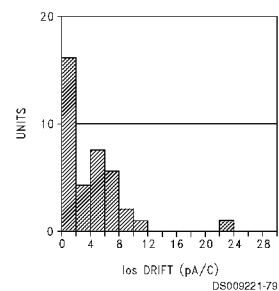

**Voltage Reference Broad-Band
Noise Distribution**

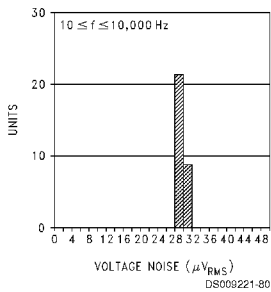

**Op Amp Voltage
Noise Distribution**

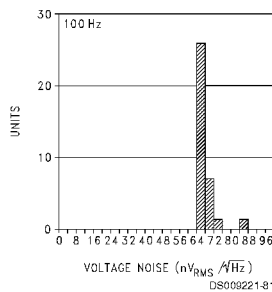

**Op Amp Current
Noise Distribution**

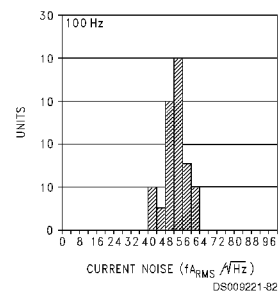

Application Information

VOLTAGE REFERENCE

Reference Biasing

The voltage reference is of a shunt regulator topology that models as a simple zener diode. With current I_r flowing in the 'forward' direction there is the familiar diode transfer function. I_r flowing in the reverse direction forces the reference voltage to be developed from cathode to anode. The applied voltage to the cathode may range from a diode drop below V^- to the reference voltage or to the avalanche voltage of the parallel protection diode, nominally 7V. A 6.3V reference with $V^+ = 3V$ is allowed.

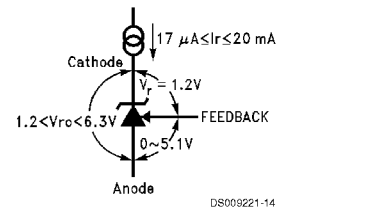

**FIGURE 1. Voltages Associated with Reference
(Current Source I_r is External)**

Application Information (Continued)

The reference equivalent circuit reveals how V_r is held at the constant 1.2V by feedback, and how the FEEDBACK pin passes little current.

To generate the required reverse current, typically a resistor is connected from a supply voltage higher than the reference voltage. Varying that voltage, and so varying I_r , has small effect with the equivalent series resistance of less than an ohm at the higher currents. Alternatively, an active current source, such as the LM134 series, may generate I_r .

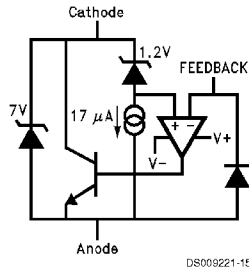

FIGURE 2. Reference Equivalent Circuit

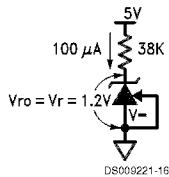

FIGURE 3. 1.2V Reference

Capacitors in parallel with the reference are allowed. See the Reference AC Stability Range curve for capacitance values—from 20 μ A to 3 mA any capacitor value is stable. With the reference's wide stability range with resistive and capacitive loads, a wide range of RC filter values will perform noise filtering.

Adjustable Reference

The FEEDBACK pin allows the reference output voltage, V_{ro} , to vary from 1.24V to 6.3V. The reference attempts to hold V_r at 1.24V. If V_r is above 1.24V, the reference will conduct current from Cathode to Anode; FEEDBACK current always remains low. If FEEDBACK is connected to Anode, then $V_{ro} = V_r = 1.24V$. For higher voltages FEEDBACK is held at a constant voltage above Anode—say 3.76V for $V_{ro} = 5V$. Connecting a resistor across the constant V_r generates a current $I = R1/V_r$ flowing from Cathode into FEEDBACK node. A Thevenin equivalent 3.76V is generated from FEEDBACK to Anode with $R2 = 3.76/I$. Keep I greater than one thousand times larger than FEEDBACK bias current for $<0.1\%$ error— $I \geq 32 \mu A$ for the military grade over the military temperature range ($\geq 5.5 \mu A$ for a 1% untrimmed error for a commercial part.)

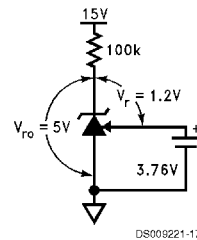
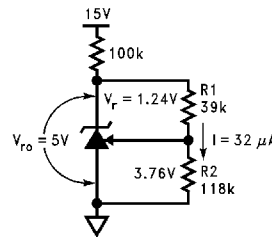

FIGURE 4. Thevenin Equivalent of Reference with 5V Output



$$R1 = Vr/I = 1.24/32\mu = 39k$$

$$R2 = R1 \{ (Vro/Vr) - 1 \} = 39k \{ (5/1.24) - 1 \} = 118k$$

FIGURE 5. Resistors R1 and R2 Program Reference Output Voltage to be 5V

Understanding that V_r is fixed and that voltage sources, resistors, and capacitors may be tied to the FEEDBACK pin, a range of V_r temperature coefficients may be synthesized.

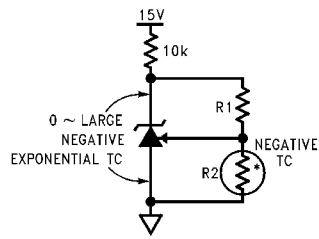

FIGURE 6. Output Voltage has Negative Temperature Coefficient (TC) if R2 has Negative TC

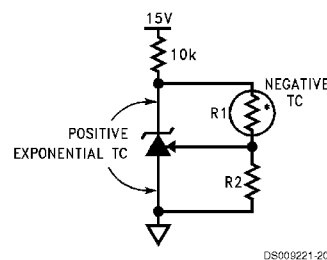

FIGURE 7. Output Voltage has Positive Temperature Coefficient (TC) if R1 has Negative TC

Application Information (Continued)

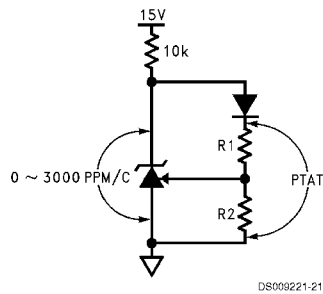
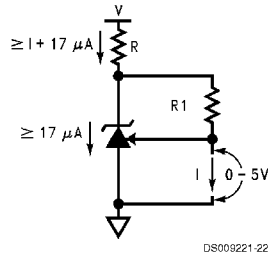

FIGURE 8. Diode in Series with R1 Causes Voltage Across R1 and R2 to be Proportional to Absolute Temperature (PTAT)

Connecting a resistor across Cathode-to-FEEDBACK creates a 0 TC current source, but a range of TCs may be synthesized.



$$I = Vr/R1 = 1.24/R1$$

FIGURE 9. Current Source is Programmed by R1

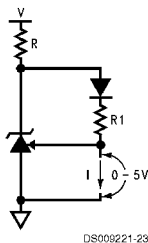

FIGURE 10. Proportional-to-Absolute-Temperature Current Source

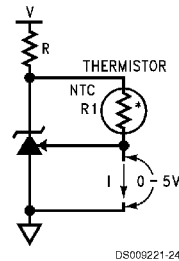

FIGURE 11. Negative -TC Current Source

Hysteresis

The reference voltage depends, slightly, on the thermal history of the die. Competitive micro-power products vary—always check the data sheet for any given device. Do not assume that no specification means no hysteresis.

OPERATIONAL AMPLIFIER

The amp or the reference may be biased in any way with no effect on the other, except when a substrate diode conducts (see Guaranteed Electrical Characteristics Note 1). The amp may have inputs outside the common-mode range, may be operated as a comparator, or have all terminals floating with no effect on the reference (tying inverting input to output and non-inverting input to V^- on unused amp is preferred). Choosing operating points that cause oscillation, such as driving too large a capacitive load, is best avoided.

Op Amp Output Stage

The op amp, like the LM124 series, has a flexible and relatively wide-swing output stage. There are simple rules to optimize output swing, reduce cross-over distortion, and optimize capacitive drive capability:

1. Output Swing: Unloaded, the 42 μA pull-down will bring the output within 300 mV of V^- over the military temperature range. If more than 42 μA is required, a resistor from output to V^- will help. Swing across any load may be improved slightly if the load can be tied to V^+ , at the cost of poorer sinking open-loop voltage gain.
2. Cross-over Distortion: The LM611 has lower cross-over distortion (a 1 V_{BE} deadband versus 3 V_{BE} for the LM124), and increased slew rate as shown in the characteristic curves. A resistor pull-up or pull-down will force class-A operation with only the PNP or NPN output transistor conducting, eliminating cross-over distortion.
3. Capacitive Drive: Limited by the output pole caused by the output resistance driving capacitive loads, a pull-down resistor conducting 1 mA or more reduces the output stage NPN r_o until the output resistance is that of the current limit 25 Ω . 200 pF may then be driven without oscillation.

Op Amp Input Stage

The lateral PNP input transistors, unlike those of most op amps, have BV_{EBO} equal to the absolute maximum supply voltage. Also, they have no diode clamps to the positive supply nor across the inputs. These features make the inputs look like high impedances to input sources producing large differential and common-mode voltages.

Typical Applications

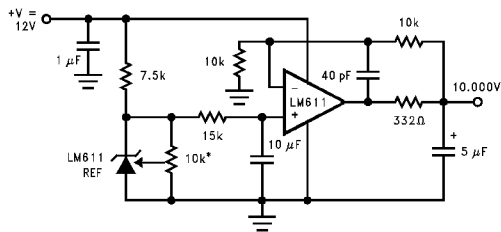

DS009221-28

*10k must be low
t.c. trim pot.

FIGURE 12. Ultra Low Noise 10.000V Reference.
Total Output Noise is Typically $14 \mu\text{V}_{\text{RMS}}$.
Adjust the 10k pot for 10.000V.

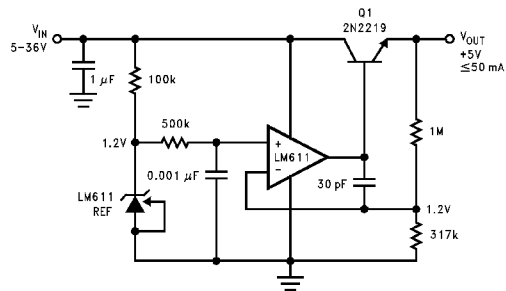

DS009221-30

FIGURE 13. Simple Low Quiescent Drain Voltage Regulator. Total Supply Current is approximately $320 \mu\text{A}$ when $V_{\text{IN}} = 5\text{V}$, and output has no load.

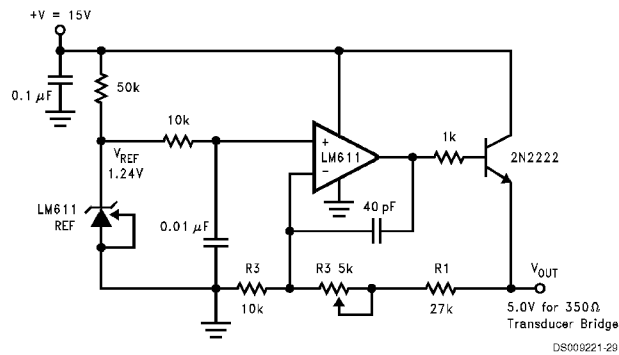

DS009221-29

$V_{\text{OUT}} = (R1/R2 + 1) V_{\text{REF}}$.
R1, R2 should be 1% metal film.
R3 should be low t.c. trim pot.

FIGURE 14. Slow Rise-Time Upon Power-Up, Adjustable Transducer Bridge Driver.
Rise-time is approximately 0.5 ms.

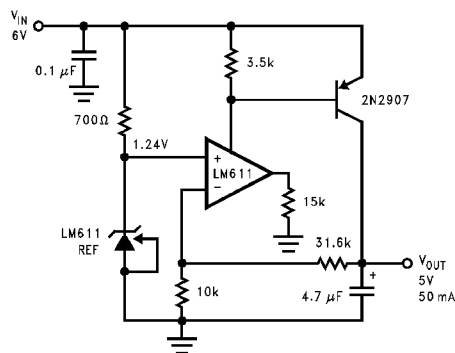

DS009221-31

FIGURE 15. Low Drop-Out Voltage Regulator Circuit. Drop out voltage is typically 0.2V.

Typical Applications (Continued)

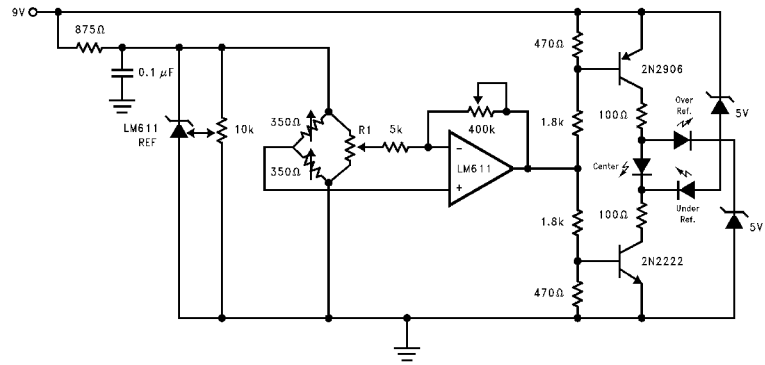

DS009221-32

FIGURE 16. Nulling Bridge Detection System. Adjust sensitivity via 400 kΩ pot. Null offset with R1, and bridge drive with the 10k pot.

Ordering Information

Reference Tolerance & V_{OS}	Temperature Range			Package	NSC Drawing
	Military $-55^{\circ}\text{C} \leq T_A \leq +125^{\circ}\text{C}$	Industrial $-40^{\circ}\text{C} \leq T_A \leq +85^{\circ}\text{C}$	Commercial $0^{\circ}\text{C} \leq T_A \leq +70^{\circ}\text{C}$		
$\pm 0.6\%$ @ 80 ppm/ $^{\circ}\text{C}$ max $V_{OS} = 3.5\text{ mV}$ max	LM611AMN	LM611AIN	—	8-pin molded DIP	N08E
	LM611AMJ/883 (Note 12)	—	—	8-pin ceramic DIP	J08A
$\pm 2.0\%$ @ 150 ppm/ $^{\circ}\text{C}$ max $V_{OS} = 5\text{ mV}$ max	LM611MN	LM611BIN	LM611CN	8-pin molded DIP	N08E
	—	LM611IM	LM611CM	14-pin Narrow Surface Mount	M14A

Physical Dimensions inches (millimeters) unless otherwise noted

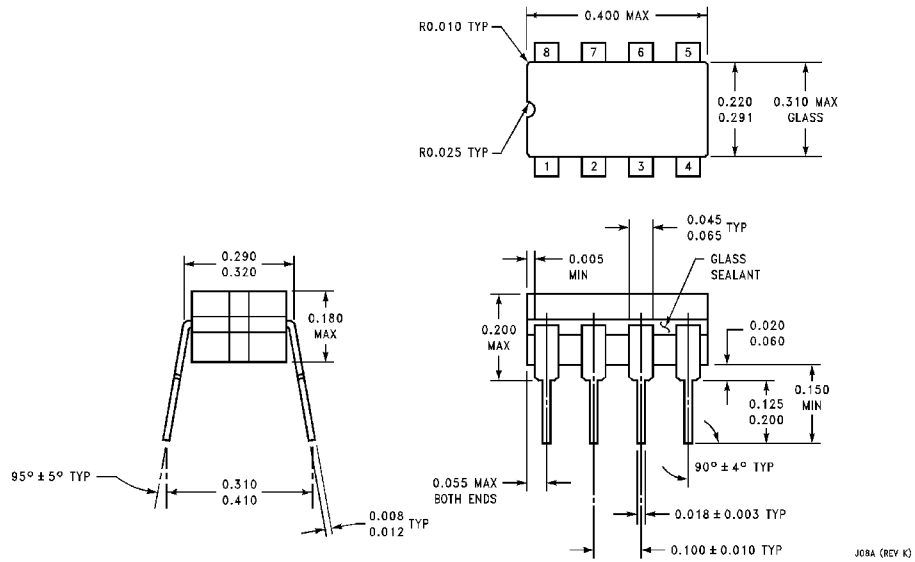

Hermetic Dual-In-Line Package (J)
Order Number LM611AMJ/883
NS Package Number J08A

J08A (REV K)

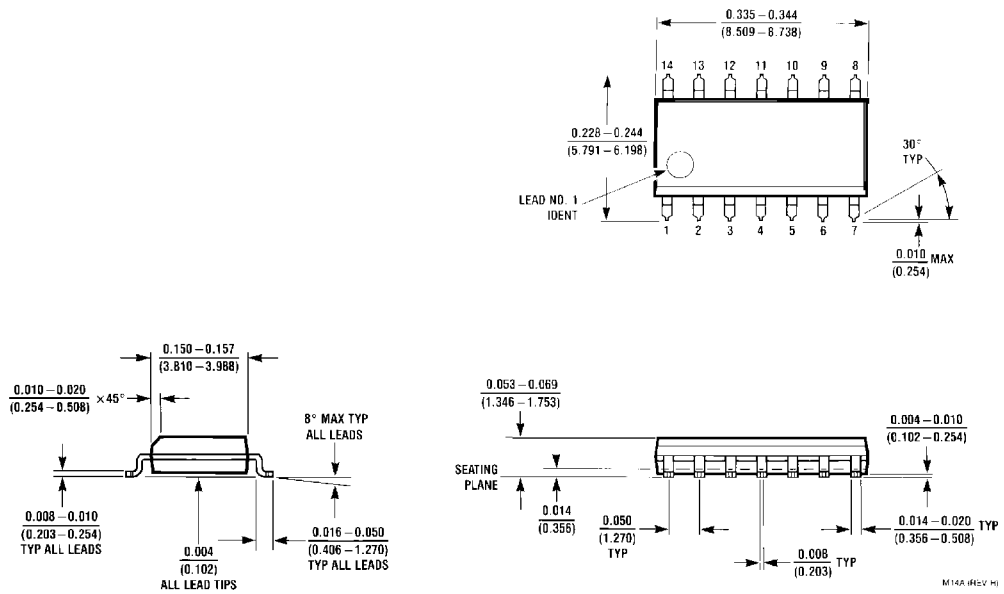

Plastic Surface Mount Narrow Package (0.15) (M)
Order Number LM611CM or LM611IM
NS Package Number M14A

M14A (REV H)

Physical Dimensions inches (millimeters) unless otherwise noted (Continued)

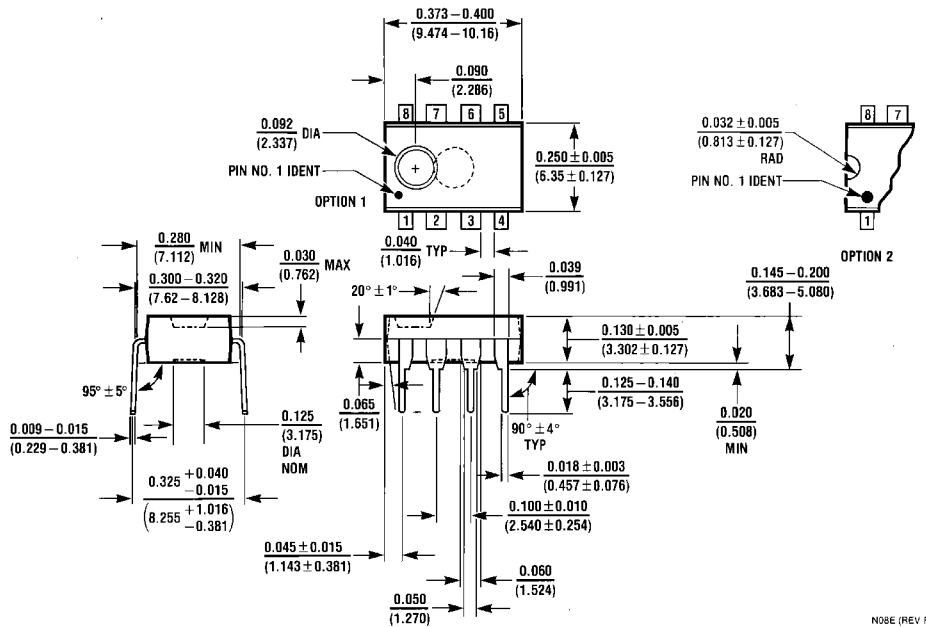

Plastic Dual-In-Line Package (N)
 Order Number LM611CN, LM611AIN, LM611BIN, LM611AMN or LM611MN
 NS Package Number N08E

LIFE SUPPORT POLICY

NATIONAL'S PRODUCTS ARE NOT AUTHORIZED FOR USE AS CRITICAL COMPONENTS IN LIFE SUPPORT DEVICES OR SYSTEMS WITHOUT THE EXPRESS WRITTEN APPROVAL OF THE PRESIDENT OF NATIONAL SEMICONDUCTOR CORPORATION. As used herein:

1. Life support devices or systems are devices or systems which, (a) are intended for surgical implant into the body, or (b) support or sustain life, and whose failure to perform when properly used in accordance with instructions for use provided in the labeling, can be reasonably expected to result in a significant injury to the user.
2. A critical component is any component of a life support device or system whose failure to perform can be reasonably expected to cause the failure of the life support device or system, or to affect its safety or effectiveness.

National Semiconductor Corporation
 Americas
 Tel: 1-800-272-9959
 Fax: 1-800-737-7018
 Email: support@nsc.com

National Semiconductor Europe
 Fax: +49 (0) 1 80-530 85 86
 Email: europe.support@nsc.com
 Deutsch Tel: +49 (0) 1 80-530 85 85
 English Tel: +49 (0) 1 80-532 78 32
 Français Tel: +49 (0) 1 80-532 93 58
 Italiano Tel: +49 (0) 1 80-534 16 80

National Semiconductor Asia Pacific Customer Response Group
 Tel: 65-2544466
 Fax: 65-2504466
 Email: sea.support@nsc.com

National Semiconductor Japan Ltd.
 Tel: 81-3-5639-7560
 Fax: 81-3-5639-7507

www.national.com