

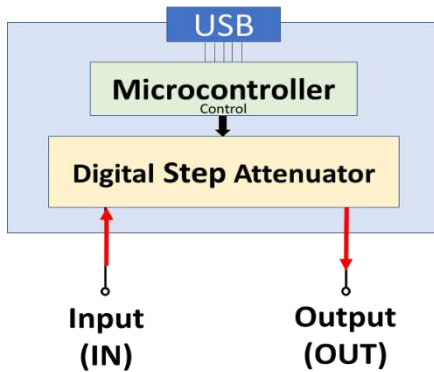

RoHS Compliant



Electrical Schematic

Insertion Loss Compensated

No Extra Insertion Loss

Setting Attenuation = Actual Attenuation

Note: When the "compensate I.L." is set "ON", and the frequency and wanted attenuation value is specified, the attenuator will automatically calculate the required additional attenuation value according to the corresponding insertion loss. The final attenuation value will be very close to wanted attenuation value.

Outline Drawing

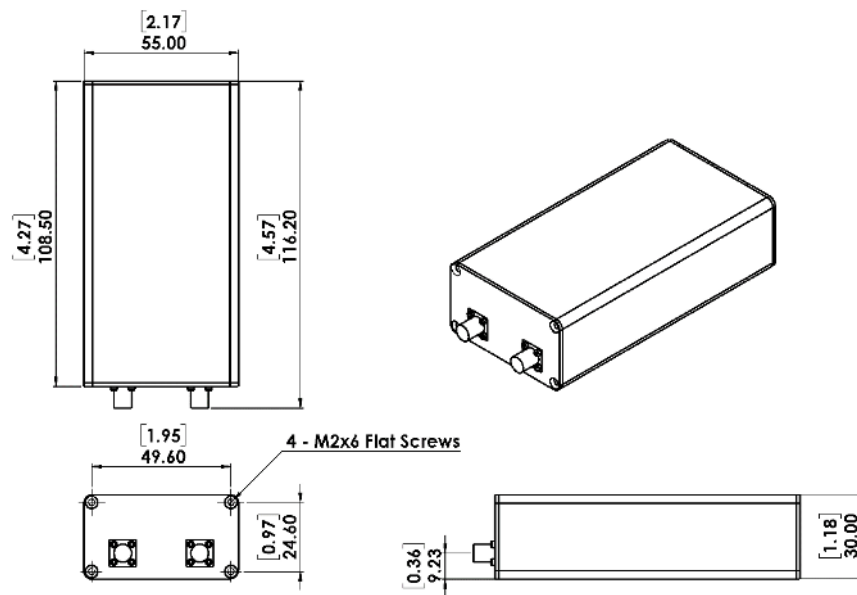

Connectors: 2.92mm Female, USB (Micro-B)

Electrical Specifications

Parameter		Unit	Frequency (MHz)	Conditions	Min.	Typ.	Max.	
Attenuation Range		dB	10 - 30000		0		31.5	
Step		dB				0.5		
Insertion Loss (I.L.)		dB		@ 0 dB Att.		5.6	5.9	
Attenuation Accuracy	Compensate I.L. "OFF" <i>Note1</i> (I.L. Excluded)	dB		@ 0.5 - 15 dB Att.	± (0.2 + 2% of state) (max.)			
				@ 16 - 31.5 dB Att.	± (0.2 + 4% of state) (max.)			
	Compensate I.L. "ON" <i>Note2</i> (I.L. Included)	dB		I.L. ≤ Att. ≤ 31.5dB		± 0.45	± 0.50	
Input Operating Power (RF In and RF Out ports)		dBm					27	
IP3 Input		dBm				48		
VSWR		:1			@ 0 dB Att.	Input	1.44	1.52
						Output	1.37	
Switching Speed		us			10% to 90% RF Output		1.3	
					50% Control to 90% RF Output		3.24	
Supply Voltage		V			USB port		5	
Supply Current		mA		USB port		10		

Operated in 50Ω system, 25°C environment.

Note1 Max accuracy is relative to attenuation setting value EXCLUDING insertion loss while "Compensate I.L." setting is "OFF".

Note2 Max accuracy is relative to attenuation setting value INCLUDING insertion loss while "Compensate I.L." setting is "ON".

Attenuation relative to Insertion Loss

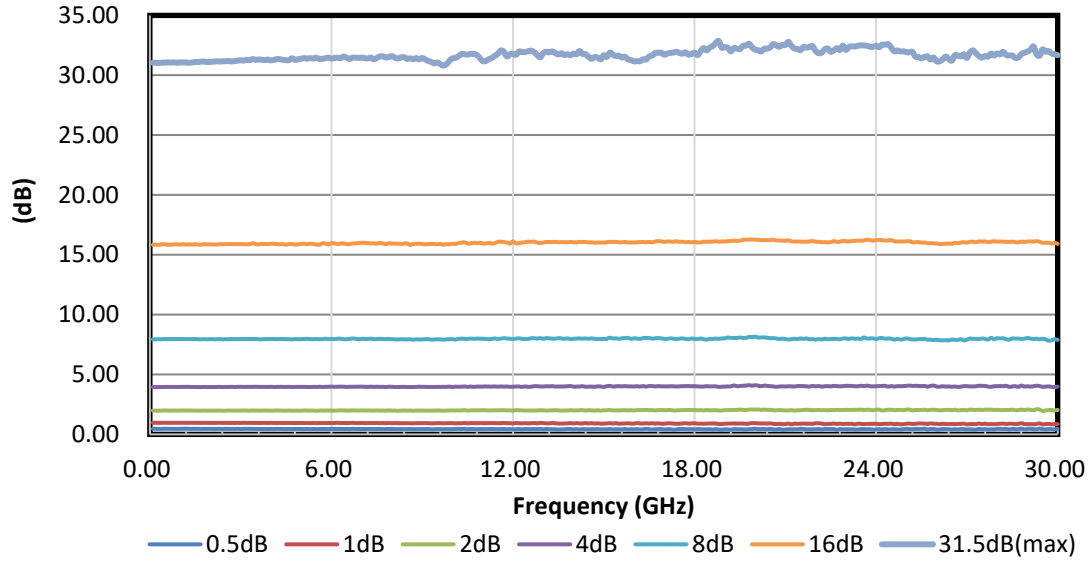

Insertion Loss

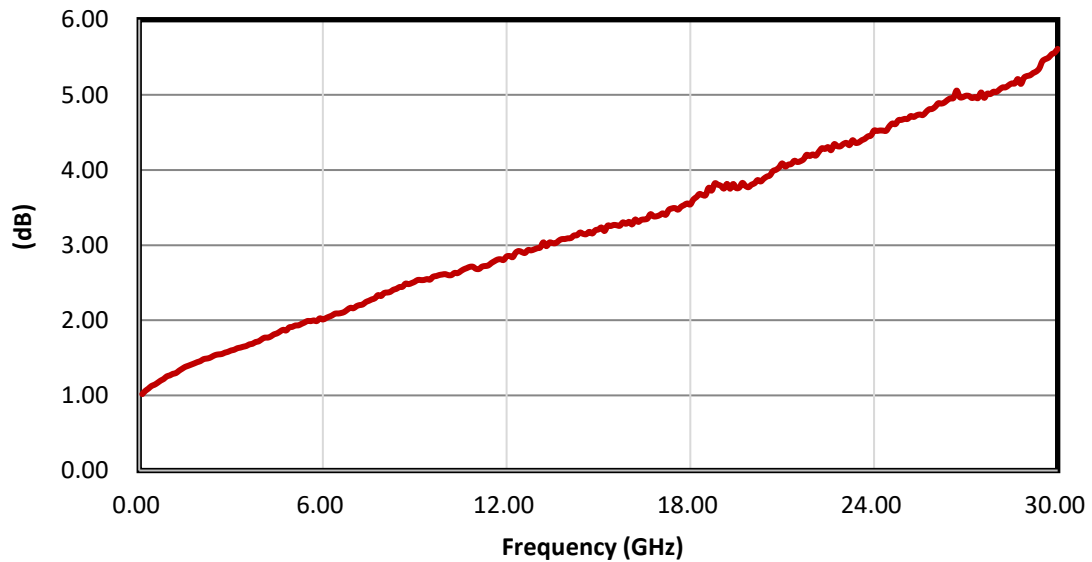

Input VSWR

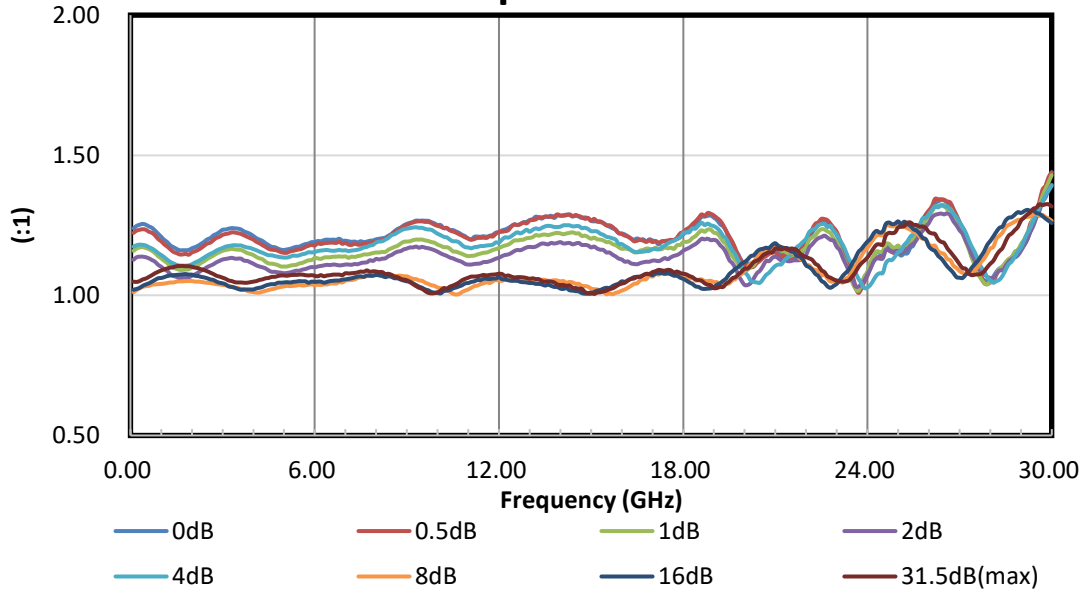

Output VSWR

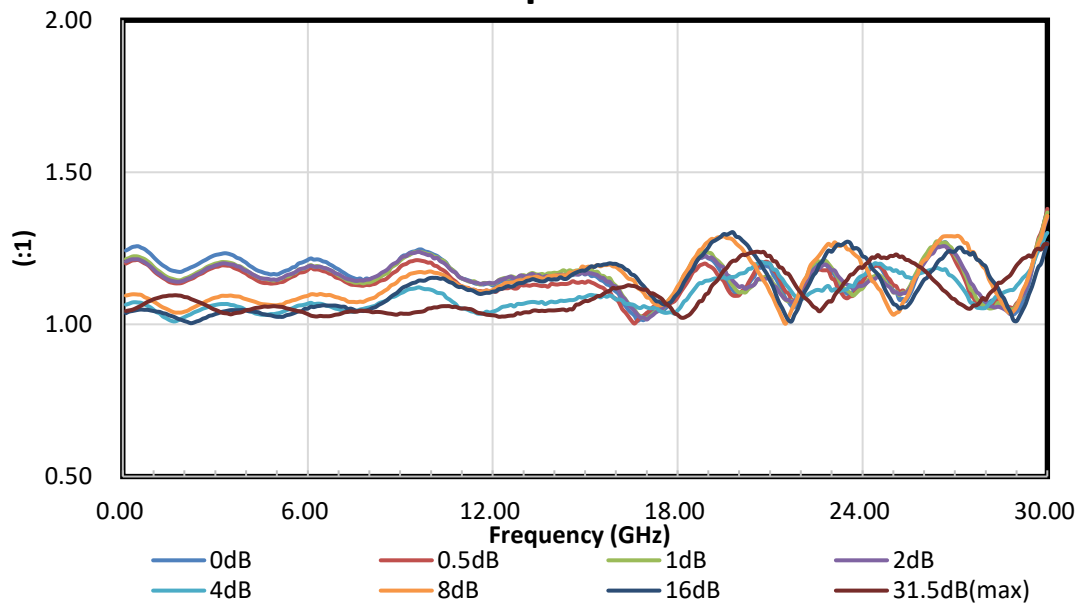

Typical Attenuation Accuracy

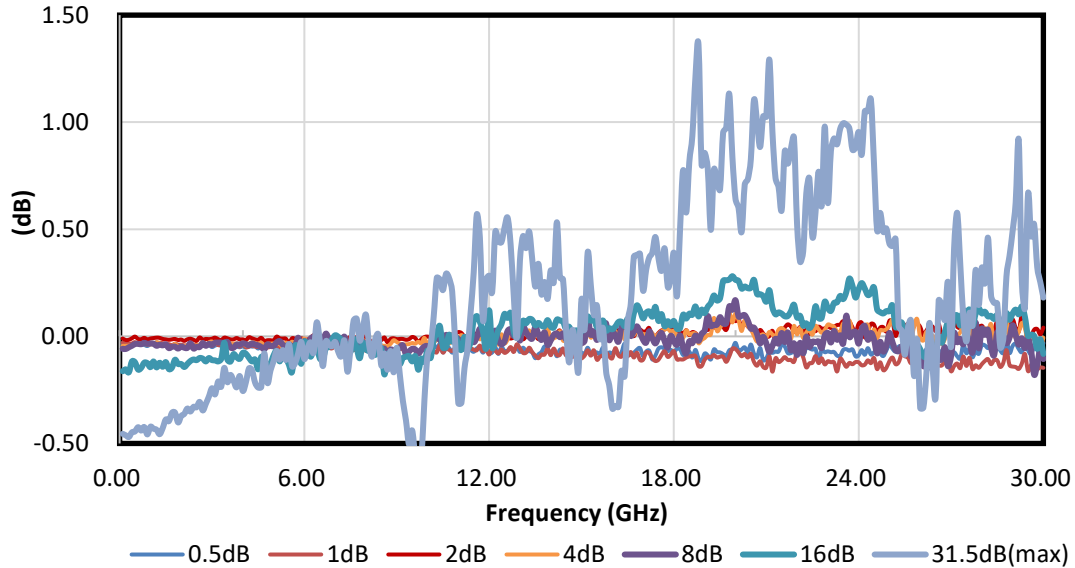

Amtery Graphical User Interface (GUI)

Annotations:

- title and version number
- pull down COM port selection
- information column
- attenuation setting value INCLUDING insertion loss while "Compensate I.L." setting is "ON"
- information table: Users key-in desired setting here, and the device current setting also displayed.
- four operation buttons

Channel	Attenuation (dB)	Frequency (MHz)	Compensate Insertion Loss
1	30	1000	<input checked="" type="checkbox"/>
			<input type="checkbox"/>
			<input type="checkbox"/>
			<input type="checkbox"/>

Software Support: <https://www.amtery.com/data/files/Software.zip>

User manual: <http://www.amtery.com/data/files/User%20Manual.pdf>

Attenuation including Insertion Loss

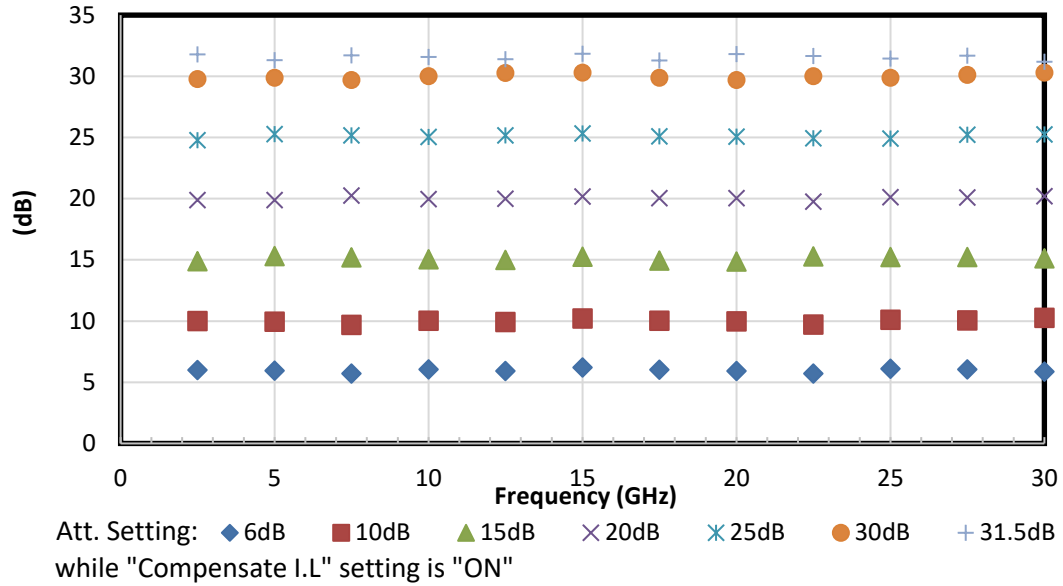

Typical Attenuation Accuracy with Insertion Loss Compensated

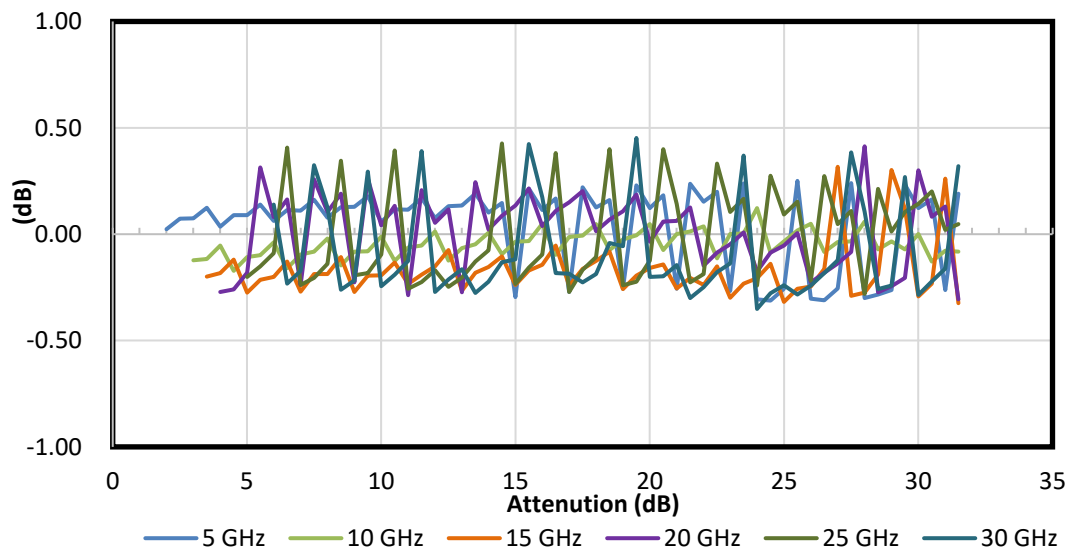

Typical performance S-parameter file: <https://www.amtery.com/en/goods-91>

For each S/N S-parameter file, go to <https://www.amtery.com/en/downloads>

Note: Specifications are subject to change without notice.