

## High temperature 30 A, 600 V TO220 insulated thyristor SCRs

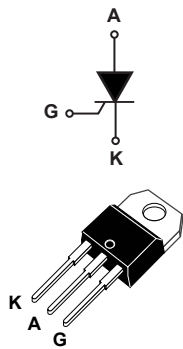

TO-220AB insulated

### Features

- High junction temperature:  $T_j = 150\text{ °C}$
- High noise immunity  $dV/dt = 1000\text{ V}/\mu\text{s}$  up to  $150\text{ °C}$
- Peak off-state voltage  $V_{DRM}/V_{RRM} = 600\text{ V}$
- High turn-on current rise  $dI/dt = 100\text{ A}/\mu\text{s}$
- ECOPACK2 compliant
- Insulated package TO-220AB:
  - Insulated voltage:  $2500\text{ V}_{RMS}$
  - Complies with UL 1557 (File ref : E81734)

### Applications

- General purpose AC line load switching
- Motorbike voltage regulator circuits
- Inrush current limiting circuits
- Motor control circuits and starters
- Heating resistor control, Solid State Relays
- Lighting

### Description

Thanks to its operating junction temperature up to  $150\text{ °C}$ , the TN3015H-6I offers high thermal performance operation up to 30 A rms.

Its trade-off noise immunity ( $dV/dt = 1000\text{ V}/\mu\text{s}$ ) versus its gate triggering current ( $I_{GT} = 15\text{ mA}$ ) and its turn-on current rise ( $dI/dt = 100\text{ A}/\mu\text{s}$ ) allows to design robust and compact control circuit for voltage regulator in motorbikes and industrial drives, overvoltage crowbar protection, motor control circuits in power tools and kitchen appliances and inrush current limiting circuits.

Product status	
TN3015H-6I	
Product summary	
Order code	TN3015H-6I
Package	TO-220AB Ins.
$V_{DRM}/V_{RRM}$	600 V
$T_j$	$150\text{ °C}$
$I_{GT}$	15 mA

# 1 Characteristics

**Table 1. Absolute maximum ratings (limiting values)**

Symbol	Parameter		Value	Unit
$I_{T(RMS)}$	RMS on-state current (180 ° conduction angle)		$T_c = 96\text{ °C}$ 30	A
$I_{T(AV)}$	Average on-state current (180 ° conduction angle)		$T_c = 96\text{ °C}$ 19	A
			$T_c = 111\text{ °C}$ 15	
			$T_c = 127\text{ °C}$ 10	
$I_{TSM}$	Non repetitive surge peak on-state current ( $T_j$ initial = 25 °C)		$t_p = 8.3\text{ ms}$ 295	A
			$t_p = 10\text{ ms}$ 270	
$I^2t$	$I^2t$ value for fusing ( $T_j$ initial = 25 °C)		$t_p = 10\text{ ms}$ 364	A <sup>2</sup> s
$di/dt$	$I_G = 2 \times I_{GT}$ , $tr \leq 100\text{ ns}$ Critical rate of rise of on-state current	$f = 60\text{ Hz}$	$T_j = 25\text{ °C}$ 100	A/ $\mu$ s
$V_{DRM}/V_{RRM}$	Repetitive peak off-state voltage		600	V
$V_{DSM}/V_{RSM}$	Non repetitive surge peak off-state voltage	$t_p = 10\text{ ms}$	$T_j = 25\text{ °C}$ $V_{DRM}/V_{RRM} + 100$	V
$I_{GM}$	Peak gate current	$t_p = 20\text{ }\mu\text{s}$	$T_j = 150\text{ °C}$ 4	A
$P_{G(AV)}$	Average gate power dissipation		$T_j = 150\text{ °C}$ 1	W
$V_{RGM}$	Maximum peak reverse gate voltage		$T_j = 25\text{ °C}$ 5	V
$T_{stg}$	Storage junction temperature range		-40 to +150	°C
$T_j$	Maximum operating junction temperature		-40 to +150	°C
$T_l$	Maximum lead temperature soldering during 10 s		260	°C
$V_{ins}$	Insulation RMS voltage, 1 minute		2500	V

**Table 2. Electrical characteristics ( $T_j = 25\text{ °C}$  unless otherwise specified)**

Symbol	Test conditions		Value	Unit
$I_{GT}$	$V_D = 12\text{ V}$ , $R_L = 33\text{ }\Omega$		Min. 6	mA
			Max. 15	
$V_{GT}$			Max. 1.3	V
$V_{GD}$	$V_D = V_{DRM}$ , $R_L = 3.3\text{ k}\Omega$	$T_j = 150\text{ °C}$	Min. 0.15	V
$I_H$	$I_T = 500\text{ mA}$ , gate open		Max. 60	mA
$I_L$	$I_G = 1.2 \times I_{GT}$		Max. 75	mA
$dV/dt$	$V_D = 402\text{ V}$ , gate open	$T_j = 150\text{ °C}$	Min. 1000	V/ $\mu$ s
$t_{gt}$	$I_T = 60\text{ A}$ , $V_D = 600\text{ V}$ , $I_G = 100\text{ mA}$ , $(di/dt)_{max} = 0.2\text{ A}/\mu\text{s}$		Typ. 1.9	$\mu\text{s}$
$t_q$	$I_T = 30\text{ A}$ , $V_D = 402\text{ V}$ , $(di/dt)_{off} = 30\text{ A}/\mu\text{s}$ , $V_R = 25\text{ V}$ , $dV_D/dt = 50\text{ V}/\mu\text{s}$	$T_j = 150\text{ °C}$	Typ. 80	$\mu\text{s}$

**Table 3. Static characteristics**

Symbol	Test conditions			Value	Unit
$V_{TM}$	$I_{TM} = 60 \text{ A}$ , $t_p = 380 \text{ } \mu\text{s}$	$T_j = 25 \text{ }^\circ\text{C}$	Max.	1.6	V
$V_{TO}$	Threshold voltage	$T_j = 150 \text{ }^\circ\text{C}$	Max.	0.84	
$R_D$	Dynamic resistance	$T_j = 150 \text{ }^\circ\text{C}$	Max.	14	m $\Omega$
$I_{DRM}$ , $I_{RRM}$	$V_D = V_{DRM}$ , $V_R = V_{RRM}$	$T_j = 25 \text{ }^\circ\text{C}$	Max.	10	$\mu\text{A}$
		$T_j = 150 \text{ }^\circ\text{C}$		5	mA

**Table 4. Thermal parameters**

Symbol	Parameter	Value	Unit
$R_{th(j-c)}$	Junction to case	Max. 1.9	$^\circ\text{C/W}$
$R_{th(j-a)}$	Junction to ambient	Typ. 60	

## 1.1 Characteristics curves

**Figure 1. Maximum power dissipation versus average on-state current**

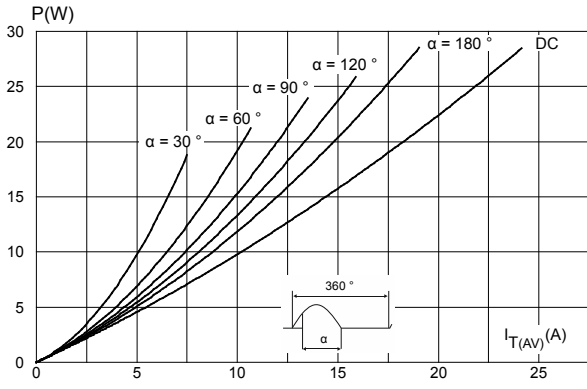

**Figure 2. Average and DC on-state current versus case temperature**

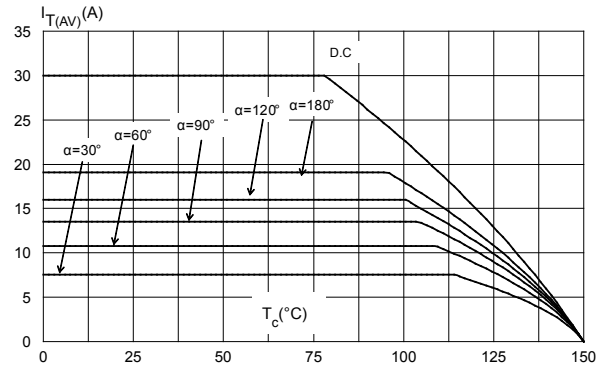

**Figure 3. Average and D.C. on state current versus ambient temperature**

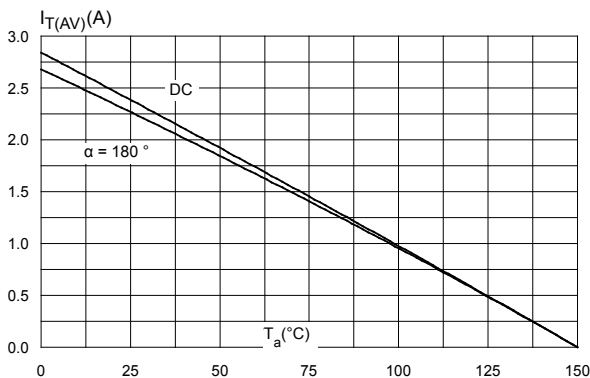

**Figure 4. On-state characteristics (maximum values)**

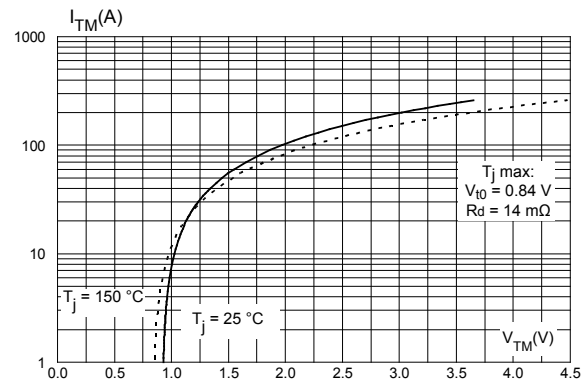

**Figure 5. Relative variation of thermal impedance junction to case and junction to ambient versus pulse duration**

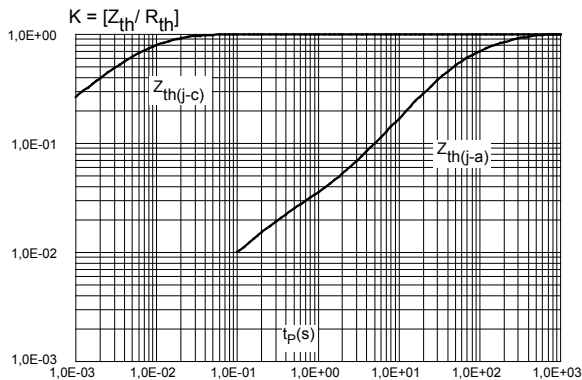

**Figure 6. Relative variation of gate trigger current and gate voltage versus junction temperature (typical values)**

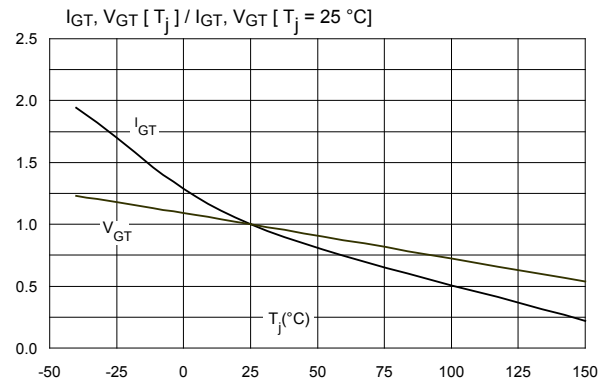

**Figure 7. Relative variation of holding and latching current versus junction temperature (typical values)**

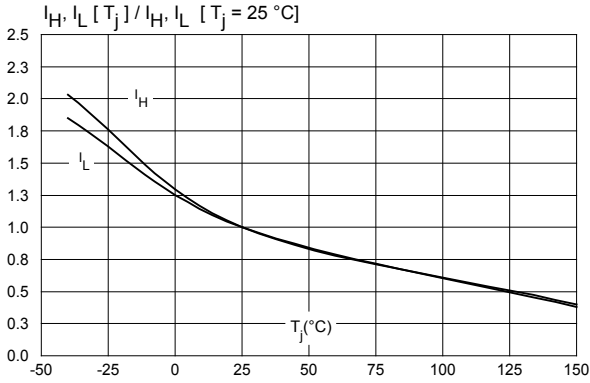

**Figure 8. Relative variation of static dV/dt immunity versus junction temperature (typical values)**

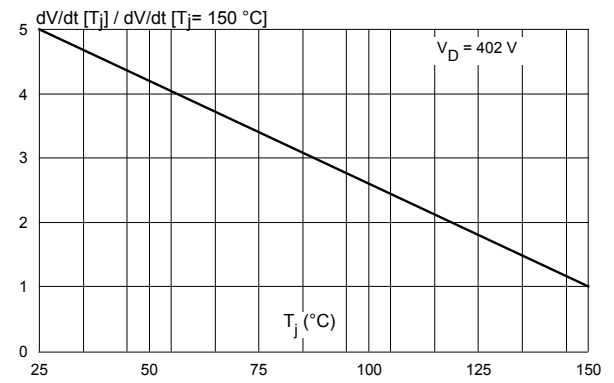

**Figure 9. Surge peak on-state current versus number of cycles**

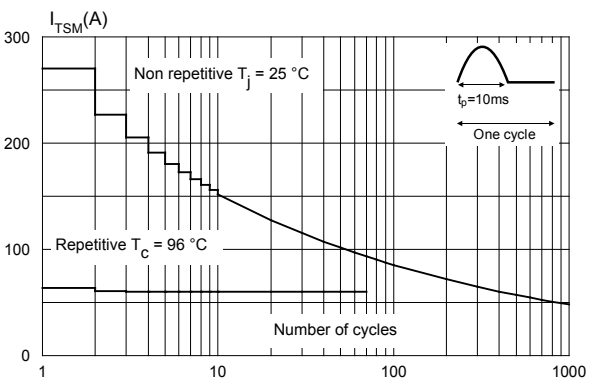

**Figure 10. Non repetitive surge peak on-state current for a sinusoidal pulse with width  $t_p < 10\text{ ms}$**

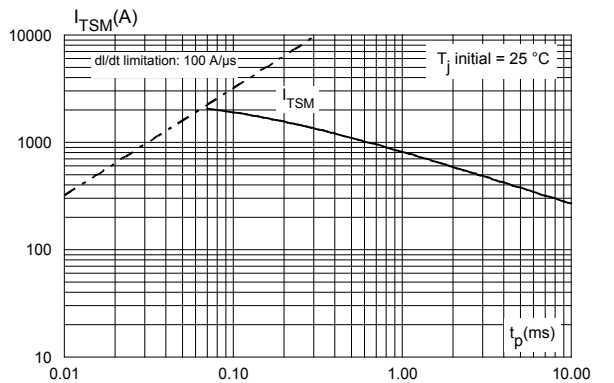

**Figure 11. Relative variation of leakage current versus junction temperature**

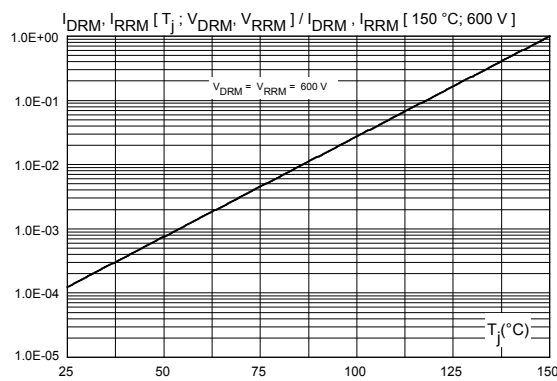

## 2 Package information

In order to meet environmental requirements, ST offers these devices in different grades of **ECOPACK** packages, depending on their level of environmental compliance. ECOPACK specifications, grade definitions and product status are available at: [www.st.com](http://www.st.com). ECOPACK is an ST trademark.

### 2.1 TO-220AB insulated package information

- Molding compound resin is halogen-free and meets flammability standard UL94 level 0
- Lead-free package leads finishing
- **ECOPACK2** compliant
- Recommended torque: 0.4 to 0.6 N.m

Figure 12. TO-220AB insulated package outline

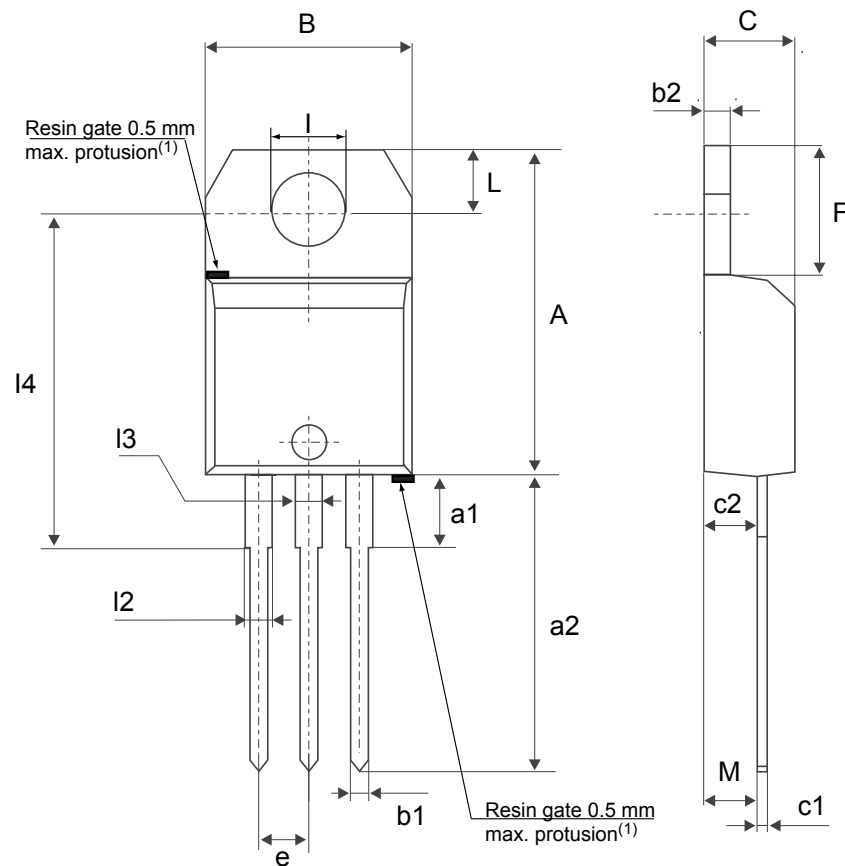

(1) Resin gate position accepted in one of the two positions or in the symmetrical opposites.

**Table 5. TO-220AB insulated package mechanical data**

Ref.	Dimensions					
	Millimeters			Inches <sup>(1)</sup>		
	Min.	Typ.	Max.	Min.	Typ.	Max.
A	15.20		15.90	0.5984		0.6260
a1		3.75			0.1476	
a2	13.00		14.00	0.5118		0.5512
B	10.00		10.40	0.3937		0.4094
b1	0.61		0.88	0.0240		0.0346
b2	1.23		1.32	0.0484		0.0520
C	4.40		4.60	0.1732		0.1811
c1	0.49		0.70	0.0193		0.0276
c2	2.40		2.72	0.0945		0.1071
e	2.40		2.70	0.0945		0.1063
F	6.20		6.60	0.2441		0.2598
l	3.73		3.88	0.1469		0.1528
L	2.65		2.95	0.1043		0.1161
l2	1.14		1.70	0.0449		0.0669
l3	1.14		1.70	0.0449		0.0669
l4	15.80	16.40	16.80	0.6220	0.6457	0.6614
M		2.6			0.1024	

1. Inch dimensions are for reference only.

### 3 Ordering information

Figure 13. Ordering information scheme

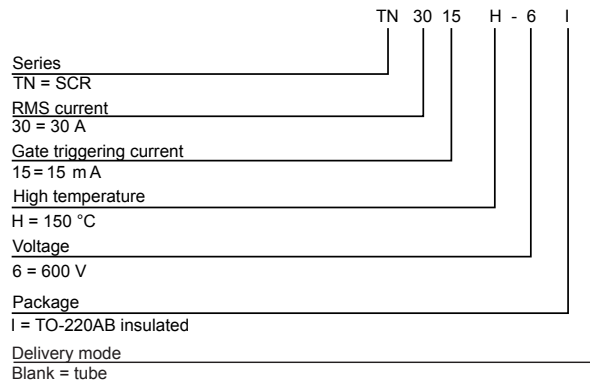

Table 6. Ordering information

Order code	Marking	Package	Weight	Base qty.	Delivery mode
TN3015H-6I	TN3015H6I	TO-220AB ins.	2.3 g	50	Tube



## Revision history

**Table 7. Document revision history**

Date	Revision	Changes
22-May-2019	1	Initial release.

**IMPORTANT NOTICE – PLEASE READ CAREFULLY**

STMicroelectronics NV and its subsidiaries (“ST”) reserve the right to make changes, corrections, enhancements, modifications, and improvements to ST products and/or to this document at any time without notice. Purchasers should obtain the latest relevant information on ST products before placing orders. ST products are sold pursuant to ST’s terms and conditions of sale in place at the time of order acknowledgement.

Purchasers are solely responsible for the choice, selection, and use of ST products and ST assumes no liability for application assistance or the design of Purchasers’ products.

No license, express or implied, to any intellectual property right is granted by ST herein.

Resale of ST products with provisions different from the information set forth herein shall void any warranty granted by ST for such product.

ST and the ST logo are trademarks of ST. For additional information about ST trademarks, please refer to [www.st.com/trademarks](http://www.st.com/trademarks). All other product or service names are the property of their respective owners.

Information in this document supersedes and replaces information previously supplied in any prior versions of this document.

© 2019 STMicroelectronics – All rights reserved