

PKU 5500S series DC-DC Converters
 Input 18 - 75 V, Output up to 15 A / 50 W

2/28701- BMR 713 Rev. D

May 2021

© Flex

Key Features

- Industry standard case dimensions
 35.3 * 25.0 * 10.4 mm (1.39 * 0.984 * 0.41 in)
- High Efficiency up to 90%
- 2250 Vdc input to output isolation
- Compliant with IEC/EN/UL 62368-1 standard

General Characteristics

- Input under voltage shutdown
- Monotonic start-up
- Remote control
- Output over voltage protection
- Over temperature protection
- Output short-circuit protection
- Output voltage adjust function
- ISO 9001/14001 certified supplier



Safety Approvals



Design for Environment



Meets requirements in high-temperature lead-free soldering processes.

Contents

Ordering Information	2
General Information	2
Safety Specification	3
Absolute Maximum Ratings	4
Electrical Specification	
3.3V, 15A / 50 W	PKU 5510S PI 5
5V, 10A / 50 W	PKU 5511S PI 8
12V, 4.2A / 50 W	PKU 5513S PI 11
15V, 3.4A / 50 W	PKU 5515S PI 14
24V, 2.1A / 50 W	PKU 5516ZS PI 17
EMC Specification	20
Operating Information	21
Thermal Consideration	22
Connections	23
Mechanical Information	24
Soldering Information	25
Delivery Information	25
Product Qualification Specification	26

Technical Specification

PKU 5500S series DC-DC Converters
Input 18 - 75 V, Output up to 15 A / 50 W

2/28701- BMR 713 Rev. D

May 2021

© Flex

Ordering Information

Product program	Output
PKU 5510S PI	3.3V, 15A / 50 W
PKU 5511S PI	5V, 10A / 50 W
PKU 5513S PI	12V, 4.2A / 50 W
PKU 5515S PI	15V, 3.4A / 50 W
PKU 5516ZS PI	24V, 2.1A / 50 W

Product number and Packaging

PKU 5XXXXX n ₁ n ₂		
Options	n ₁	n ₂
Mounting	o	
Remote Control logic		o

Options	Description
n ₁	PI Through hole
n ₂	Negative* Positive

Example: a through hole mounted product with positive logic and tray packaging would be PKU 5510S PIP.

* Standard variant (i.e. no option selected).

General Information**Reliability**

The failure rate (λ) and mean time between failures (MTBF= $1/\lambda$) is calculated at max output power and an operating ambient temperature (T_A) of +40°C. Flex uses Telcordia SR-332 Issue 3 Method 1 to calculate the mean steady-state failure rate and standard deviation (σ).

Telcordia SR-332 Issue 3 also provides techniques to estimate the upper confidence levels of failure rates based on the mean and standard deviation.

Mean steady-state failure rate, λ	Std. deviation, σ
122.224 nFailures/h	54.337 nFailures/h

MTBF (mean value) for the PKU5500S series = 8.18Mh.
MTBF at 90% confidence level = 5.12Mh

Compatibility with RoHS requirements

The products are compatible with the relevant clauses and requirements of the RoHS directive 2011/65/EU and have a maximum concentration value of 0.1% by weight in homogeneous materials for lead, mercury, hexavalent chromium, PBB and PBDE and of 0.01% by weight in homogeneous materials for cadmium.

Exemptions in the RoHS directive utilized in Flex products are found in the Statement of Compliance document.

Flex fulfills and will continuously fulfill all its obligations under regulation (EC) No 1907/2006 concerning the registration, evaluation, authorization and restriction of chemicals (REACH) as they enter into force and is through product materials declarations preparing for the obligations to communicate information on substances in the products.

Quality Statement

The products are designed and manufactured in an industrial environment where quality systems and methods like ISO 9000, Six Sigma, and SPC are intensively in use to boost the continuous improvements strategy. Infant mortality or early failures in the products are screened out and they are subjected to an ATE-based final test. Conservative design rules, design reviews and product qualifications, plus the high competence of an engaged work force, contribute to the high quality of the products.

Warranty

Warranty period and conditions are defined in Flex General Terms and Conditions of Sale.

Limitation of Liability

Flex does not make any other warranties, expressed or implied including any warranty of merchantability or fitness for a particular purpose (including, but not limited to, use in life support applications, where malfunctions of product can cause injury to a person's health or life).

© Flex 2021

The information and specifications in this technical specification is believed to be correct at the time of publication. However, no liability is accepted for inaccuracies, printing errors or for any consequences thereof. Flex reserves the right to change the contents of this technical specification at any time without prior notice.

Technical Specification

PKU 5500S series DC-DC Converters Input 18 - 75 V, Output up to 15 A / 50 W	2/28701- BMR 713 Rev. D	May 2021
	© Flex	

Safety Specification**General information**

Flex Power DC/DC converters and DC/DC regulators are designed in accordance with the safety standards IEC 62368-1, EN 62368-1 and UL 62368-1 *Audio/video, information and communication technology equipment - Part 1: Safety requirements*

IEC/EN/UL 62368-1 contains requirements to prevent injury or damage due to the following hazards:

- Electrical shock
- Electrically-caused fire
- Injury caused by hazardous substances
- Mechanically-caused injury
- Skin burn
- Radiation-caused injury

On-board DC/DC converters, Power interface modules and DC/DC regulators are defined as component power supplies. As components they cannot fully comply with the provisions of any safety requirements without "conditions of acceptability". Clearance between conductors and between conductive parts of the component power supply and conductors on the board in the final product must meet the applicable safety requirements. Certain conditions of acceptability apply for component power supplies with limited stand-off (see Mechanical Information for further information). It is the responsibility of the installer to ensure that the final product housing these components complies with the requirements of all applicable safety standards and regulations for the final product.

Component power supplies for general use shall comply with the requirements in IEC/EN/UL 62368-1. Product related standards, e.g. IEEE 802.3af *Power over Ethernet*, and ETS-300132-2 *Power interface at the input to telecom equipment, operated by direct current (dc)* are based on IEC/EN/UL 60950-1 with regards to safety.

Flex Power DC/DC converters, Power interface modules and DC/DC regulators are UL 62368-1 recognized and certified in accordance with EN 62368-1. The flammability rating for all construction parts of the products meet requirements for V-0 class material according to IEC 60695-11-10, *Fire hazard testing, test flames – 50 W* horizontal and vertical flame test methods.

Isolated DC/DC converters & Power interface modules

The product may provide basic or functional insulation between input and output according to IEC/EN/UL 62368-1 (see Safety Certificate), different conditions shall be met if the output of a basic or a functional insulated product shall be considered as ES1 energy source.

For basic insulated products (see Safety Certificate) the output is considered as ES1 energy source if one of the

following conditions is met:

- The input source provides supplementary or double or reinforced insulation from the AC mains according to IEC/EN/UL 62368-1.
- The input source provides functional or basic insulation from the AC mains and the product's output is reliably connected to protective earth according to IEC/EN/UL 62368-1.

For functional insulated products (see Safety Certificate) the output is considered as ES1 energy source if one of the following conditions is met:

- The input source provides double or reinforced insulation from the AC mains according to IEC/EN/UL 62368-1.
- The input source provides basic or supplementary insulation from the AC mains and the product's output is reliably connected to protective earth according to IEC/EN/UL 62368-1.
- The input source is reliably connected to protective earth and provides basic or supplementary insulation according to IEC/EN/UL 62368-1 and the maximum input source voltage is 60 Vdc.

Galvanic isolation between input and output is verified in an electric strength test and the isolation voltage (V_{iso}) meets the voltage strength requirement for basic insulation according to IEC/EN/UL 62368-1.

It is recommended to use a slow blow fuse at the input of each DC/DC converter. If an input filter is used in the circuit the fuse should be placed in front of the input filter. In the rare event of a component problem that imposes a short circuit on the input source, this fuse will provide the following functions:

- Isolate the fault from the input power source so as not to affect the operation of other parts of the system
- Protect the distribution wiring from excessive current and power loss thus preventing hazardous overheating

Technical Specification

PKU 5500S series DC-DC Converters
 Input 18 - 75 V, Output up to 15 A / 50 W

2/28701- BMR 713 Rev. D May 2021
 © Flex

Absolute Maximum Ratings

Characteristics		min	typ	max	Unit
T_{P1}	Operating Temperature (see Thermal Consideration section)	-40		+100	°C
T_S	Storage temperature	-55		+125	°C
V_I	Input voltage	18		75	V
V_{iso}	Isolation voltage (input to output)			2250	Vdc
V_{iso}	Isolation voltage (input to baseplate)			2250	Vdc
V_{iso}	Isolation voltage (baseplate to output)			2250	Vdc
V_{tr}	Input voltage transient (tp 1s)			100	V
V_{adj}	Adjust pin voltage (see Operating Information section)	0		V_o	V
V_{RC}	Remote Control pin voltage (see Operating Information section)	Positive logic option		6	V
		Negative logic option		6	V

Stresses above those listed under Absolute Maximum Ratings may cause permanent damage to the device. This is a stress rating only; functional operation of the device at these or any other conditions above those indicated in the Electrical Specification section of this specification is not implied. Exposure to absolute maximum rating conditions for extended periods may affect device reliability.

Fundamental Circuit Diagram

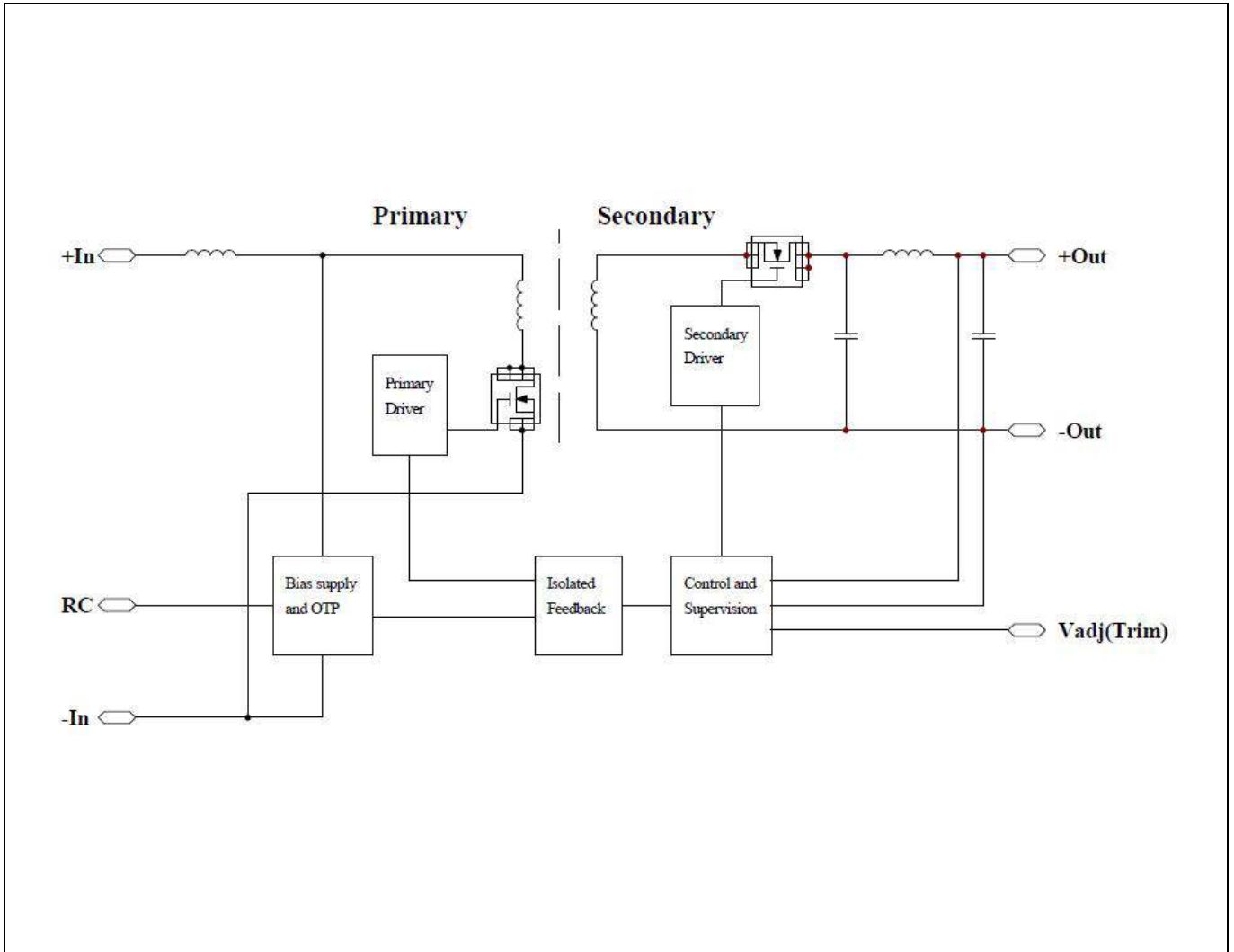

Technical Specification

PKU 5500S series DC-DC Converters
Input 18 - 75 V, Output up to 15 A / 50 W

2/28701- BMR 713 Rev. D

May 2021

© Flex

Electrical Specification

3.3 V, 15 A / 50 W

PKU 5510S PI(P)

Typical values given at: $T_{P1} = +25^{\circ}\text{C}$, $V_I = 48\text{ V}$ max I_O , unless otherwise specified under Conditions.

Additional $C_{in} = 220\ \mu\text{F}$, $C_{out} = 4.7\ \mu\text{F}$ ceramic Cap + $47\ \mu\text{F}$ tantalum Cap. See Operating Information section for selection of capacitor types.

Characteristics		Conditions	min	typ	max	Unit
V_I	Input voltage range		18		75	V
V_{loff}	Turn-off input voltage	Decreasing input voltage	13.5	14.3	14.5	V
V_{lon}	Turn-on input voltage	Increasing input voltage	14.8	15.5	18.0	V
C_I	Internal input capacitance			2.2		μF
P_O	Output power	$V_I = 18\text{-}36\text{ V}$	0		40	W
		$V_I = 36\text{-}75\text{ V}$	0		50	W
η	Efficiency	50% of max I_O , $V_I = 24\text{ V}$		89		%
		max I_O , $V_I = 24\text{ V}$		89		
		50% of max I_O , $V_I = 48\text{ V}$		88		
		max I_O , $V_I = 48\text{ V}$		90		
P_d	Power Dissipation	max I_O		5		W
P_{ii}	Input idling power	$I_O = 0\text{ A}$, $V_I = 48\text{ V}$		2.5		W
P_{RC}	Input standby power	$V_I = 48\text{ V}$ (turned off with RC)		0.4		W
f_s	Switching frequency	0-100 % of max I_O	374	440	506	kHz

V_{Oi}	Output voltage initial setting and accuracy	$T_{P1} = +25^{\circ}\text{C}$, $V_I = 48\text{ V}$, $I_O = 15\text{ A}$	3.267	3.3	3.333	V
V_O	Output adjust range	See operating information	2.97	3.3	3.63	V
	Output voltage tolerance band	0-100% of max I_O	2.267		3.333	V
	Idling voltage	$I_O = 0\text{ A}$	2.267		3.333	V
	Line regulation	max I_O		15	33	mV
	Load regulation	$V_I = 48\text{ V}$, 25-100% of max I_O		33	66	mV
V_{tr}	Load transient voltage deviation	$V_I = 48\text{ V}$, Load step 50-75-50% of max I_O , $di/dt = 100\text{mA}/\mu\text{s}$		± 120		mV
t_{tr}	Load transient recovery time			300	500	μs
t_r	Ramp-up time (from 10-90% of V_{Oi})	10-100% of max I_O , $T_{P1} = 25^{\circ}\text{C}$, $V_I = 48\text{ V}$		1		ms
t_s	Start-up time (from V_I connection to 90% of V_{Oi})			2.5		ms
t_{RC}	RC start-up time (from V_{RC} connection to 90% of V_{Oi})		max I_O		1	
RC	Sink current, see Note 1	See operating information	0.5			mA
	Trigger level	Decreasing / Increasing RC-voltage		0.8/2.5		V
I_O	Output current	$V_I = 18\text{-}36\text{ V}$	0		12	A
		$V_I = 36\text{-}75\text{ V}$	0		15	A
I_{lim}	Current limit threshold	$V_I = 48\text{ V}$, $T_{P1} < \text{max } T_{P1}$		22.5	30	A
I_{sc}	Short circuit current	$T_{P1} = 25^{\circ}\text{C}$, see Note 2		0.509		A
C_{out}	Recommended Capacitive Load	$T_{P1} = 25^{\circ}\text{C}$	0		10000	μF
V_{Oac}	Output ripple & noise	See ripple & noise section, V_{Oi} , max I_O , see Note 3		80	100	mVp-p
OVP	Over voltage protection	$T_{P1} = +25^{\circ}\text{C}$, $V_I = 48\text{ V}$, 0-100% of max I_O		4.3		V

Note 1: Sink current drawn by external device connected to the RC pin.

Note 2: Hiccup mode, RMS value, see Operating Information section.

Note 3: Measured with $4.7\ \mu\text{F}$ ceramic Cap. and $47\ \mu\text{F}$ tantalum Cap. cross to output.

PKU 5500S series DC-DC Converters
Input 18 - 75 V, Output up to 15 A / 50 W

2/28701- BMR 713 Rev. D

May 2021

© Flex

Typical Characteristics
3.3 V, 15 A / 50 W

PKU 5510S PI(P)

Efficiency

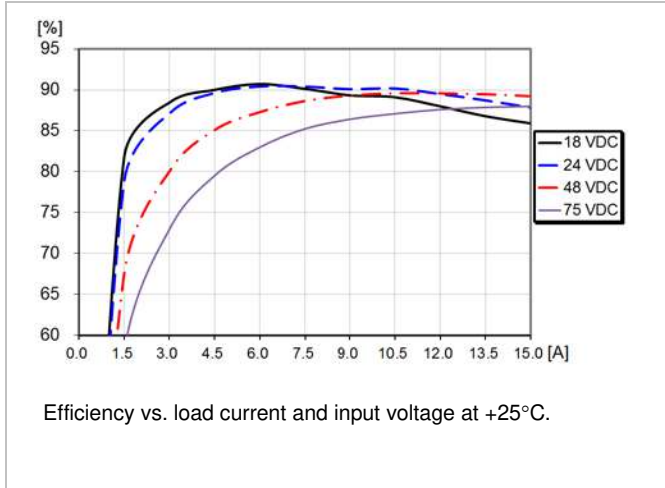

Power Dissipation

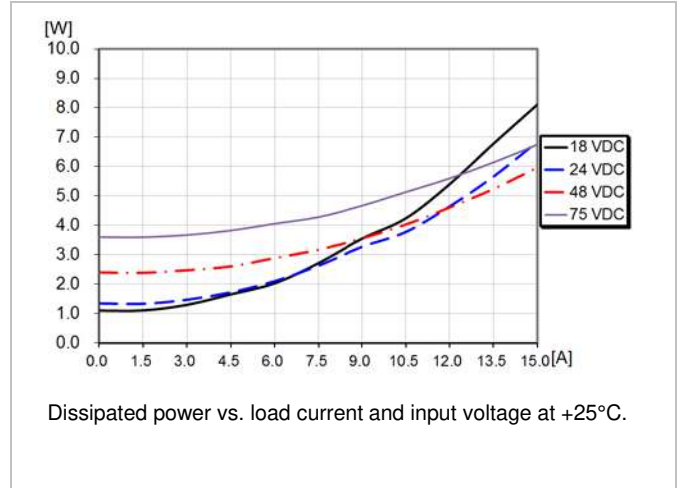

Output Current Derating

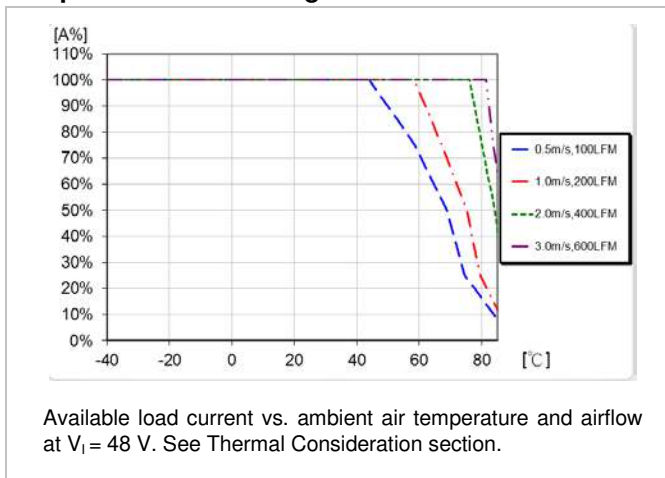

Current Limit Characteristics

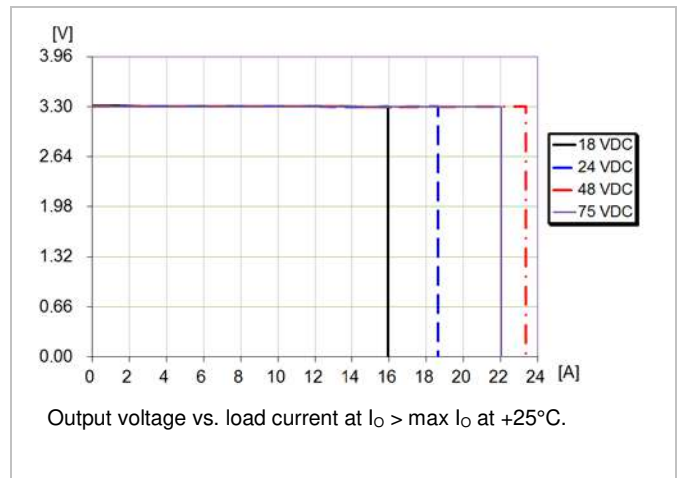

Output Characteristics

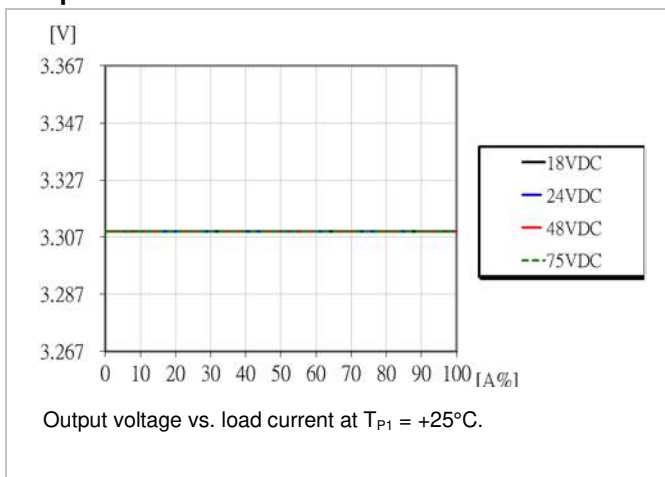

PKU 5500S series DC-DC Converters
Input 18 - 75 V, Output up to 15 A / 50 W

2/28701- BMR 713 Rev. D

May 2021

© Flex

Typical Characteristics
3.3 V, 15 A / 50 W

PKU 5510S PI(P)

Start-up

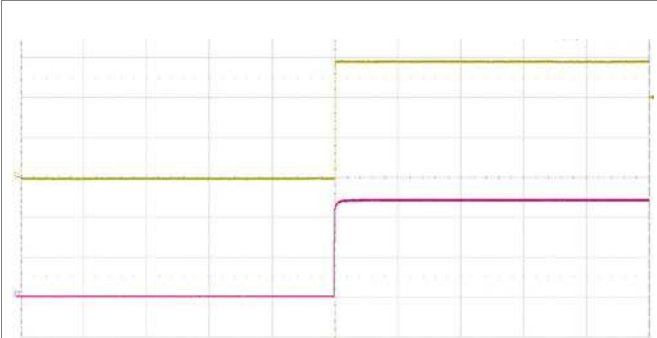

Start-up enabled by connecting V_I at:
 $T_{P1} = +25^{\circ}\text{C}$, $V_I = 48\text{ V}$,
 $I_o = 15\text{ A}$ resistive load.
Top trace: output voltage (1 V/div.).
Bottom trace: input voltage (20 V/div.).
Time scale: (200 ms/div.).

Shut-down

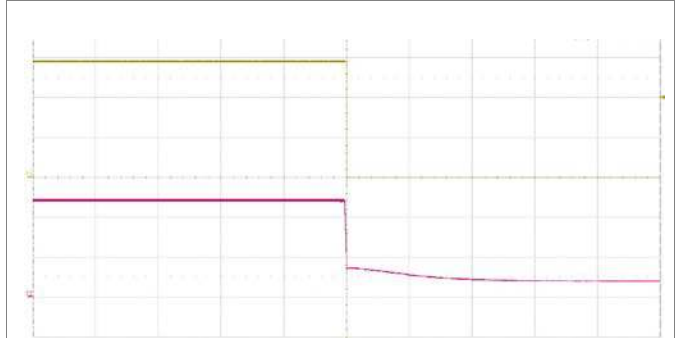

Start-up enabled by connecting V_I at:
 $T_{P1} = +25^{\circ}\text{C}$, $V_I = 48\text{ V}$,
 $I_o = 15\text{ A}$ resistive load.
Top trace: output voltage (1 V/div.).
Bottom trace: input voltage (20 V/div.).
Time scale: (200 ms/div.).

Output Ripple & Noise

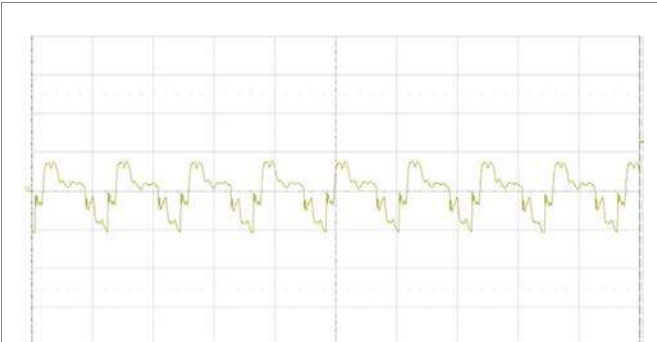

Output voltage ripple at:
 $T_{P1} = +25^{\circ}\text{C}$, $V_I = 48\text{ V}$,
 $I_o = 15\text{ A}$ resistive load.
Trace: output voltage (20 mV/div.).
Time scale: (2 μs /div.).
20 MHz bandwidth.

Output Load Transient Response

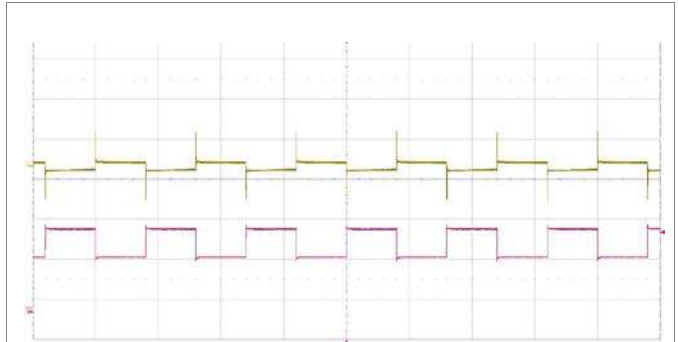

Output voltage response to load current step-
change (7.5-11.25-7.5 A) at:
 $T_{P1} = +25^{\circ}\text{C}$, $V_I = 48\text{ V}$.
Top trace: output voltage (500 mV/div.).
Bottom trace: load current (5 A/div.).
Time scale: (10 ms/div.).

Output Voltage Adjust (TRIM UP/TRIM DOWN)

Output Voltage = 3.3 V

The resistor value for an adjusted output voltage is calculated by using the following equations:

Output Voltage Adjust, Increase:

$$R_{ADJ_UP} = \left(\frac{0.189}{\Delta} - 1.69 \right) k\Omega$$

Output Voltage Adjust, Decrease:

$$R_{ADJ_DOWN} = \left(\frac{0.3098}{\Delta} - 2.189 \right) k\Omega$$

Example:

To trim up the 3.3 V model by 8% to 3.56 V the required external resistor is:

$$R_{ADJ_UP} = \left(\frac{0.189}{0.08} - 1.69 \right) = 0.6725k\Omega$$

Example:

To trim down the 3.3 V model by 7% to 3.07 V the required external resistor is:

$$R_{ADJ_DOWN} = \left(\frac{0.3098}{0.07} - 2.189 \right) = 2.2367k\Omega$$

Technical Specification

PKU 5500S series DC-DC Converters
Input 18 - 75 V, Output up to 15 A / 50 W

2/28701- BMR 713 Rev. D

May 2021

© Flex

Electrical Specification

5 V, 10 A / 50 W

PKU 5511S PI(P)

Typical values given at: $T_{P1} = +25^{\circ}\text{C}$, $V_I = 48\text{ V}$ max I_O , unless otherwise specified under Conditions.

Additional $C_{in} = 220\ \mu\text{F}$, $C_{out} = 4.7\ \mu\text{F}$ ceramic Cap + $47\ \mu\text{F}$ tantalum Cap. See Operating Information section for selection of capacitor types.

Characteristics		Conditions	min	typ	max	Unit
V_I	Input voltage range		18		75	V
V_{loff}	Turn-off input voltage	Decreasing input voltage	13.5	14.3	14.5	V
V_{lon}	Turn-on input voltage	Increasing input voltage	14.8	15.5	18.0	V
C_I	Internal input capacitance			2.2		μF
P_O	Output power	$V_I = 18\text{-}36\text{ V}$	0		40	W
		$V_I = 36\text{-}75\text{ V}$	0		50	W
η	Efficiency	50% of max I_O , $V_I = 24\text{ V}$		90		%
		max I_O , $V_I = 24\text{ V}$		89		
		50% of max I_O , $V_I = 48\text{ V}$		89		
		max I_O , $V_I = 48\text{ V}$		90		
P_d	Power Dissipation	max I_O		5		W
P_{ii}	Input idling power	$I_O = 0\text{ A}$, $V_I = 48\text{ V}$		2.35		W
P_{RC}	Input standby power	$V_I = 48\text{ V}$ (turned off with RC)		0.4		W
f_s	Switching frequency	0-100 % of max I_O	374	440	506	kHz

V_{Oi}	Output voltage initial setting and accuracy	$T_{P1} = +25^{\circ}\text{C}$, $V_I = 48\text{ V}$, $I_O = 10\text{ A}$	4.95	5	5.05	V
V_O	Output adjust range	See operating information	4.5	5	5.5	V
	Output voltage tolerance band	0-100% of max I_O	4.95		5.05	V
	Idling voltage	$I_O = 0\text{ A}$	4.95		5.05	V
	Line regulation	max I_O		25	50	mV
	Load regulation	$V_I = 48\text{ V}$, 25-100% of max I_O		50	100	mV
V_{tr}	Load transient voltage deviation	$V_I = 48\text{ V}$, Load step 50-75-50% of max I_O , $di/dt = 100\text{mA}/\mu\text{s}$		± 110		mV
t_{tr}	Load transient recovery time			300	500	μs
t_r	Ramp-up time (from 10-90% of V_{Oi})	10-100% of max I_O		3		ms
t_s	Start-up time (from V_I connection to 90% of V_{Oi})			5		ms
t_{RC}	RC start-up time (from V_{RC} connection to 90% of V_{Oi})		max I_O		3	
RC	Sink current, see Note 1	See operating information	0.5			mA
	Trigger level	Decreasing / Increasing RC-voltage		0.8/2.5		V
I_O	Output current	$V_I = 18\text{-}36\text{ V}$	0		8	A
		$V_I = 36\text{-}75\text{ V}$	0		10	A
I_{lim}	Current limit threshold	$V_I = 48\text{ V}$, $T_{P1} < \text{max } T_{P1}$		15	20	A
I_{sc}	Short circuit current	$T_{P1} = 25^{\circ}\text{C}$, see Note 2		0.452		A
C_{out}	Recommended Capacitive Load	$T_{P1} = 25^{\circ}\text{C}$	0		5000	μF
V_{Oac}	Output ripple & noise	See ripple & noise section, V_{Oi} , max I_O , see Note 3		80	100	mVp-p
OVP	Over voltage protection	$T_{P1} = +25^{\circ}\text{C}$, $V_I = 48\text{ V}$, 0-100% of max I_O		6.3		V

Note 1: Sink current drawn by external device connected to the RC pin.

Note 2: Hiccup mode, RMS value, see Operating Information section.

Note 3: Measured with $4.7\ \mu\text{F}$ ceramic Cap. and $47\ \mu\text{F}$ tantalum Cap. cross to output.

PKU 5500S series DC-DC Converters
Input 18 - 75 V, Output up to 15 A / 50 W

2/28701- BMR 713 Rev. D

May 2021

© Flex

Typical Characteristics 5 V, 10 A / 50 W

PKU 5511S PI(P)

Efficiency

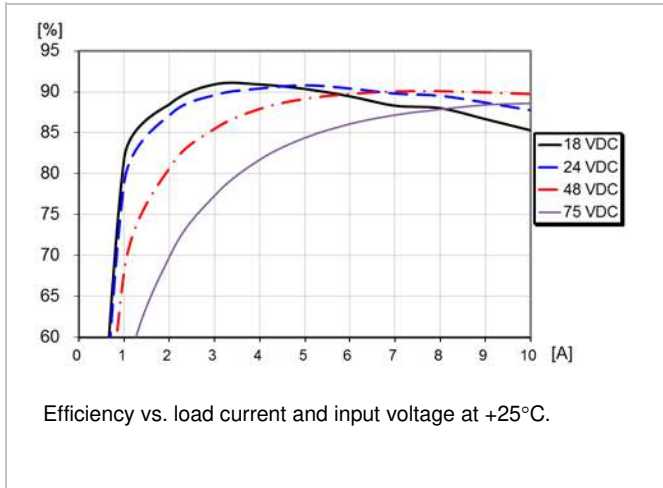

Power Dissipation

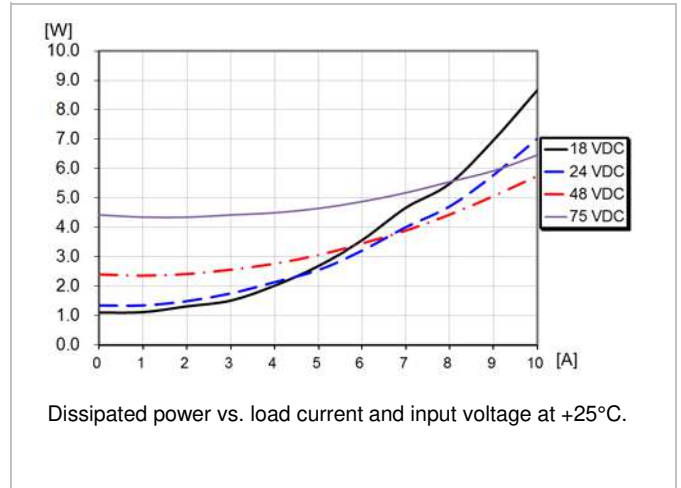

Output Current Derating

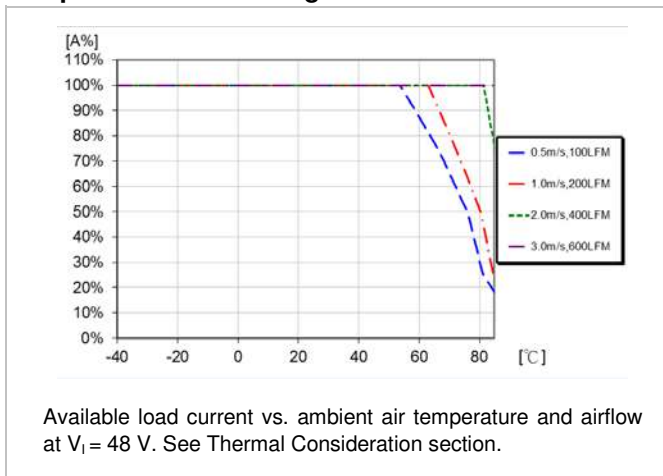

Current Limit Characteristics

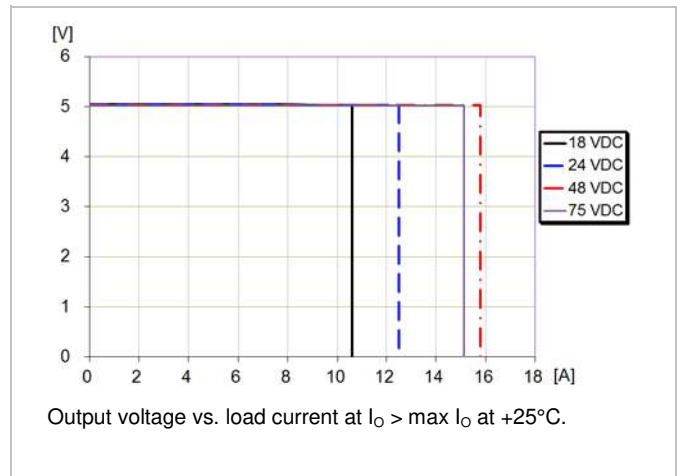

Output Characteristics

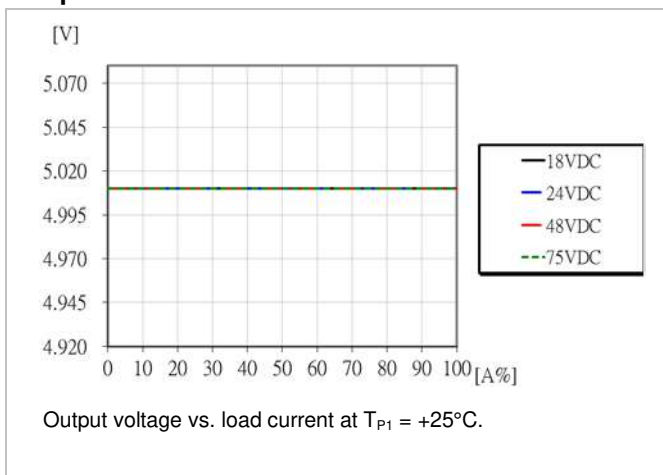

PKU 5500S series DC-DC Converters
Input 18 - 75 V, Output up to 15 A / 50 W

2/28701- BMR 713 Rev. D

May 2021

© Flex

Typical Characteristics
5 V, 10 A / 50 W

PKU 5511S PI(P)

Start-up

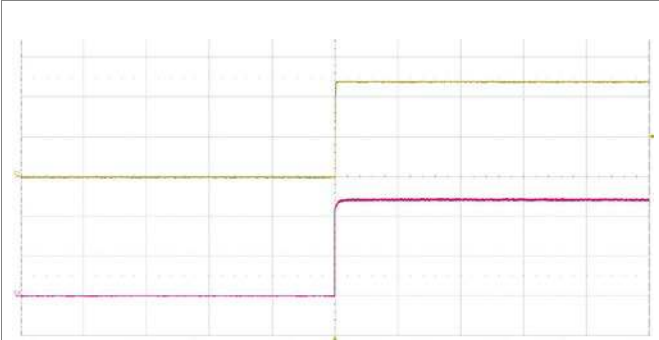

Start-up enabled by connecting V_I at:
 $T_{P1} = +25^{\circ}\text{C}$, $V_I = 48\text{ V}$,
 $I_O = 10\text{ A}$ resistive load.
Top trace: output voltage (2 V/div.).
Bottom trace: input voltage (20 V/div.).
Time scale: (200 ms/div.).

Shut-down

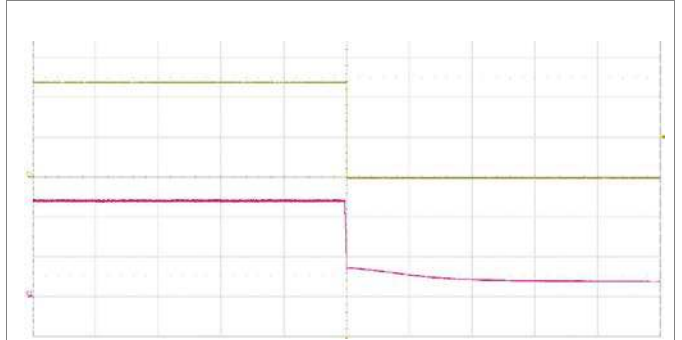

Start-up enabled by connecting V_I at:
 $T_{P1} = +25^{\circ}\text{C}$, $V_I = 48\text{ V}$,
 $I_O = 10\text{ A}$ resistive load.
Top trace: output voltage (2 V/div.).
Bottom trace: input voltage (20 V/div.).
Time scale: (200 ms/div.).

Output Ripple & Noise

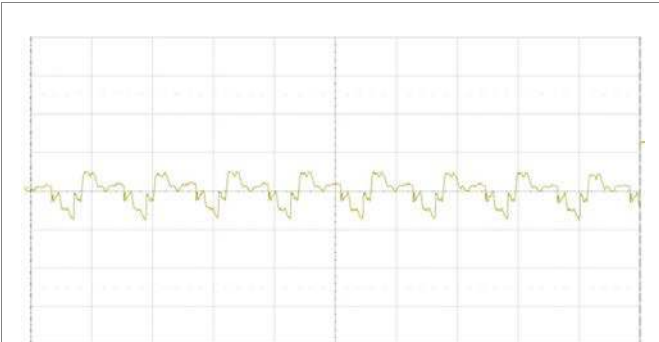

Output voltage ripple at:
 $T_{P1} = +25^{\circ}\text{C}$, $V_I = 48\text{ V}$,
 $I_O = 10\text{ A}$ resistive load.
Trace: output voltage (20 mV/div.).
Time scale: (2 μs/div.).
20 MHz bandwidth.

Output Load Transient Response

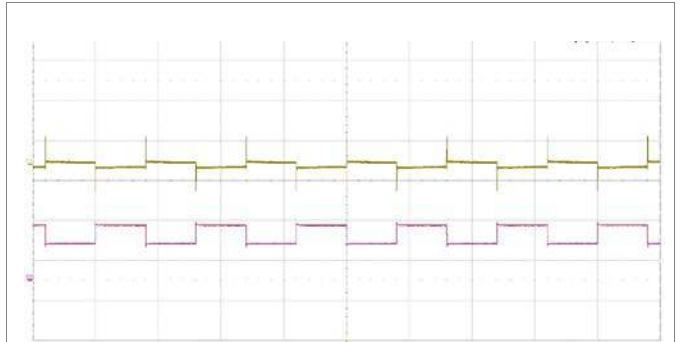

Output voltage response to load current step-
change (5.0-7.5-5.0 A) at:
 $T_{P1} = +25^{\circ}\text{C}$, $V_I = 48\text{ V}$.
Top trace: output voltage (500 mV/div.).
Bottom trace: load current (5 A/div.).
Time scale: (10 ms/div.).

Output Voltage Adjust (TRIM UP/TRIM DOWN)

Output Voltage = 5 V

The resistor value for an adjusted output voltage is calculated by using the following equations:

Output Voltage Adjust, Increase:

$$R_{ADJ_UP} = \left(\frac{0.2}{\Delta} - 1.5 \right) k\Omega$$

Output Voltage Adjust, Decrease:

$$R_{ADJ_DOWN} = \left(\frac{0.269}{\Delta} - 1.97 \right) k\Omega$$

Example:

To trim up the 5 V model by 8% to 5.4 V the required external resistor is:

$$R_{ADJ_UP} = \left(\frac{0.2}{0.08} - 1.5 \right) = 1k\Omega$$

Example:

To trim down the 5 V model by 7% to 4.65 V the required external resistor is:

$$R_{ADJ_DOWN} = \left(\frac{0.269}{0.07} - 1.97 \right) = 1.873k\Omega$$

Technical Specification

PKU 5500S series DC-DC Converters
Input 18 - 75 V, Output up to 15 A / 50 W

2/28701- BMR 713 Rev. D

May 2021

© Flex

Electrical Specification

12 V, 4.2 A / 50 W

PKU 5513S PI(P)

Typical values given at: $T_{P1} = +25^{\circ}\text{C}$, $V_I = 48\text{ V}$ max I_O , unless otherwise specified under Conditions.

Additional $C_{in} = 220\ \mu\text{F}$, $C_{out} = 4.7\ \mu\text{F}$ ceramic Cap + $47\ \mu\text{F}$ tantalum Cap. See Operating Information section for selection of capacitor types.

Characteristics		Conditions	min	typ	max	Unit
V_I	Input voltage range		18		75	V
V_{loff}	Turn-off input voltage	Decreasing input voltage	13.5	14.3	14.5	V
V_{lon}	Turn-on input voltage	Increasing input voltage	14.8	15.5	18.0	V
C_I	Internal input capacitance			2.2		μF
P_O	Output power	$V_I = 18\text{-}36\text{ V}$	0		40	W
		$V_I = 36\text{-}75\text{ V}$	0		50	W
η	Efficiency	50% of max I_O , $V_I = 24\text{ V}$		88		%
		max I_O , $V_I = 24\text{ V}$		88		
		50% of max I_O , $V_I = 48\text{ V}$		88		
		max I_O , $V_I = 48\text{ V}$		90		
P_d	Power Dissipation	max I_O		5		W
P_{ii}	Input idling power	$I_O = 0\text{ A}$, $V_I = 48\text{ V}$		0.5		W
P_{RC}	Input standby power	$V_I = 48\text{ V}$ (turned off with RC)		0.4		W
f_s	Switching frequency	0-100 % of max I_O	374	440	506	kHz

V_{O_i}	Output voltage initial setting and accuracy	$T_{P1} = +25^{\circ}\text{C}$, $V_I = 48\text{ V}$, $I_O = 4.2\text{ A}$	11.88	12	12.12	V
V_O	Output adjust range	See operating information	10.8	12	13.2	V
	Output voltage tolerance band	0-100% of max I_O	11.88		12.12	V
	Idling voltage	$I_O = 0\text{ A}$	11.88		12.12	V
	Line regulation	max I_O		60	120	mV
	Load regulation	$V_I = 48\text{ V}$, 25-100% of max I_O		120	240	mV
V_{tr}	Load transient voltage deviation	$V_I = 48\text{ V}$, Load step 50-75-50% of max I_O , $di/dt = 100\text{ mA}/\mu\text{s}$		± 310		mV
t_{tr}	Load transient recovery time			300	500	μs
t_r	Ramp-up time (from 10-90% of V_{O_i})	10-100% of max I_O		10		ms
t_s	Start-up time (from V_I connection to 90% of V_{O_i})			12		ms
t_{RC}	RC start-up time (from V_{RC} connection to 90% of V_{O_i})	max I_O		10		ms
RC	Sink current, see Note 1	See operating information	0.5			mA
	Trigger level	Decreasing / Increasing RC-voltage		0.8/2.5		V
I_O	Output current	$V_I = 18\text{-}36\text{ V}$	0		3.5	A
		$V_I = 36\text{-}75\text{ V}$	0		4.2	A
I_{lim}	Current limit threshold	$V_I = 48\text{ V}$, $T_{P1} < \text{max } T_{P1}$		6.3	8.4	A
I_{sc}	Short circuit current	$T_{P1} = 25^{\circ}\text{C}$, see Note 2		0.456		A
C_{out}	Recommended Capacitive Load	$T_{P1} = 25^{\circ}\text{C}$	0		2200	μF
V_{Oac}	Output ripple & noise	See ripple & noise section, V_{O_i} , max I_O , see Note 3		80	100	mVp-p
OVP	Over voltage protection	$T_{P1} = +25^{\circ}\text{C}$, $V_I = 48\text{ V}$, 0-100% of max I_O		15		V

Note 1: Sink current drawn by external device connected to the RC pin.

Note 2: Hiccup mode, RMS value, see Operating Information section.

Note 3: Measured with $4.7\ \mu\text{F}$ ceramic Cap. and $47\ \mu\text{F}$ tantalum Cap. cross to output.

Technical Specification

PKU 5500S series DC-DC Converters
Input 18 - 75 V, Output up to 15 A / 50 W

2/28701- BMR 713 Rev. D

May 2021

© Flex

Typical Characteristics
12 V, 4.2 A / 50 W

PKU 5513S PI(P)

Efficiency

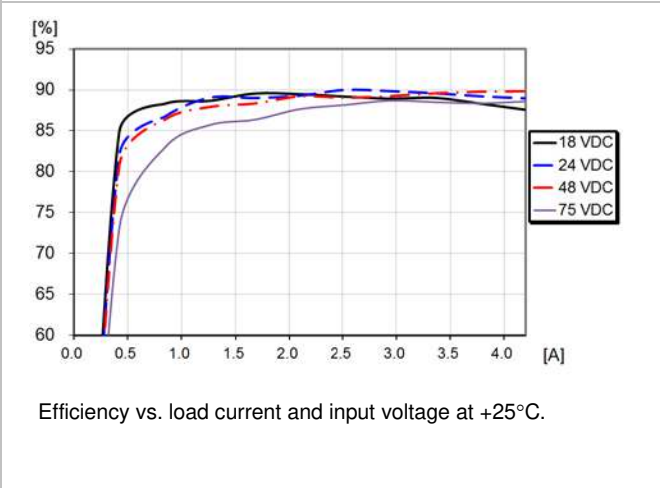

Power Dissipation

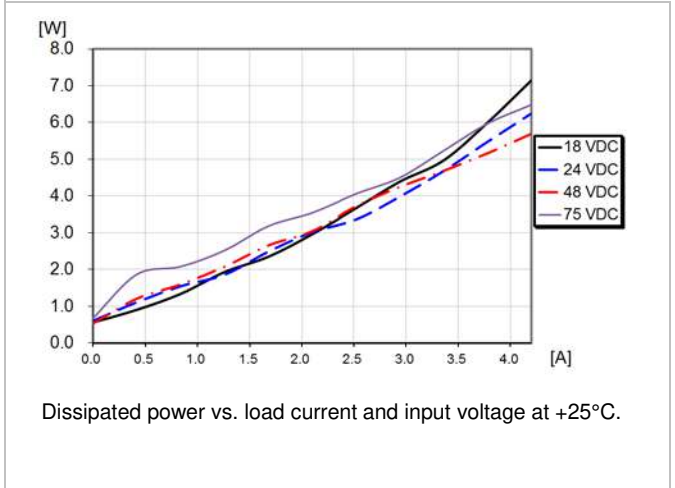

Output Current Derating

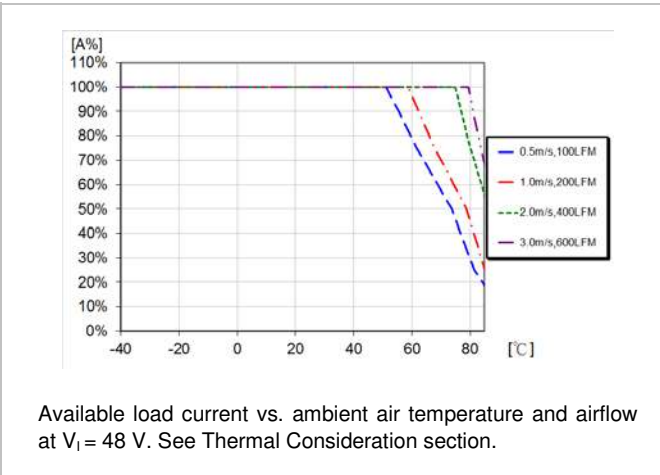

Current Limit Characteristics

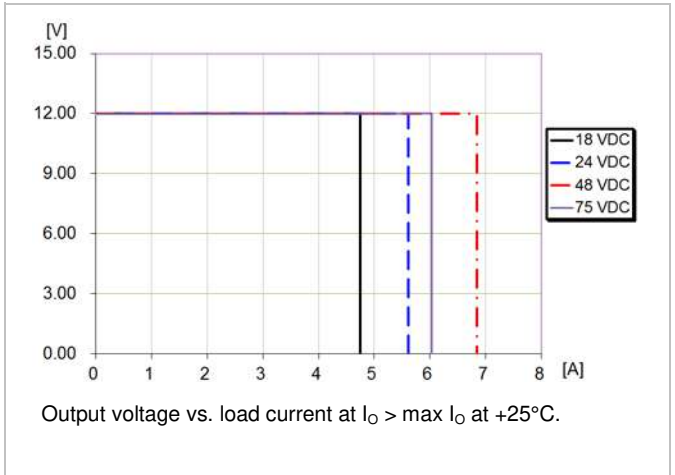

Output Characteristics

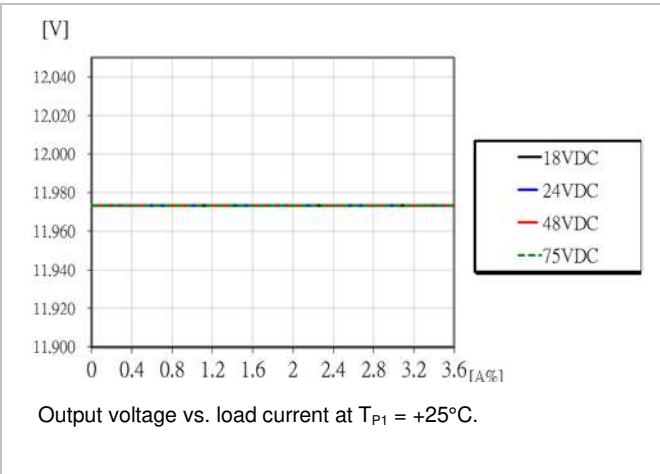

PKU 5500S series DC-DC Converters
Input 18 - 75 V, Output up to 15 A / 50 W

2/28701-BMR 713 Rev. D

May 2021

© Flex

Typical Characteristics
12 V, 4.2 A / 50 W

PKU 5513S PI(P)

Start-up

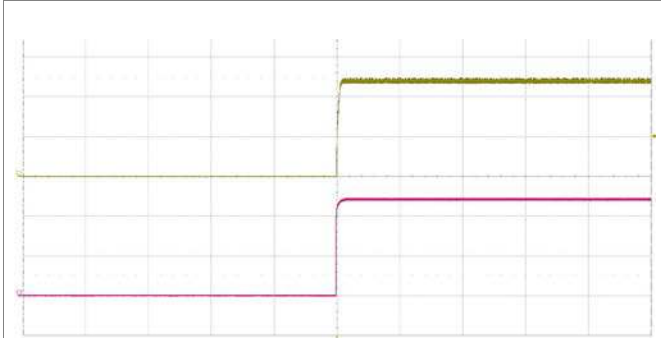

Start-up enabled by connecting V_I at:
 $T_{P1} = +25^{\circ}\text{C}$, $V_I = 48\text{ V}$,
 $I_o = 4.2\text{ A}$ resistive load.

Top trace: output voltage (5 V/div.).
Bottom trace: input voltage (20 V/div.).
Time scale: (200 ms/div.).

Shut-down

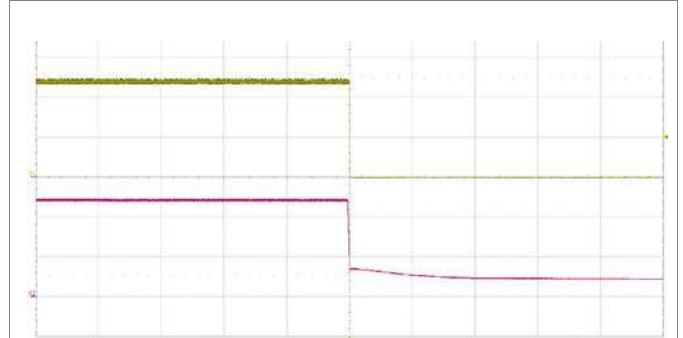

Start-up enabled by connecting V_I at:
 $T_{P1} = +25^{\circ}\text{C}$, $V_I = 48\text{ V}$,
 $I_o = 4.2\text{ A}$ resistive load.

Top trace: output voltage (5 V/div.).
Bottom trace: input voltage (20 V/div.).
Time scale: (200 ms/div.).

Output Ripple & Noise

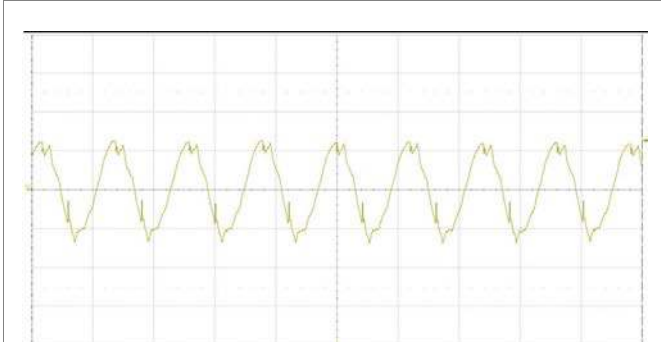

Output voltage ripple at:
 $T_{P1} = +25^{\circ}\text{C}$, $V_I = 48\text{ V}$,
 $I_o = 4.2\text{ A}$ resistive load.

Trace: output voltage (20 mV/div.).
Time scale: (2 μs /div.).
20 MHz bandwidth.

Output Load Transient Response

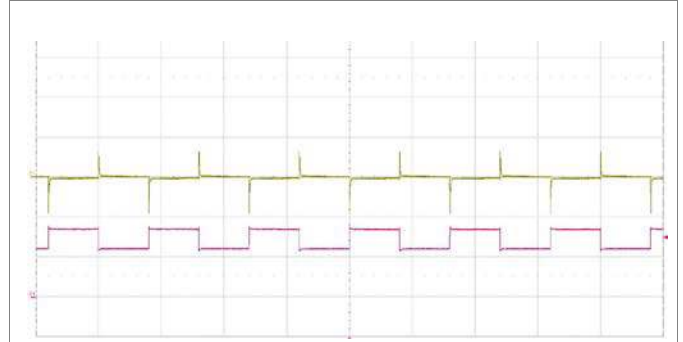

Output voltage response to load current step-change (2.1-3.15-2.1 A) at:
 $T_{P1} = +25^{\circ}\text{C}$, $V_I = 48\text{ V}$.

Top trace: output voltage (500 mV/div.).
Bottom trace: load current (2 A/div.).
Time scale: (10 ms/div.).

Output Voltage Adjust (TRIM UP/TRIM DOWN)

Output Voltage = 12 V

The resistor value for an adjusted output voltage is calculated by using the following equations:

Output Voltage Adjust, Increase:

$$R_{ADJ_UP} = \left(\frac{0.9455}{\Delta} - 7.5 \right) k\Omega$$

Output Voltage Adjust, Decrease:

$$R_{ADJ_DOWN} = \left(\frac{1.196}{\Delta} - 3.643 \right) k\Omega$$

Example:

To trim up the 12 V model by 8% to 12.96 V the required external resistor is:

$$R_{ADJ_UP} = \left(\frac{0.9455}{0.08} - 7.5 \right) = 1k\Omega$$

Example:

To trim down the 12 V model by 7% to 11.16 V the required external resistor is:

$$R_{ADJ_DOWN} = \left(\frac{1.196}{0.07} - 3.643 \right) = 13.443k\Omega$$

Technical Specification

PKU 5500S series DC-DC Converters
Input 18 - 75 V, Output up to 15 A / 50 W

2/28701- BMR 713 Rev. D

May 2021

© Flex

Electrical Specification

15 V, 3.4 A / 50 W

PKU 5515S PI(P)

Typical values given at: $T_{P1} = +25^{\circ}\text{C}$, $V_I = 48\text{ V}$ max I_O , unless otherwise specified under Conditions.

Additional $C_{in} = 220\ \mu\text{F}$, $C_{out} = 4.7\ \mu\text{F}$ ceramic Cap + $47\ \mu\text{F}$ tantalum Cap. See Operating Information section for selection of capacitor types.

Characteristics		Conditions	min	typ	max	Unit
V_I	Input voltage range		18		75	V
V_{loff}	Turn-off input voltage	Decreasing input voltage	13.5	14.3	14.5	V
V_{lon}	Turn-on input voltage	Increasing input voltage	14.8	15.5	18.0	V
C_I	Internal input capacitance			2.2		μF
P_O	Output power	$V_I = 18\text{-}36\text{ V}$	0		40	W
		$V_I = 36\text{-}75\text{ V}$	0		50	W
η	Efficiency	50% of max I_O , $V_I = 24\text{ V}$		89		%
		max I_O , $V_I = 24\text{ V}$		88		
		50% of max I_O , $V_I = 48\text{ V}$		89		
		max I_O , $V_I = 48\text{ V}$		90		
P_d	Power Dissipation	max I_O		5		W
P_{ii}	Input idling power	$I_O = 0\text{ A}$, $V_I = 48\text{ V}$		0.4		W
P_{RC}	Input standby power	$V_I = 48\text{ V}$ (turned off with RC)		0.4		W
f_s	Switching frequency	0-100 % of max I_O	374	440	506	kHz

V_{O_i}	Output voltage initial setting and accuracy	$T_{P1} = +25^{\circ}\text{C}$, $V_I = 48\text{ V}$, $I_O = 3.4\text{ A}$	14.85	15	15.15	V
V_O	Output adjust range	See operating information	13.5	15	16.5	V
	Output voltage tolerance band	0-100% of max I_O	14.85		15.15	V
	Idling voltage	$I_O = 0\text{ A}$	14.85		15.15	V
	Line regulation	max I_O		75	150	mV
	Load regulation	$V_I = 48\text{ V}$, 25-100% of max I_O		150	300	mV
V_{tr}	Load transient voltage deviation	$V_I = 48\text{ V}$, Load step 50-75-50% of max I_O , $di/dt = 100\text{mA}/\mu\text{s}$		± 230		mV
t_{tr}	Load transient recovery time			300	500	μs
t_r	Ramp-up time (from 10-90% of V_{O_i})	10-100% of max I_O		13		ms
t_s	Start-up time (from V_I connection to 90% of V_{O_i})			15		ms
t_{RC}	RC start-up time (from V_{RC} connection to 90% of V_{O_i})		max I_O		11	
RC	Sink current, see Note 1	See operating information	0.5			mA
	Trigger level	Decreasing / Increasing RC-voltage		0.8/2.5		V
I_O	Output current	$V_I = 18\text{-}36\text{ V}$	0		2.8	A
		$V_I = 36\text{-}75\text{ V}$	0		3.4	A
I_{lim}	Current limit threshold	$V_I = 48\text{ V}$, $T_{P1} < \text{max } T_{P1}$		5.1	6.8	A
I_{sc}	Short circuit current	$T_{P1} = 25^{\circ}\text{C}$, see Note 2		0.447		A
C_{out}	Recommended Capacitive Load	$T_{P1} = 25^{\circ}\text{C}$	0		1000	μF
V_{Oac}	Output ripple & noise	See ripple & noise section, V_{O_i} , max I_O , see Note 3		80	100	mVp-p
OVP	Over voltage protection	$T_{P1} = +25^{\circ}\text{C}$, $V_I = 48\text{ V}$, 0-100% of max I_O		17		V

Note 1: Sink current drawn by external device connected to the RC pin.

Note 2: Hiccup mode, RMS value, see Operating Information section.

Note 3: Measured with $4.7\ \mu\text{F}$ ceramic Cap. and $47\ \mu\text{F}$ tantalum Cap. cross to output.

PKU 5500S series DC-DC Converters
Input 18 - 75 V, Output up to 15 A / 50 W

2/28701- BMR 713 Rev. D

May 2021

© Flex

Typical Characteristics
15 V, 3.4 A / 50 W

PKU 5515S PI(P)

Efficiency

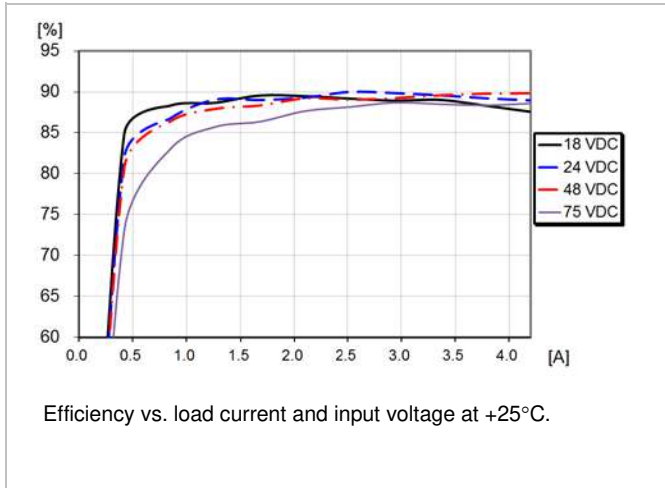

Power Dissipation

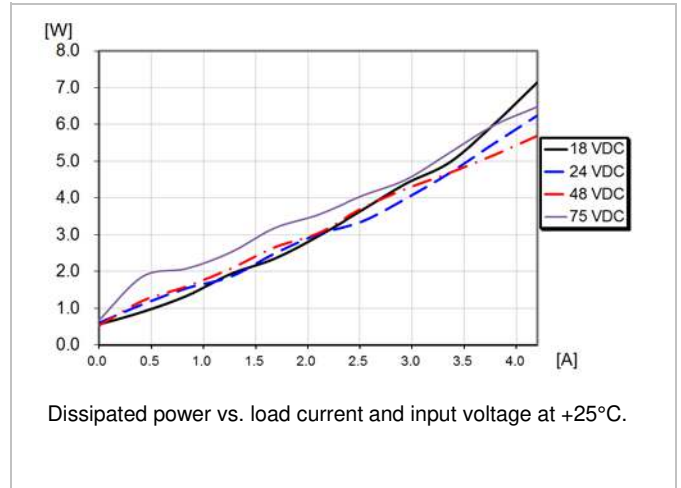

Output Current Derating

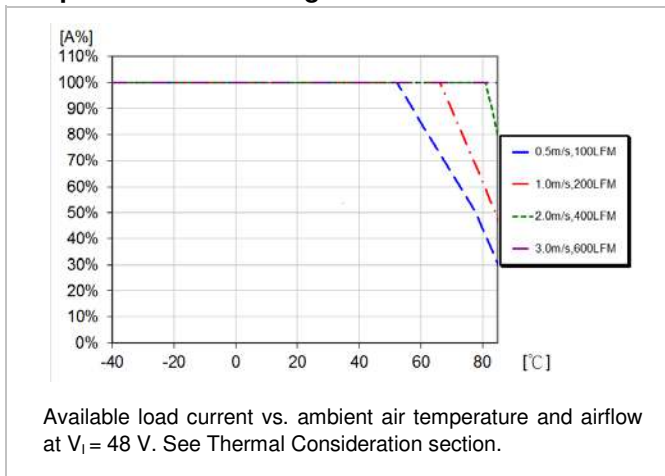

Current Limit Characteristics

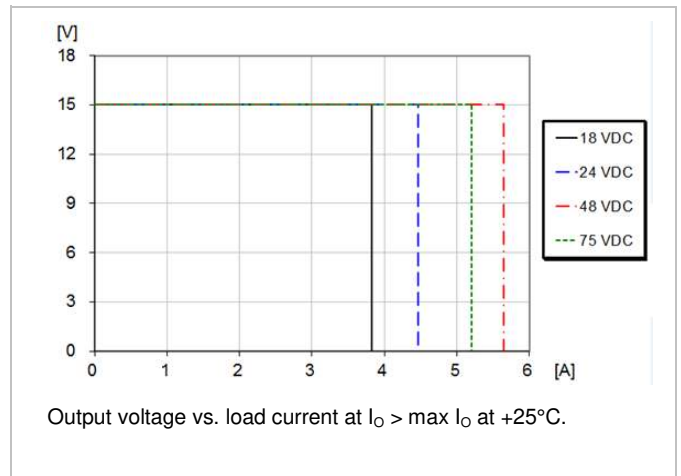

Output Characteristics

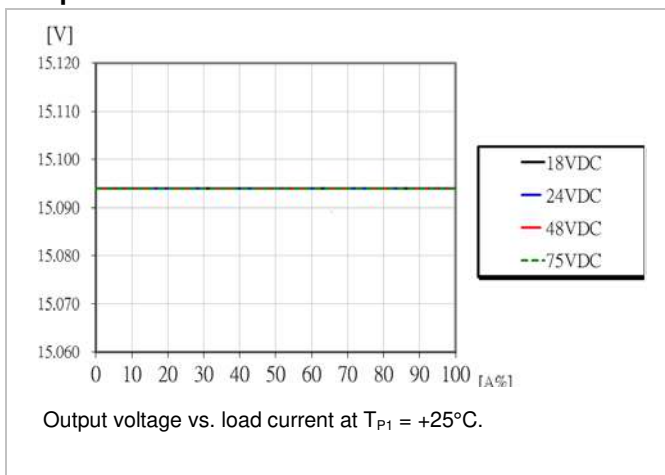

PKU 5500S series DC-DC Converters
Input 18 - 75 V, Output up to 15 A / 50 W

2/28701- BMR 713 Rev. D

May 2021

© Flex

Typical Characteristics
15 V, 3.4 A / 50 W

PKU 5515S PI(P)

Start-up

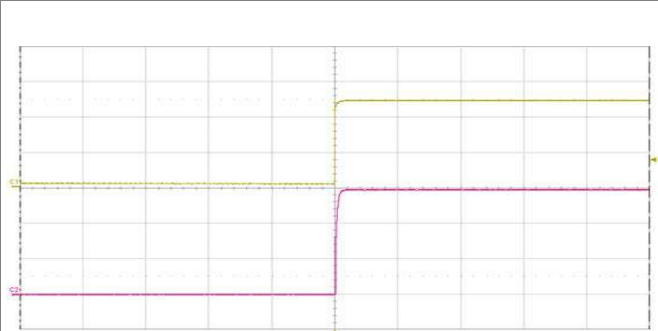

Start-up enabled by connecting V_I at:
 $T_{P1} = +25^{\circ}\text{C}$, $V_I = 48\text{ V}$,
 $I_O = 3.4\text{ A}$ resistive load.

Top trace: output voltage (20 V/div.).
Bottom trace: input voltage (5 V/div.).
Time scale: (200 ms/div.).

Shut-down

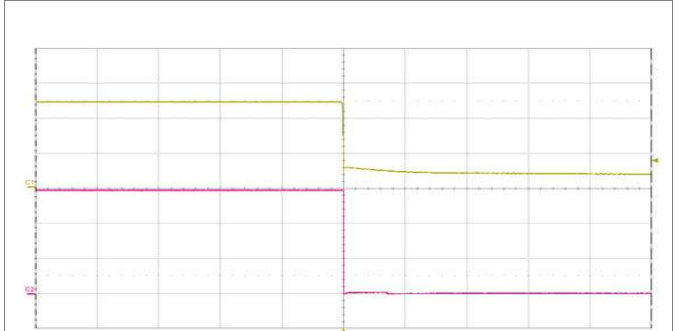

Start-up enabled by connecting V_I at:
 $T_{P1} = +25^{\circ}\text{C}$, $V_I = 48\text{ V}$,
 $I_O = 3.4\text{ A}$ resistive load.

Top trace: output voltage (20 V/div.).
Bottom trace: input voltage (5 V/div.).
Time scale: (200 ms/div.).

Output Ripple & Noise

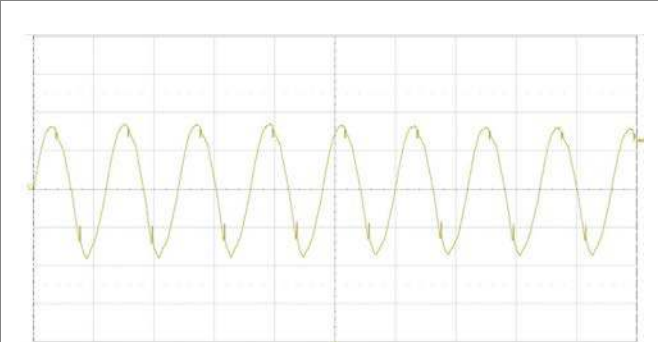

Output voltage ripple at:
 $T_{P1} = +25^{\circ}\text{C}$, $V_I = 48\text{ V}$,
 $I_O = 3.4\text{ A}$ resistive load.

Trace: output voltage (20 mV/div.).
Time scale: (2 μs/div.).
20 MHz bandwidth.

Output Load Transient Response

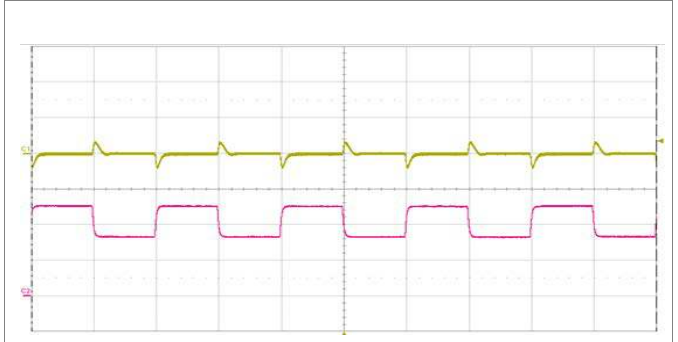

Output voltage response to load current step-change (1.7-2.55-1.7 A) at:
 $T_{P1} = +25^{\circ}\text{C}$, $V_I = 48\text{ V}$.

Top trace: output voltage (500 mV/div.).
Bottom trace: load current (1 A/div.).
Time scale: (2 ms/div.).

Output Voltage Adjust (TRIM UP/TRIM DOWN)

Output Voltage = 15 V

The resistor value for an adjusted output voltage is calculated by using the following equations:

Output Voltage Adjust, Increase:

$$R_{ADJ_UP} = \left(\frac{1.213}{\Delta} - 10 \right) k\Omega$$

Output Voltage Adjust, Decrease:

$$R_{ADJ_DOWN} = \left(\frac{1.487}{\Delta} - 3.7 \right) k\Omega$$

Example:

To trim up the 15 V model by 8% to 16.2 V the required external resistor is:

$$R_{ADJ_UP} = \left(\frac{1.213}{0.08} - 10 \right) = 5.1625k\Omega$$

Example:

To trim down the 15 V model by 7% to 13.95 V the required external resistor is:

$$R_{ADJ_DOWN} = \left(\frac{1.487}{0.07} - 3.7 \right) = 17.543k\Omega$$

Technical Specification

PKU 5500S series DC-DC Converters
Input 18 - 75 V, Output up to 15 A / 50 W

2/28701- BMR 713 Rev. D

May 2021

© Flex

Electrical Specification

24 V, 2.1 A / 50 W

PKU 5516ZS PI(P)

Typical values given at: $T_{P1} = +25^{\circ}\text{C}$, $V_I = 48\text{ V}$ max I_O , unless otherwise specified under Conditions.

Additional $C_{in} = 220\ \mu\text{F}$, $C_{out} = 4.7\ \mu\text{F}$ ceramic Cap + $47\ \mu\text{F}$ tantalum Cap. See Operating Information section for selection of capacitor types.

Characteristics		Conditions	min	typ	max	Unit
V_I	Input voltage range		18		75	V
V_{loff}	Turn-off input voltage	Decreasing input voltage	13.5	14.3	14.5	V
V_{lon}	Turn-on input voltage	Increasing input voltage	14.8	15.5	18.0	V
C_I	Internal input capacitance			2.2		μF
P_O	Output power	$V_I = 18\text{-}36\text{ V}$	0		40	W
		$V_I = 36\text{-}75\text{ V}$	0		50	W
η	Efficiency	50% of max I_O , $V_I = 24\text{ V}$		90		%
		max I_O , $V_I = 24\text{ V}$		90		
		50% of max I_O , $V_I = 48\text{ V}$		90		
		max I_O , $V_I = 48\text{ V}$		91		
P_d	Power Dissipation	max I_O		4.5		W
P_{ii}	Input idling power	$I_O = 0\text{ A}$, $V_I = 48\text{ V}$		0.8		W
P_{RC}	Input standby power	$V_I = 48\text{ V}$ (turned off with RC)		0.4		W
f_s	Switching frequency	0-100 % of max I_O	374	440	506	kHz

V_{O_i}	Output voltage initial setting and accuracy	$T_{P1} = +25^{\circ}\text{C}$, $V_I = 48\text{ V}$, $I_O = 2.1\text{ A}$	23.76	24	24.24	V
V_O	Output adjust range	See operating information	21.6	24	26.4	V
	Output voltage tolerance band	0-100% of max I_O	23.76		24.24	V
	Idling voltage	$I_O = 0\text{ A}$	23.76		24.24	V
	Line regulation	max I_O		120	240	mV
	Load regulation	$V_I = 48\text{ V}$, 25-100% of max I_O		240	480	mV
V_{tr}	Load transient voltage deviation	$V_I = 48\text{ V}$, Load step 50-75-50% of max I_O , $di/dt = 100\text{mA}/\mu\text{s}$		± 400		mV
t_{tr}	Load transient recovery time			300	500	μs
t_r	Ramp-up time (from 10-90% of V_{O_i})	10-100% of max I_O		8		ms
t_s	Start-up time (from V_I connection to 90% of V_{O_i})			10		ms
t_{RC}	RC start-up time (from V_{RC} connection to 90% of V_{O_i})	max I_O		8		ms
RC	Sink current, see Note 1	See operating information	0.5			mA
	Trigger level	Decreasing / Increasing RC-voltage		0.8/2.5		V
I_O	Output current	$V_I = 18\text{-}36\text{ V}$	0		1.8	A
		$V_I = 36\text{-}75\text{ V}$	0		2.1	A
I_{lim}	Current limit threshold	$V_I = 48\text{ V}$, $T_{P1} < \text{max } T_{P1}$		3.2	4.2	A
I_{sc}	Short circuit current	$T_{P1} = 25^{\circ}\text{C}$, see Note 2		0.460		A
C_{out}	Recommended Capacitive Load	$T_{P1} = 25^{\circ}\text{C}$	0		1000	μF
V_{Oac}	Output ripple & noise	See ripple & noise section, V_{O_i} , max I_O , see Note 3		80	100	mVp-p
OVP	Over voltage protection	$T_{P1} = +25^{\circ}\text{C}$, $V_I = 48\text{ V}$, 0-100% of max I_O		28		V

Note 1: Sink current drawn by external device connected to the RC pin.

Note 2: Hiccup mode, RMS value, see Operating Information section.

Note 3: Measured with $4.7\ \mu\text{F}$ ceramic Cap. and $47\ \mu\text{F}$ tantalum Cap. cross to output.

PKU 5500S series DC-DC Converters
Input 18 - 75 V, Output up to 15 A / 50 W

2/28701- BMR 713 Rev. D

May 2021

© Flex

Typical Characteristics
24 V, 2.1 A / 50 W

PKU 5516ZS PI(P)

Efficiency

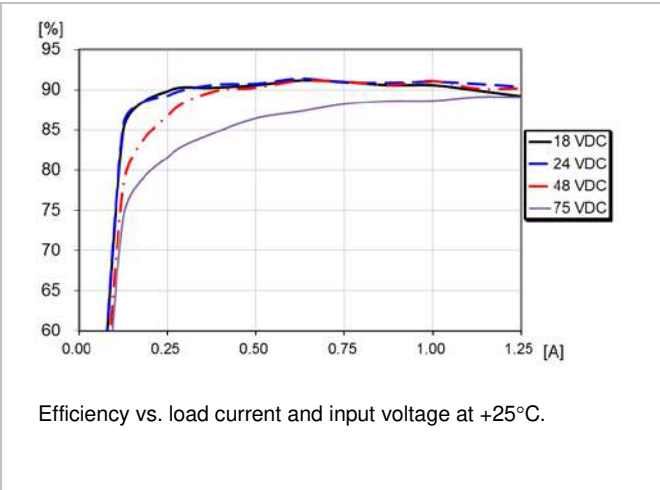

Power Dissipation

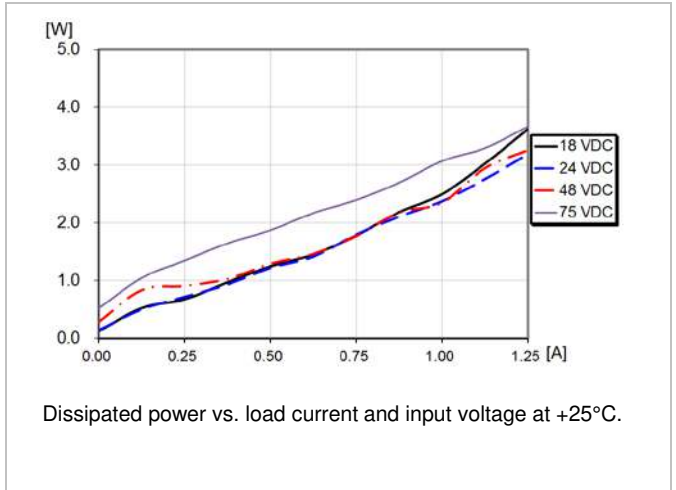

Output Current Derating

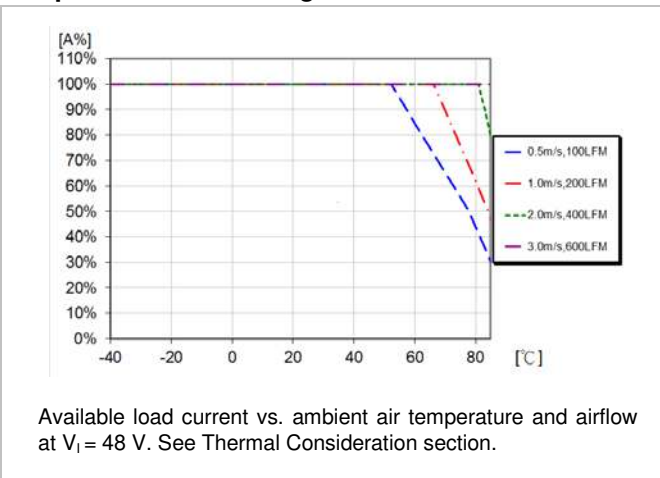

Current Limit Characteristics

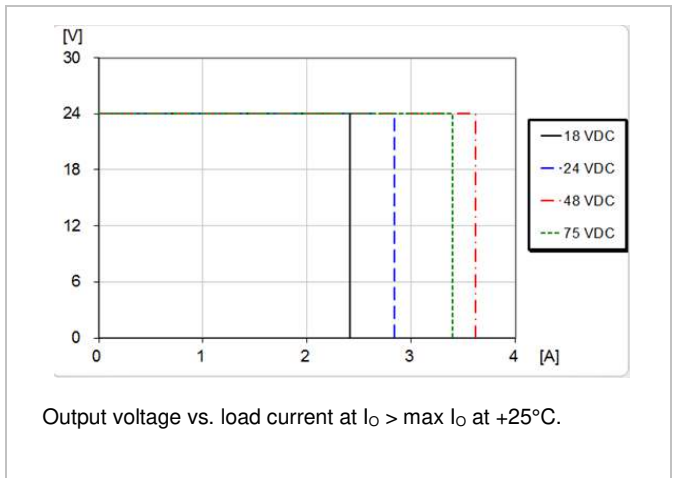

Output Characteristics

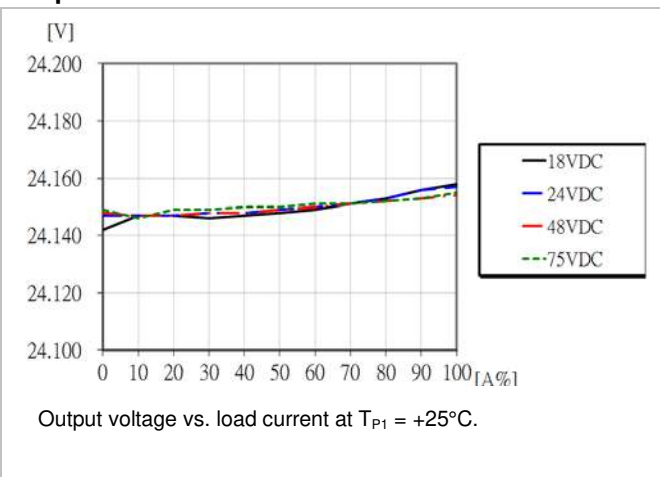

PKU 5500S series DC-DC Converters
Input 18 - 75 V, Output up to 15 A / 50 W

2/28701- BMR 713 Rev. D

May 2021

© Flex

Typical Characteristics
24 V, 2.1 A / 50 W

PKU 5516ZS PI(P)

Start-up

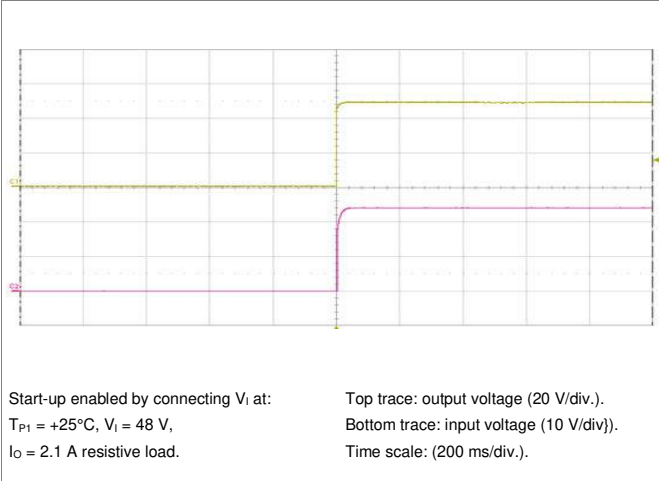

Shut-down

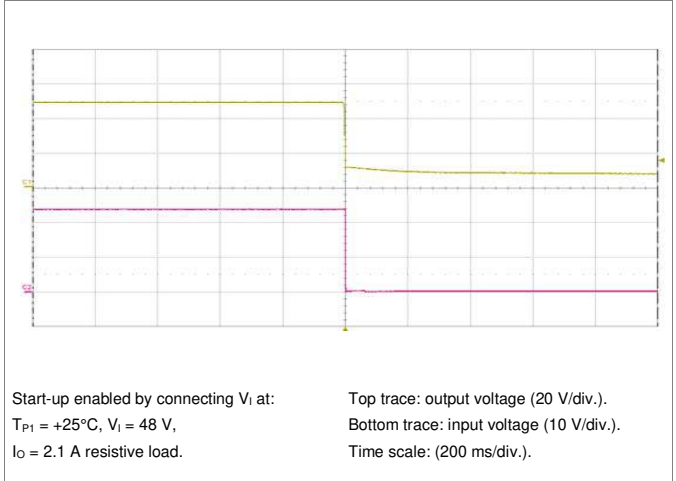

Output Ripple & Noise

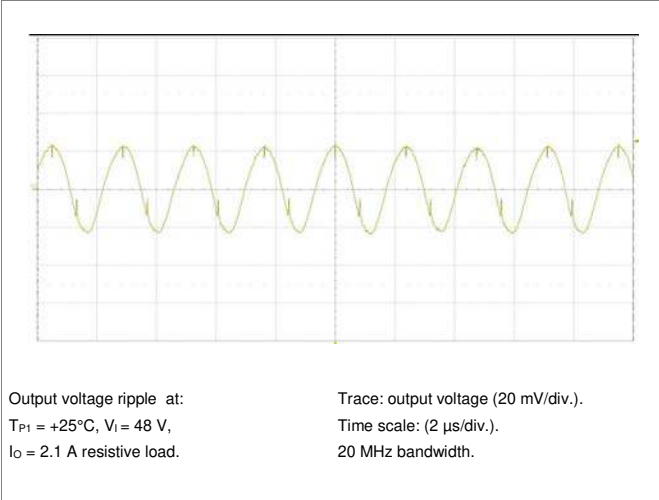

Output Load Transient Response

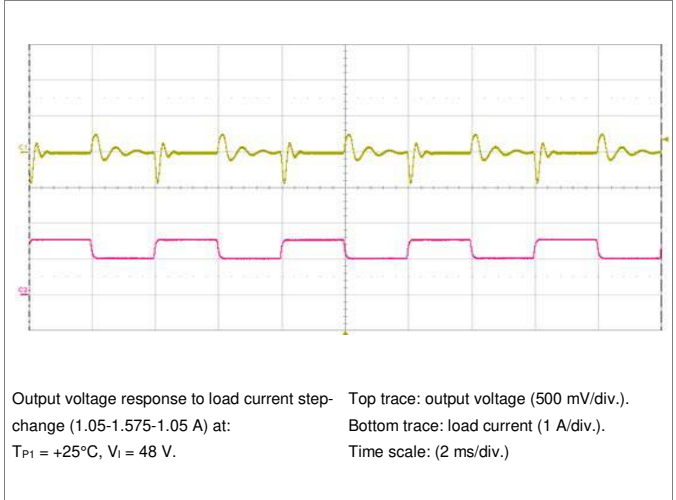

Output Voltage Adjust (TRIM UP/TRIM DOWN)

Output Voltage = 24 V

The resistor value for an adjusted output voltage is calculated by using the following equations:

Output Voltage Adjust, Increase:

$$R_{ADJ_UP} = \left(\frac{1.948}{\Delta} - 18 \right) k\Omega$$

Output Voltage Adjust, Decrease:

$$R_{ADJ_DOWN} = \left(\frac{2.352}{\Delta} - 22.3 \right) k\Omega$$

Example:

To trim up the 24 V model by 8% to 25.92 V the required external resistor is:

$$R_{ADJ_UP} = \left(\frac{1.948}{0.08} - 18 \right) = 6.35k\Omega$$

Example:

To trim down the 24 V model by 7% to 22.32 V the required external resistor is:

$$R_{ADJ_DOWN} = \left(\frac{2.352}{0.07} - 22.3 \right) = 11.3k\Omega$$

Technical Specification

PKU 5500S series DC-DC Converters
 Input 18 - 75 V, Output up to 15 A / 50 W

2/28701- BMR 713 Rev. D May 2021
 © Flex

EMC Specification

Conducted EMI measured according to EN55032, CISPR 32 and FCC part 15J (see test set-up). See Design Note 009 for further information. The fundamental switching frequency is 440 kHz for PKU 5513S (50W/12V) at $V_1 = 48$ V and max I_o .

Conducted EMI Input terminal value (typ)

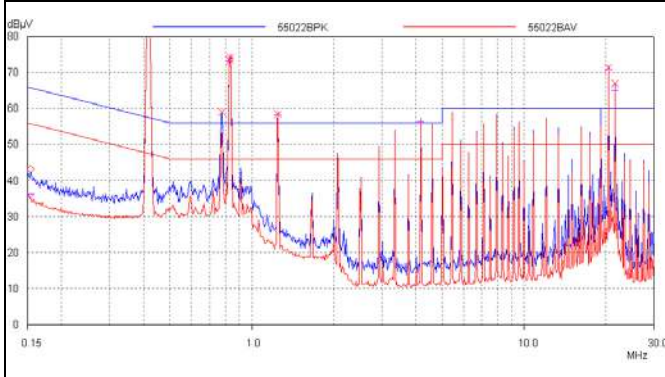

EMI without filter

Optional external filter for class B

Suggested external input filter in order to meet class B in EN 55032, CISPR 32 and FCC part 15J.

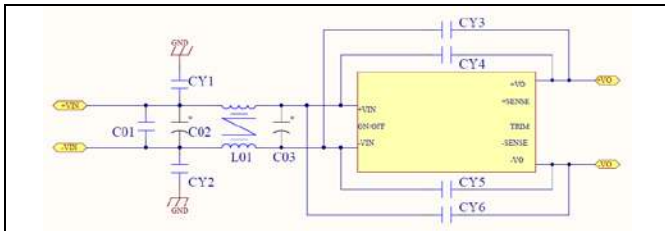

Filter components:

- C01: 2.2 μ F/100 V CERAMIC
- C02: 150 μ F/100 V E.L. capacitor
- C03: 100 μ F/100 V E.L. capacitor
- L01: 3.25 mH
- CY1, CY2: 20 nF, CY3, CY6: 10 nF, CY4: 2.2 nF, CY5: 4.7 nF

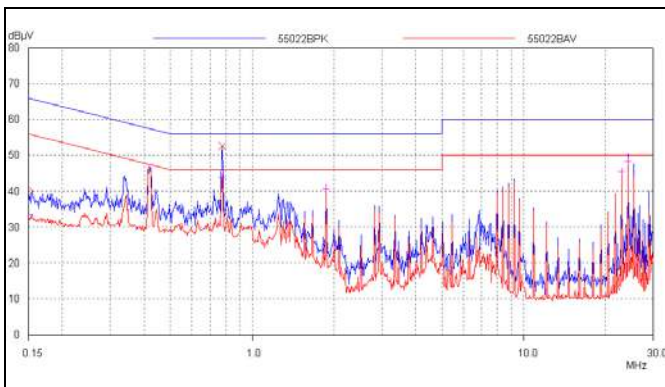

EMI with filter

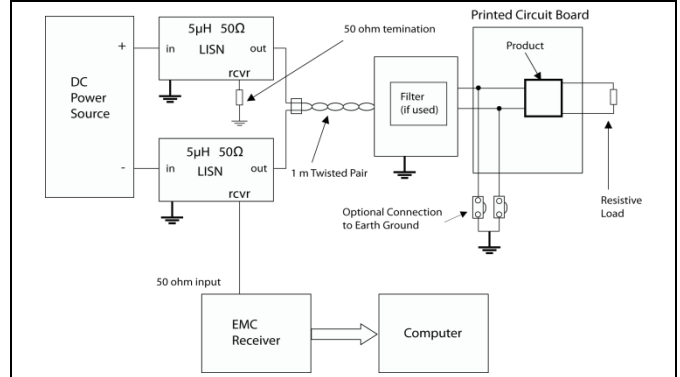

Test set-up

Layout recommendations

The radiated EMI performance of the product will depend on the PWB layout and ground layer design. It is also important to consider the stand-off of the product. If a ground layer is used, it should be connected to the output of the product and the equipment ground or chassis.

A ground layer will increase the stray capacitance in the PWB and improve the high frequency EMC performance.

Output ripple and noise

Output ripple and noise measured according to figure below. See Design Note 022 for detailed information.

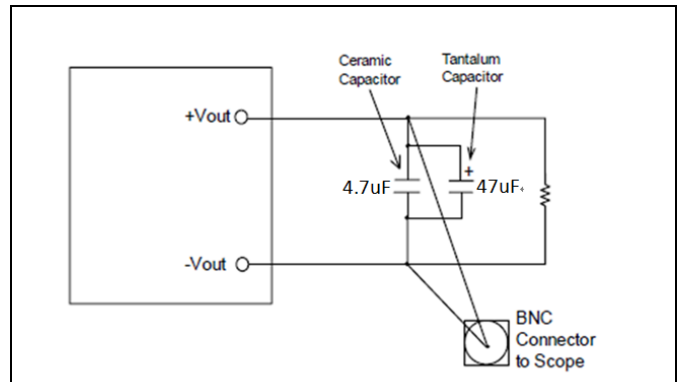

Output ripple and noise test setup

Technical Specification

PKU 5500S series DC-DC Converters
Input 18 - 75 V, Output up to 15 A / 50 W

2/28701- BMR 713 Rev. D

May 2021

© Flex

Operating Information

Input Voltage

The input voltage range 18 to 75 Vdc , At input voltages exceeding 75 V, the power loss will be higher than at normal input voltage and T_{P1} must be limited to absolute max +105°C. The absolute maximum continuous input voltage is 75 Vdc.

Short duration transient disturbances can occur on the DC distribution and input of the product when a short circuit fault occurs on the equipment side of a protective device (fuse or circuit breaker). The voltage level, duration and energy of the disturbance are dependant on the particular DC distribution network characteristics and can be sufficient to damage the product unless measures are taken to suppress or absorb this energy. The transient voltage can be limited by capacitors and other energy absorbing devices like zener diodes connected across the positive and negative input conductors at a number of strategic points in the distribution network. The end-user must secure that the transient voltage will not exceed the value stated in the Absolute maximum ratings. ETSI TR 100 283 examines the parameters of DC distribution networks and provides guidelines for controlling the transient and reduce its harmful effect.

Turn-off Input Voltage

The products monitor the input voltage and will turn on and turn off at predetermined levels. The minimum hysteresis between turn on and turn off input voltage is 1.7 V.

Remote Control (RC)

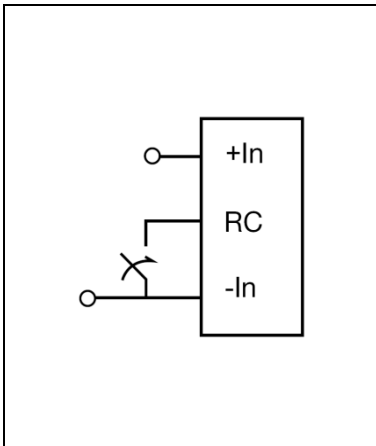

The products are fitted with a remote control function referenced to the primary negative input connection (-In), with negative and positive logic options available. The RC function allows the product to be turned on/off by an external device like a semiconductor or mechanical switch. The RC pin has an internal pull up resistor to +In.

The external device must provide a minimum required sink current to guarantee a voltage not higher than maximum voltage on the RC pin (see Electrical characteristics table). When the RC pin is left open, the voltage generated on the RC pin is 3 - 5 V.

The standard product is provided with “negative logic” RC and will be on until the RC pin is connected to the -In. To turn off the product the RC pin should be left open, or connected to a

voltage higher than 2.5 V referenced to -In. In situations where it is desired to have the product to power up automatically without the need for control signals or a switch, the RC pin can be wired directly to -In.

The second option is “positive logic” remote control, which can be ordered by adding the suffix “P” to the end of the part number. When the RC pin is left open, the product starts up automatically when the input voltage is applied. Turn off is achieved by connecting the RC pin to the -In. The product will restart automatically when this connection is opened.

See Design Note 021 for detailed information.

Input and Output Impedance

The impedance of both the input source and the load will interact with the impedance of the product. It is important that the input source has low characteristic impedance. The products are designed for stable operation without external capacitors connected to the input or output. The performance in some applications can be enhanced by addition of external capacitance as described under External Decoupling Capacitors.

If the input voltage source contains significant inductance, the addition of a 220 μ F capacitor across the input of the product will ensure stable operation. The capacitor is not required when powering the product from an input source with an inductance below 10 μ H. The minimum required capacitance value depends on the output power and the input voltage. The higher output power the higher input capacitance is needed. Approximately doubled capacitance value is required for a 24 V input voltage source compared to a 48 V input voltage source.

External Decoupling Capacitors

When powering loads with significant dynamic current requirements, the voltage regulation at the point of load can be improved by addition of decoupling capacitors at the load. The most effective technique is to locate low ESR ceramic and electrolytic capacitors as close to the load as possible, using several parallel capacitors to lower the effective ESR. The ceramic capacitors will handle high-frequency dynamic load changes while the electrolytic capacitors are used to handle low frequency dynamic load changes. It is equally important to use low resistance and low inductance PWB layouts and cabling.

External decoupling capacitors will become part of the product’s control loop. The control loop is optimized for a wide range of external capacitance and the maximum recommended value that could be used without any additional analysis is found in the Electrical specification. The ESR of the capacitors is a very important parameter. Stable operation is guaranteed with a verified ESR value of >5 m Ω across the output connections. For further information please contact your local Flex representative.

Technical Specification

PKU 5500S series DC-DC Converters
Input 18 - 75 V, Output up to 15 A / 50 W

2/28701- BMR 713 Rev. D

May 2021

© Flex

Output Voltage Adjust (V_{adj})

The products have an Output Voltage Adjust pin (V_{adj}). This pin can be used to adjust the output voltage above or below Output voltage initial setting.

When increasing the output voltage, the voltage at the output pins (including any remote sense compensation) must be kept below the threshold of the over voltage protection, (OVP) to prevent the product from shutting down. At increased output voltages the maximum power rating of the product remains the same, and the max output current must be decreased correspondingly.

To increase the voltage the resistor should be connected between the V_{adj} pin and +Out pin. The resistor value of the Output voltage adjust function is according to information given under the Output section for the respective product. To decrease the output voltage, the resistor should be connected between the V_{adj} pin and -Out pin.

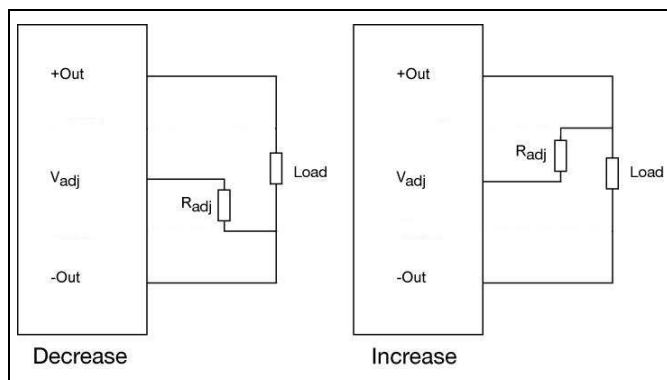
**Remote Sense**

The products have remote sense that can be used to compensate for voltage drops between the output and the point of load. The sense traces should be located close to the PWB ground layer to reduce noise susceptibility. The remote sense circuitry will compensate for up to 10% voltage drop between output pins and the point of load.

If the remote sense is not needed +Sense should be connected to +Out and -Sense should be connected to -Out.

Over Temperature Protection (OTP)

The products are protected from thermal overload by an internal over temperature shutdown circuit.

When T_{P1} as defined in thermal consideration section exceeds 105°C the product will shut down. The product will make continuous attempts to start up (non-latching mode) and resume normal operation automatically when the temperature has dropped >3°C below the temperature threshold.

Over Voltage Protection (OVP)

The products have output over voltage protection that will prevent output voltage to exceed the specified value in

technical specification. The product will make continuous attempts to start up (non-latching mode) and resume normal operation automatically after removal of the over voltage condition.

Over Current Protection (OCP)

The products include current limiting circuitry for protection at continuous overload. The output voltage will decrease towards zero for output currents in excess of max output current (I_o). The product will resume normal operation after removal of the overload. The load distribution should be designed for the maximum output short circuit current specified.

Thermal Consideration**General**

The products are designed to operate in different thermal environments and sufficient cooling must be provided to ensure reliable operation.

For products mounted on a PWB without a heat sink attached, cooling is achieved mainly by conduction, from the pins to the host board, and convection, which is dependent on the airflow across the product. Increased airflow enhances the cooling of the product. The Output Current Derating graph found in the Output section for each model provides the available output current vs. ambient air temperature and air velocity at $V_i = 48$ V.

The product is tested on a 100 x 100 mm, 70 μ m (2 oz), 1-layer test board in a wind box with 255 x 63 mm.

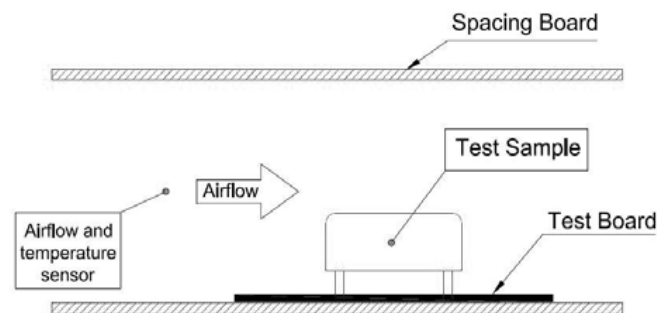
**Definition of product operating temperature**

The product operating temperatures is used to monitor the temperature of the product, and proper thermal conditions can be verified by measuring the temperature at positions P1. The temperature at this position (T_{P1}) should not exceed the maximum temperatures in the table below. Temperature above maximum T_{P1} , measured at the reference point P1 are not allowed and may cause permanent damage.

Technical Specification

PKU 5500S series DC-DC Converters
 Input 18 - 75 V, Output up to 15 A / 50 W

2/28701- BMR 713 Rev. D

May 2021

© Flex

Position	Description	Max Temp.
P1	Reference point	T _{P1} =100° C

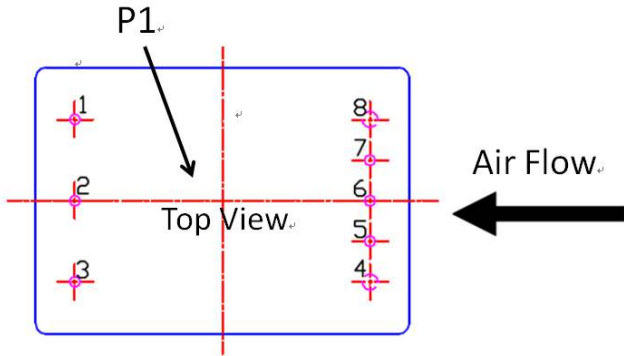

Reference point on PKU 55XXS variant

Connections

Cu Metal Case Type (Pin Length: 0.18")

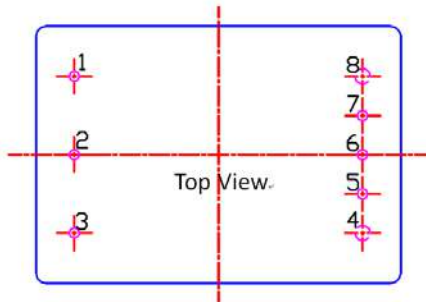

Pin	Designation	Function
1	Vin(+)	Positive input
2	On/Off Control	Remote control
3	Vin(-)	Negative input
4	Vout(-)	Negative output
5	Sense(-)	Negative remote sense
6	Trim	Output voltage adjust
7	Sense(+)	Positive remote sense
8	Vout(+)	Positive output

Technical Specification

PKU 5500S series DC-DC Converters
Input 18 - 75 V, Output up to 15 A / 50 W

2/28701- BMR 713 Rev. D

May 2021

© Flex

Mechanical Information

Cu Metal Case Type (Pin Length: 0.18")

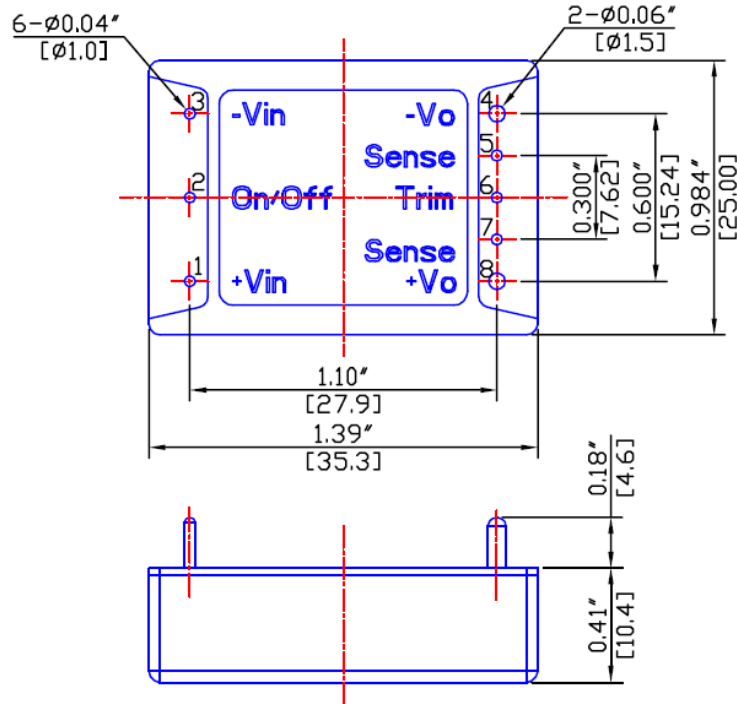

Weight : Typical 28 g

All dimensions in inches (mm).

Note 1: Pin 1,2,3,5,6,7 size is 0.04 ± 0.005 inches
(1.0 mm) dia.

Pin 4,8 size is 0.06 ± 0.005 inches (1.5
mm) dia.

Note 2: Tolerance .xx= ± 0.02 "

.xxx= ± 0.020 "

Technical Specification

PKU 5500S series DC-DC Converters
Input 18 - 75 V, Output up to 15 A / 50 W

2/28701- BMR 713 Rev. D

May 2021

© Flex

Soldering Information - Hole Mounting

The hole mounted product is intended for plated through hole mounting by wave or manual soldering. The pin temperature is specified to maximum to 270°C for maximum 10 seconds.

A maximum preheat rate of 4°C/s and maximum preheat temperature of 150°C is suggested. When soldering by hand, care should be taken to avoid direct contact between the hot soldering iron tip and the pins for more than a few seconds in order to prevent overheating.

A no-clean flux is recommended to avoid entrapment of cleaning fluids in cavities inside the product or between the product and the host board. The cleaning residues may affect long time reliability and isolation voltage.

Delivery Package Information

The products are delivered in antistatic clamshell trays

Cu Metal Case

Tray Specifications	
Material	Antistatic PS
Surface resistance	$10^3 < \text{Ohm/square} < 10^9$
Bakability	This tray is not bake-able
Tray thickness	23.4 mm [0.92125 inch]
Box capacity	160 products (8 full trays/box)
Tray weight	60 g empty, 600 g full tray

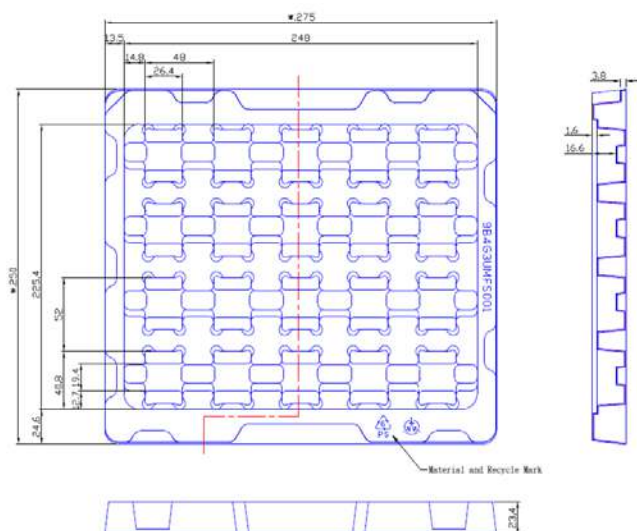
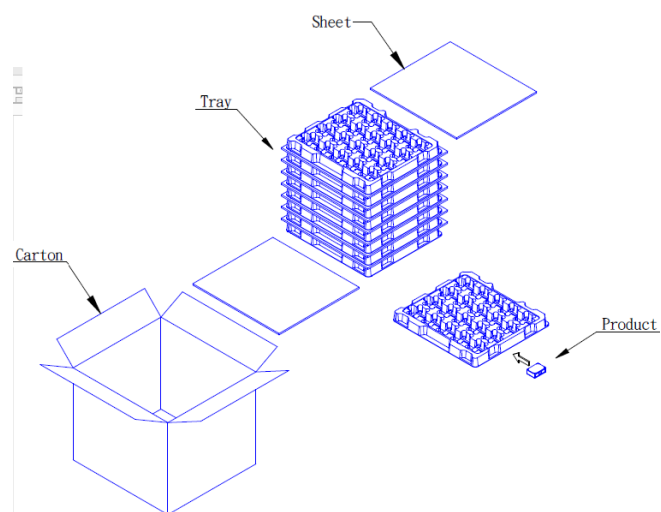
Package

Technical Specification

PKU 5500S series DC-DC Converters Input 18 - 75 V, Output up to 15 A / 50 W	2/28701- BMR 713 Rev. D	May 2021
	© Flex	

Product Qualification Specification

Characteristics			
External visual inspection	IPC-A-610		
Change of temperature (Temperature cycling)	IEC 60068-2-14 Na	Temperature range Number of cycles Dwell/transfer time	-55 to 105°C 20 30 min/3 min
Cold (in operation)	IEC 60068-2-1 Ad	Temperature T _A Duration	-45°C 72 h
Damp heat	IEC 60068-2-30	Temperature Humidity Duration	45°C 95 % RH 72 hours
Dry heat	IEC 60068-2-2 Bd	Temperature Duration	125°C 1000 h
Electrostatic discharge susceptibility	IEC 61340-3-1, JESD 22-A114	Human body model (HBM)	Class 2, 2000 V
Immersion in cleaning solvents	IEC 60068-2-45 XA, method 2	Water Glycol ether {Isopropyl alcohol}	55°C 35°C {35°C}
Mechanical shock	IEC 60068-2-27 Ea	Peak acceleration Duration	200 g 6 ms
Moisture reflow sensitivity ¹	J-STD-020E	Level 1 (SnPb-eutectic) Level 3 (Pb Free)	225°C 260°C
Operational life test	MIL-STD-202G, method 108A	Duration	1000 h
Resistance to soldering heat	IEC 60068-2-20 Tb, method 1A	Solder temperature Duration	270°C 10-13 s
Robustness of terminations	IEC 60068-2-21 Test Ua1	Through hole mount products	All leads
Solderability	IEC 60068-2-20 test Ta ¹	Preconditioning Temperature, SnPb Eutectic Temperature, Pb-free	235°C 245°C
Vibration, broad band random	IEC 61373	Frequency RMS acceleration Duration	5 to 150 Hz 5 grms 5 hrs in each direction

Notes

¹ Only for products intended for wave soldering (plated through hole products)