



Is Now Part of



ON Semiconductor®

To learn more about ON Semiconductor, please visit our website at
www.onsemi.com

Please note: As part of the Fairchild Semiconductor integration, some of the Fairchild orderable part numbers will need to change in order to meet ON Semiconductor's system requirements. Since the ON Semiconductor product management systems do not have the ability to manage part nomenclature that utilizes an underscore (_), the underscore (_) in the Fairchild part numbers will be changed to a dash (-). This document may contain device numbers with an underscore (_). Please check the ON Semiconductor website to verify the updated device numbers. The most current and up-to-date ordering information can be found at www.onsemi.com. Please email any questions regarding the system integration to Fairchild_questions@onsemi.com.

ON Semiconductor and the ON Semiconductor logo are trademarks of Semiconductor Components Industries, LLC dba ON Semiconductor or its subsidiaries in the United States and/or other countries. ON Semiconductor owns the rights to a number of patents, trademarks, copyrights, trade secrets, and other intellectual property. A listing of ON Semiconductor's product/patent coverage may be accessed at www.onsemi.com/site/pdf/Patent-Marking.pdf. ON Semiconductor reserves the right to make changes without further notice to any products herein. ON Semiconductor makes no warranty, representation or guarantee regarding the suitability of its products for any particular purpose, nor does ON Semiconductor assume any liability arising out of the application or use of any product or circuit, and specifically disclaims any and all liability, including without limitation special, consequential or incidental damages. Buyer is responsible for its products and applications using ON Semiconductor products, including compliance with all laws, regulations and safety requirements or standards, regardless of any support or applications information provided by ON Semiconductor. "Typical" parameters which may be provided in ON Semiconductor data sheets and/or specifications can and do vary in different applications and actual performance may vary over time. All operating parameters, including "Typicals" must be validated for each customer application by customer's technical experts. ON Semiconductor does not convey any license under its patent rights nor the rights of others. ON Semiconductor products are not designed, intended, or authorized for use as a critical component in life support systems or any FDA Class 3 medical devices or medical devices with a same or similar classification in a foreign jurisdiction or any devices intended for implantation in the human body. Should Buyer purchase or use ON Semiconductor products for any such unintended or unauthorized application, Buyer shall indemnify and hold ON Semiconductor and its officers, employees, subsidiaries, affiliates, and distributors harmless against all claims, costs, damages, and expenses, and reasonable attorney fees arising out of, directly or indirectly, any claim of personal injury or death associated with such unintended or unauthorized use, even if such claim alleges that ON Semiconductor was negligent regarding the design or manufacture of the part. ON Semiconductor is an Equal Opportunity/Affirmative Action Employer. This literature is subject to all applicable copyright laws and is not for resale in any manner.



FSA8029

Audio Jack Send / End Detection with MIC / Video Switch

Features

Detection	Accessory Plug-In 3- or 4-Pole Audio Jack Send / End Key Pressed
Switch Type	Microphone & Video
V _{DD}	2.5 to 4.3V
THD (MIC)	0.01% Typical
ESD (Air Gap)	16kV
Operating Temperature	-40°C to 85°C
Package	10-Lead UMLP 1.4x1.8x0.5mm, 0.4mm Pitch
Top Mark	KS
Ordering Information	FSA8029UMX

Description

The FSA8029 is an audio jack microphone / video switch for 3- or 4-pole accessories with send / end (S/E) detection. In addition to detection, the FSA8029 features an integrated microphone / video switch that allows the processor to configure the audio jack. The architecture is designed to allow common third-party headphones to be used for listening to music from mobile handsets, personal media players, and portable peripheral devices.

- Determines when Send / End Button Key is Pressed
- Integrates a MIC / Video Switch for 4-Pole Configuration
- Reduces Pop / Click Caused by Microphone Bias

Related Resources

- For samples and questions, please contact: Analog.Switch@fairchildsemi.com.
- FSA8029 Demonstration Board

Applications

- 3.5mm and 2.5mm Audio Jacks
- Cellular Phones, Smartphones
- MP3 and PMP

Typical Application

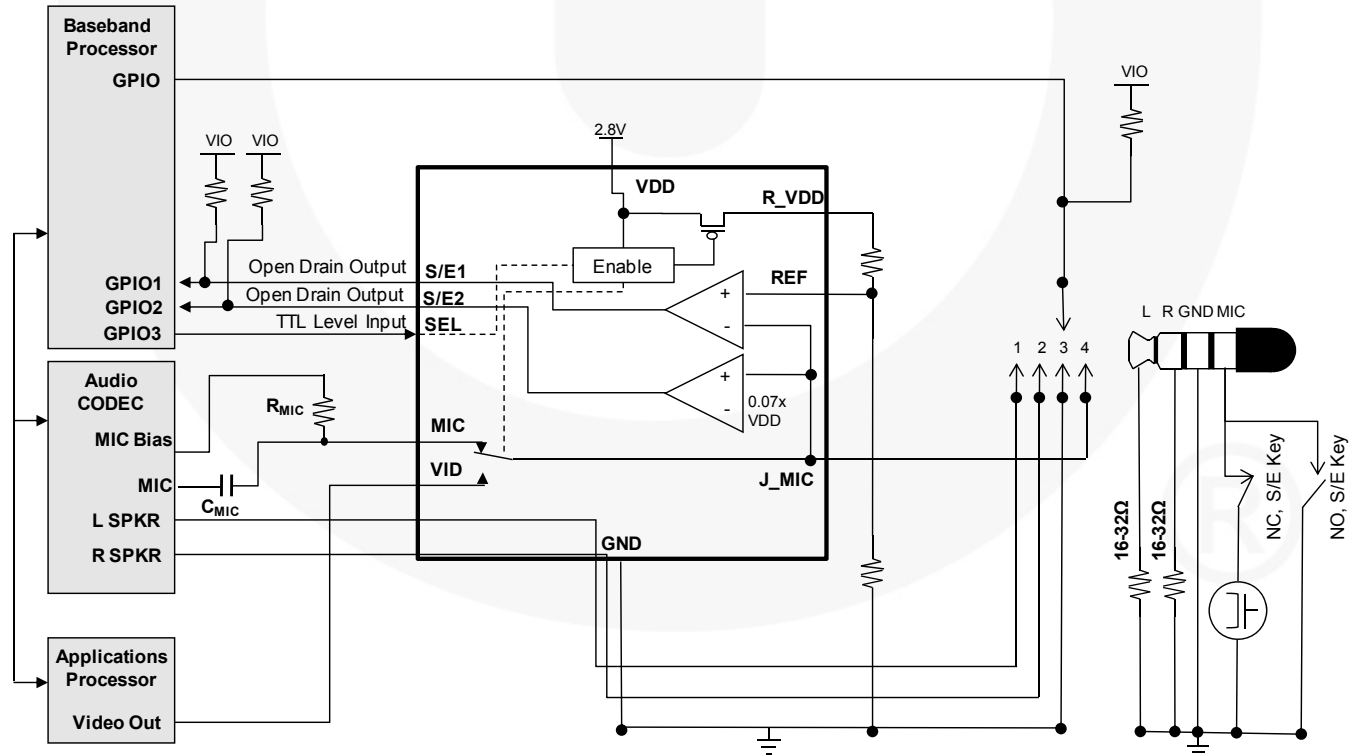

Figure 1. Mobile Phone Example

Pin Configuration

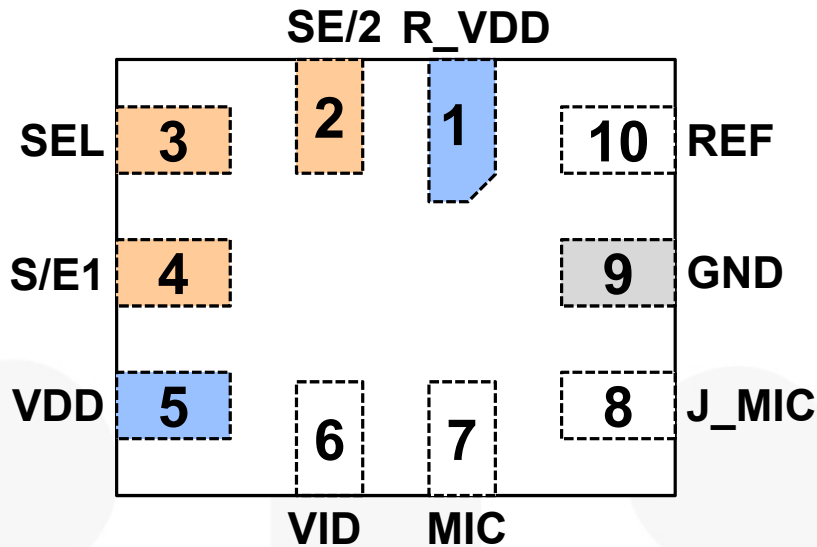

Figure 2. Pin Assignments (Through View)

Pin Descriptions

Name	Pin #	Type	Description
R_VDD	1	Output	Optional pull-up voltage, with a resistor divider, sets the reference voltage on the REF pin
S/E2	2	Output	Indicates state of normally open (N/O) send / end key press; open-drain output requires pull-up resistor
SEL	3	Input	MIC / VID switch select pin
			0
S/E1	4	Output	Indicates state of normally closed (N/C) send / end key press; open-drain output requires pull-up resistor
			0
VID	6	Switch	Video switch path; connects between video source and audio jack microphone pin
MIC	7	Switch	Microphone switch path to the CODEC microphone amplifier input
J_MIC	8	Switch	Microphone switch path connects to the microphone, send / end key, and video of the jack pole
REF	10	Input	Reference voltage used to detect a send / end key press through a resistor divider off R_VDD or external voltage reference
VDD	5	Power	Supply voltage
GND	9	Ground	Ground for both the audio jack and PCB

Note:

1. 0 = V_{OL} or V_{IL} ; 1 = V_{OH} or V_{IH} .

Table 1. Device Configuration in Reset and Active States

SEL	MIC	VID	R_VDD	S/E1 + S/E2
1	J_MIC	Open	VDD	Active
0	Open	J_MIC	GND	HIGH

Absolute Maximum Ratings

Stresses exceeding the absolute maximum ratings may damage the device. The device may not function or be operable above the recommended operating conditions and stressing the parts to these levels is not recommended. In addition, extended exposure to stresses above the recommended operating conditions may affect device reliability. The absolute maximum ratings are stress ratings only.

Symbol	Parameter		Min.	Max.	Units
V _{DD}	Supply Voltage from Battery		-0.5	5.5	V
V _{SW}	Switch I/O Voltage		-0.5	V _{DD} +0.5	V
I _{IK}	Input Clamp Diode Current ⁽²⁾		-50		mA
I _{SW}	Switch I/O Current (Continuous) ⁽²⁾			50	mA
T _{STG}	Storage Temperature Range		-65	+150	°C
T _J	Maximum Junction Temperature			+150	°C
T _L	Lead Temperature (Soldering, 10 Seconds)			+260	°C
ESD	IEC 61000-4-2 System ESD	Air Gap	16		kV
		Contact	10		
	Human Body Model, JEDEC JESD22-A114	All other Pins	5		
		J_DET, J_MIC, V _{DD} , V _{IO} , GND	8		
	Charged Device Model, JEDEC JESD22-C101	All Pins	2		

Note:

2. The input and output negative ratings may be exceeded if the input and output diode current ratings are observed.

Recommended Operating Conditions

The Recommended Operating Conditions table defines the conditions for actual device operation. Recommended operating conditions are specified to ensure optimal performance to the datasheet specifications. Fairchild does not recommend exceeding them or designing to Absolute Maximum Ratings.

Symbol	Parameter	Min.	Max.	Units
V _{DD}	Battery Supply Voltage	2.5	4.3	V
T _A	Operating Temperature	-40	+85	°C

DC Electrical Characteristics

All typical values are at $T_A = 25^\circ\text{C}$ unless otherwise specified.

MIC Switch

Symbol	Parameter	Conditions	V_{DD} (V)	$T_A = -40$ to $+85^\circ\text{C}$			Units
				Min.	Typ.	Max.	
R_{ON}	MIC Switch On Resistance	$I_{OUT} = 24\text{mA}$, $V_{IN} = 2.2\text{V}$	2.8		2.0	4.0	Ω
			3.0		1.5	3.5	
			3.3		1.2	3.0	
			3.8		1.0	2.5	
$R_{FLAT(ON)}$	On Resistance Flatness	$I_{OUT} = 24\text{mA}$, $V_{IN} = V$ to V_{DD}	2.8		0.7	1.5	Ω
			3.0		0.6	1.4	
			3.3		0.5	1.3	
			3.8		0.5	1.2	
V_{IN}	Switch Input Voltage Range		2.5 to 4.3	0		V_{DD}	V
C_{ON}	MIC and J_MIC Switch ON Capacitance	$f = 1\text{MHz}$	2.8		15		pF
C_{OFF}	MIC and J_MIC Switch OFF Capacitance	$f = 1\text{MHz}$	2.8		8		pF

Video Switch Characteristics

Symbol	Parameter	Conditions	V_{DD} (V)	$T_A = -40$ to $+85^\circ\text{C}$			Unit
				Min.	Typ.	Max.	
R_{ON}	MIC Switch On Resistance	$I_{OUT} = 24\text{mA}$, $V_{IN} = 0.5\text{V}$	2.8		1.0	1.5	Ω
			3.0		0.9	1.4	
			3.3		0.8	1.3	
			3.8		0.7	1.2	
$R_{FLAT(ON)}$	On Resistance Flatness	$I_{OUT} = 24\text{mA}$, $V_{IN} = 0\text{V}$ to 1.2V	2.8		0.4	0.60	Ω
			3.0		0.3	0.55	
			3.3		0.2	0.50	
			3.8		0.15	0.45	
V_{IN}	Switch Input Voltage Range		2.5 to 4.3	0		1.5	V
C_{ON}	VID Switch On Capacitance	$f = 1\text{MHz}$	2.8		40		pF
C_{OFF}	VID Switch Off Capacitance	$f = 1\text{MHz}$	2.8		10		pF

Parallel I/O

Symbol	Parameter	$T_A = -40$ to $+85^\circ\text{C}$			Unit
		Min.	Typ.	Max.	
V_{IH}	Input High Voltage (EN, SEL)	$0.44 \times V_{DD}$		V_{DD}	V
V_{IL}	Input Low Voltage (EN, SEL)	GND		$0.15 \times V_{DD}$	V
$PUR_{S/E}$	Pull-Up Resistor on S/E	2		110	K Ω
V_{OL}	Output Low Voltage (S/E) (V_{PUR} = Voltage of Pull-Up Resistor)			$0.2 \times V_{PUR}$	V

Continued on the following page...

DC Electrical Characteristics (Continued)All typical values are at $T_A = 25^\circ\text{C}$ unless otherwise specified.**Comparator NC Switch**

Symbol	Parameter	$T_A = -40$ to $+85^\circ\text{C}$			Unit
		Min.	Typ.	Max.	
V_{REF}	Input Voltage on REF Pin	1		$V_{DD} - 0.075$	V
COM_{HYS}	Hysteresis of Comparator “-” Terminal		50		mV

Comparator NO Switch

Symbol	Parameter	V_{DD} (V)	$T_A = -40$ to $+85^\circ\text{C}$			Unit
			Min.	Typ.	Max.	
V_{COMP}	Comparator Threshold for Send / End Sensing	2.5 to 4.3		$0.07 \times V_{DD}$		V
COM_{HYS}	Hysteresis of Comparator “+” Terminal			50		mV

Current

Symbol	Parameter	Conditions	V_{DD} (V)	$T_A = -40$ to $+85^\circ\text{C}$			Unit
				Min.	Typ.	Max.	
I_{OFF}	Off-State Leakage Current	$J_{MIC} = 1V, 4.3V,$ MIC or $VID = 4.3V, 1V$	4.3	-15		15	nA
I_{IN}	Input Leakage Current	Inputs 0 to 4.3V	0 to 4.3			1	μA
I_{CC-EN}	Low-Power Mode	$EN = LOW$	2.5 to 4.3		10		nA
I_{CC-VID}	Current During Video Mode	Active Current, $SEL = LOW$	2.5 to 4.3		10		nA
I_{CC-MIC}	Current During Microphone Mode	Active Current, $SEL = HIGH$	2.5 to 4.3		20		μA

AC Electrical Characteristics

All typical values are for $V_{CC} = 3.3V$ at $T_A = 25^\circ C$ unless otherwise specified.

MIC Switch

Symbol	Parameter	Conditions	V_{DD} (V)	$T_A = -40$ to $+85^\circ C$			Unit
				Min.	Typ.	Max.	
THD	Total Harmonic Distortion	$R_T = 600\Omega$, $V_{SW} = 0.5V_{PP}$, $f = 20Hz$ to $20kHz$, $V_{IN} = 2.2V$	2.8		.003		%
O_{IRR}	Off Isolation	$f = 20kHz$, $R_S = 32\Omega$, $C_L = 0pF$, $R_T = 32\Omega$	2.8		-100		dB
X_{TALK}	Crosstalk from MIC to VID	$f = 1MHz$, $R_L = 100\Omega$	2.8		-67		dB

Video Switch Characteristics

Symbol	Parameter	Conditions	V_{DD} (V)	$T_A = -40$ to $+85^\circ C$			Unit
				Min.	Typ.	Max.	
D_G	Differential Gain	$R_L = 150\Omega$, $f = 3.58MHz$	2.8		.09		%
D_P	Differential Phase	$R_L = 150\Omega$, $f = 3.58MHz$	2.8		.13		$^\circ$
O_{IRR}	Off Isolation	$f = 10MHz$, $R_L = 150\Omega$,	2.8		-45		dB
X_{TALK}	Crosstalk from VID to MIC	$f = 10MHz$, $R_{IN} = 10\Omega$, $C_L = 0pF$, $R_L = 150\Omega$	2.8		-65		dB

Parallel I/O

Symbol	Parameter	Conditions	V_{DD} (V)	$T_A = -40$ to $+85^\circ C$			Unit
				Min.	Typ.	Max.	
t_{BBM}	Break-Before-Make Time		2.5 to 4.3		120		ns
$t_{SEL-COM-ON}$	Select to Comparator On	SEL LOW \rightarrow HIGH to Comparator On	2.5 to 4.3		10		μs
$t_{SEL-COM-OFF}$	Select to Comparator Off	SEL HIGH \rightarrow LOW to Comparator Off	2.5 to 4.3		20		ns
t_{ON}	Switch Turn-On Time		2.5 to 4.3		40		ns
t_{OFF}	Switch Turn-Off Time		2.5 to 4.3		15		ns
$t_{J_MIC-S/E}$	Propagation Delay from Comparator Trigger to S/E Output	$J_MIC > REF$ from LOW \rightarrow HIGH $J_MIC < REF$ from HIGH \rightarrow LOW	2.5 to 4.3		10		μs

Power

Symbol	Parameter	Conditions	V_{DD} (V)	$T_A = -40$ to $+85^\circ C$			Unit
				Min.	Typ.	Max.	
PSRR	Power Supply Rejection Ratio	Power Supply Noise at $300mV_{PP}$, Measured 10/90%, $f = 217Hz$	2.8		-100		dB

Physical Dimensions

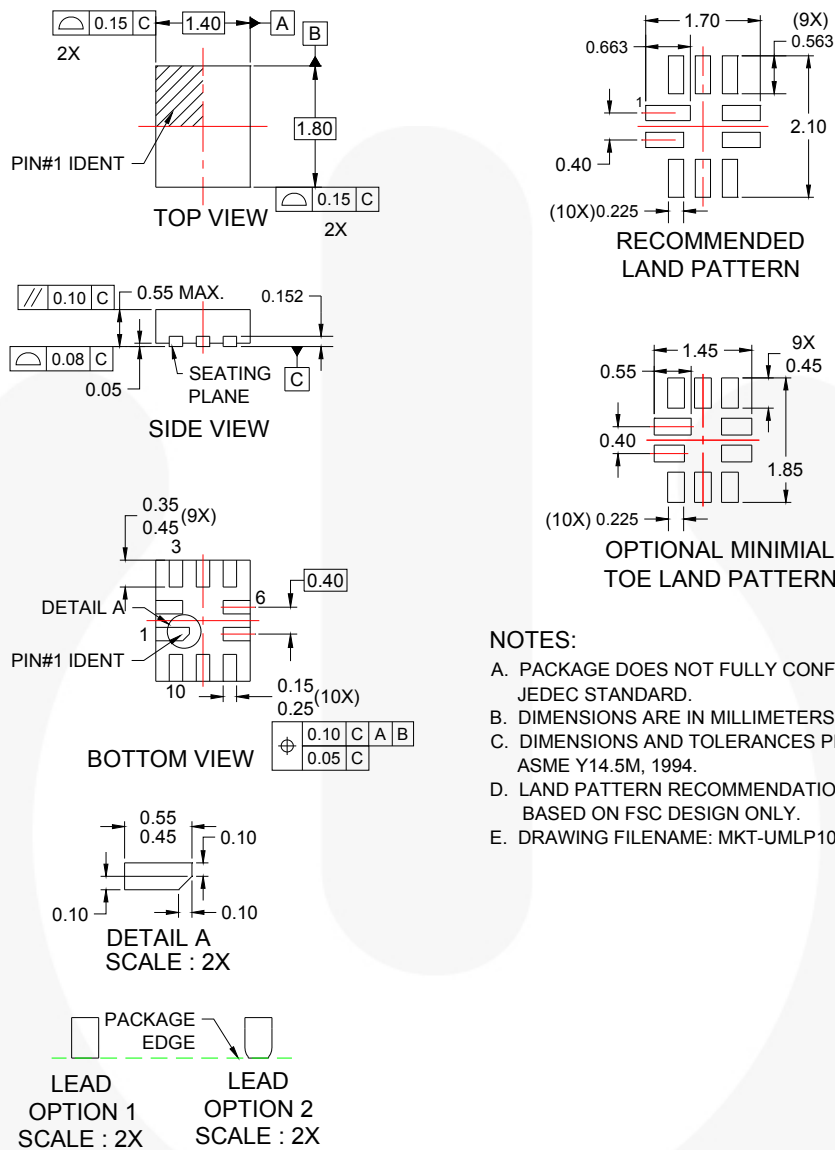

Figure 3. 10-Lead, UMLP Package

Package drawings are provided as a service to customers considering Fairchild components. Drawings may change in any manner without notice. Please note the revision and/or date on the drawing and contact a Fairchild Semiconductor representative to verify or obtain the most recent revision. Package specifications do not expand the terms of Fairchild's worldwide terms and conditions, specifically the warranty therein, which covers Fairchild products.

Always visit Fairchild Semiconductor's online packaging area for the most recent package drawings:
<http://www.fairchildsemi.com/packaging/>





Ordering Information

Part Number	Operating Temperature Range	Top Mark	Package
FSA8029UMX	-40 to +85°C	KS	10-Lead 1.4 x 1.8 x 0.55mm, 0.4mm Pitch, Ultrathin Molded Leadless Package (UMLP)



TRADEMARKS

The following includes registered and unregistered trademarks and service marks, owned by Fairchild Semiconductor and/or its global subsidiaries, and is not intended to be an exhaustive list of all such trademarks.

- | | | | |
|---|--|--|---|
| 2Cool™ | F-PFS™ | PowerTrench® | The Power Franchise® |
| AccuPower™ | FRFET® | PowerXS™ | the power franchise |
| AX-CAP™* | Global Power Resource™ | Programmable Active Droop™ | TinyBoost™ |
| BitSiC™ | GreenBridge™ | QFET® | TinyBuck™ |
| Build it Now™ | Green FPS™ | QS™ | TinyCalc™ |
| CorePLUS™ | Green FPS™ e-Series™ | Quiet Series™ | TinyLogic® |
| CorePOWER™ | Gmax™ | RapidConfigure™ | TINYOPTO™ |
| CROSSVOLT™ | GTO™ |  ™ | TinyPower™ |
| CTL™ | IntelliMAX™ | Saving our world, 1mW/W/kW at a time™ | TinyPWM™ |
| Current Transfer Logic™ | ISOPLANAR™ | SignalWise™ | TinyWire™ |
| DEUXPEED® | Making Small Speakers Sound Louder and Better™ | SmartMax™ | TranSiC™ |
| Dual Cool™ | MegaBuck™ | SMART START™ | TriFault Detect™ |
| EcoSPARK® | MICROCOUPLER™ | Solutions for Your Success™ | TRUECURRENT®* |
| EfficientMax™ | MicroFET™ | SPM® | µSerDes™ |
| ESBC™ | MicroPak™ | STEALTH™ |  ™ |
|  ™ | MicroPak2™ | SuperFET® | UHC® |
| Fairchild® | MillerDrive™ | SuperSOT™-3 | Ultra FRFET™ |
| Fairchild Semiconductor® | MotionMax™ | SuperSOT™-6 | UniFET™ |
| FACT Quiet Series™ | Motion-SPM™ | SuperSOT™-8 | VCX™ |
| FACT® | mWSaver™ | SupreMOS® | VisualMax™ |
| FAST® | OptoHit™ | SyncFET™ | VoltagePlus™ |
| FastvCore™ | OPTOLOGIC® | Sync-Lock™ | XS™ |
| FETBench™ | OPTOPLANAR® |  SYSTEM GENERAL®* | |
| FlashWriter®* | | | |
| FPS™ | | | |

* Trademarks of System General Corporation, used under license by Fairchild Semiconductor.

DISCLAIMER

FAIRCHILD SEMICONDUCTOR RESERVES THE RIGHT TO MAKE CHANGES WITHOUT FURTHER NOTICE TO ANY PRODUCTS HEREIN TO IMPROVE RELIABILITY, FUNCTION, OR DESIGN. FAIRCHILD DOES NOT ASSUME ANY LIABILITY ARISING OUT OF THE APPLICATION OR USE OF ANY PRODUCT OR CIRCUIT DESCRIBED HEREIN; NEITHER DOES IT CONVEY ANY LICENSE UNDER ITS PATENT RIGHTS, NOR THE RIGHTS OF OTHERS. THESE SPECIFICATIONS DO NOT EXPAND THE TERMS OF FAIRCHILD'S WORLDWIDE TERMS AND CONDITIONS, SPECIFICALLY THE WARRANTY THEREIN, WHICH COVERS THESE PRODUCTS.

LIFE SUPPORT POLICY

FAIRCHILD'S PRODUCTS ARE NOT AUTHORIZED FOR USE AS CRITICAL COMPONENTS IN LIFE SUPPORT DEVICES OR SYSTEMS WITHOUT THE EXPRESS WRITTEN APPROVAL OF FAIRCHILD SEMICONDUCTOR CORPORATION.

As used herein:

1. Life support devices or systems are devices or systems which, (a) are intended for surgical implant into the body or (b) support or sustain life, and (c) whose failure to perform when properly used in accordance with instructions for use provided in the labeling, can be reasonably expected to result in a significant injury of the user.
2. A critical component in any component of a life support, device, or system whose failure to perform can be reasonably expected to cause the failure of the life support device or system, or to affect its safety or effectiveness.

ANTI-COUNTERFEITING POLICY

Fairchild Semiconductor Corporation's Anti-Counterfeiting Policy. Fairchild's Anti-Counterfeiting Policy is also stated on our external website, www.fairchildsemi.com, under Sales Support.

Counterfeiting of semiconductor parts is a growing problem in the industry. All manufacturers of semiconductor products are experiencing counterfeiting of their parts. Customers who inadvertently purchase counterfeit parts experience many problems such as loss of brand reputation, substandard performance, failed applications, and increased cost of production and manufacturing delays. Fairchild is taking strong measures to protect ourselves and our customers from the proliferation of counterfeit parts. Fairchild strongly encourages customers to purchase Fairchild parts either directly from Fairchild or from Authorized Fairchild Distributors who are listed by country on our web page cited above. Products customers buy either from Fairchild directly or from Authorized Fairchild Distributors are genuine parts, have full traceability, meet Fairchild's quality standards for handling and storage and provide access to Fairchild's full range of up-to-date technical and product information. Fairchild and our Authorized Distributors will stand behind all warranties and will appropriately address any warranty issues that may arise. Fairchild will not provide any warranty coverage or other assistance for parts bought from Unauthorized Sources. Fairchild is committed to combat this global problem and encourage our customers to do their part in stopping this practice by buying direct or from authorized distributors.

PRODUCT STATUS DEFINITIONS

Definition of Terms

Datasheet Identification	Product Status	Definition
Advance Information	Formative / In Design	Datasheet contains the design specifications for product development. Specifications may change in any manner without notice.
Preliminary	First Production	Datasheet contains preliminary data; supplementary data will be published at a later date. Fairchild Semiconductor reserves the right to make changes at any time without notice to improve design.
No Identification Needed	Full Production	Datasheet contains final specifications. Fairchild Semiconductor reserves the right to make changes at any time without notice to improve the design.
Obsolete	Not In Production	Datasheet contains specifications on a product that is discontinued by Fairchild Semiconductor. The datasheet is for reference information only.

Rev. I61

ON Semiconductor and  are trademarks of Semiconductor Components Industries, LLC dba ON Semiconductor or its subsidiaries in the United States and/or other countries. ON Semiconductor owns the rights to a number of patents, trademarks, copyrights, trade secrets, and other intellectual property. A listing of ON Semiconductor's product/patent coverage may be accessed at www.onsemi.com/site/pdf/Patent-Marking.pdf. ON Semiconductor reserves the right to make changes without further notice to any products herein. ON Semiconductor makes no warranty, representation or guarantee regarding the suitability of its products for any particular purpose, nor does ON Semiconductor assume any liability arising out of the application or use of any product or circuit, and specifically disclaims any and all liability, including without limitation special, consequential or incidental damages. Buyer is responsible for its products and applications using ON Semiconductor products, including compliance with all laws, regulations and safety requirements or standards, regardless of any support or applications information provided by ON Semiconductor. "Typical" parameters which may be provided in ON Semiconductor data sheets and/or specifications can and do vary in different applications and actual performance may vary over time. All operating parameters, including "Typicals" must be validated for each customer application by customer's technical experts. ON Semiconductor does not convey any license under its patent rights nor the rights of others. ON Semiconductor products are not designed, intended, or authorized for use as a critical component in life support systems or any FDA Class 3 medical devices or medical devices with a same or similar classification in a foreign jurisdiction or any devices intended for implantation in the human body. Should Buyer purchase or use ON Semiconductor products for any such unintended or unauthorized application, Buyer shall indemnify and hold ON Semiconductor and its officers, employees, subsidiaries, affiliates, and distributors harmless against all claims, costs, damages, and expenses, and reasonable attorney fees arising out of, directly or indirectly, any claim of personal injury or death associated with such unintended or unauthorized use, even if such claim alleges that ON Semiconductor was negligent regarding the design or manufacture of the part. ON Semiconductor is an Equal Opportunity/Affirmative Action Employer. This literature is subject to all applicable copyright laws and is not for resale in any manner.

PUBLICATION ORDERING INFORMATION

LITERATURE FULFILLMENT:

Literature Distribution Center for ON Semiconductor
19521 E. 32nd Pkwy, Aurora, Colorado 80011 USA
Phone: 303-675-2175 or 800-344-3860 Toll Free USA/Canada
Fax: 303-675-2176 or 800-344-3867 Toll Free USA/Canada
Email: orderlit@onsemi.com

N. American Technical Support: 800-282-9855 Toll Free
USA/Canada
Europe, Middle East and Africa Technical Support:
Phone: 421 33 790 2910
Japan Customer Focus Center
Phone: 81-3-5817-1050

ON Semiconductor Website: www.onsemi.com
Order Literature: <http://www.onsemi.com/orderlit>
For additional information, please contact your local
Sales Representative