



# WLD4FP-8416A130A00

W4

MINIATURE PHOTOELECTRIC SENSORS

**SICK**  
Sensor Intelligence.



Illustration may differ

## Ordering information

Type	Part no.
WLD4FP-8416A130A00	1123749

Other models and accessories → [www.sick.com/W4](http://www.sick.com/W4)



## Detailed technical data

### Features

<b>Functional principle</b>	Photoelectric retro-reflective sensor
<b>Functional principle detail</b>	With minimum distance to reflector (dual lens system)
<b>Sensing range</b>	
Sensing range min.	0 mm
Sensing range max.	4.5 m
Maximum distance range from reflector to sensor (operating reserve 1)	0.015 m ... 4.5 m
Recommended distance range from reflector to sensor (operating reserve 3,75)	0.035 m ... 3.9 m
Reference reflector	Reflector P250
Recommended sensing range for the best performance	0.035 m ... 3.9 m
<b>Polarisation filters</b>	Yes
<b>Emitted beam</b>	
Light source	PinPoint LED
Type of light	Visible red light
Shape of light spot	Point-shaped
Light spot size (distance)	Ø 38 mm (1,000 mm)

Maximum dispersion of the emitted beam around the standardized transmission axis (squint angle)	< +/- 1.5° (at T <sub>a</sub> = +23 °C)
<b>Key LED figures</b>	
Normative reference	EN 62471:2008-09   IEC 62471:2006, modified
LED risk group marking	Free group
Wave length	635 nm
Average service life	100,000 h at T <sub>a</sub> = +25 °C
<b>Adjustment</b>	
Teach-in button	BluePilot: for sensitivity adjustment
IO-Link	For configuring the sensor parameters and Smart Task functions
<b>Indication</b>	
LED blue	BluePilot: Alignment aid
LED green	Operating indicator Static on: power on Flashing: IO-Link mode
LED yellow	Status of received light beam Static on: object not present Static off: object present Flashing: Below the 1.5 function reserve
<b>Special features</b>	Pin2 pre-setting (MF): not active

#### Safety-related parameters

<b>MTTF<sub>D</sub></b>	747 years
<b>DC<sub>avg</sub></b>	0 %
<b>T<sub>M</sub> (mission time)</b>	20 years (EN ISO 13849) Rate of use: 60 %

#### Communication interface

<b>IO-Link</b>	✓, IO-Link V1.1
Data transmission rate	COM2 (38,4 kBaud)
Cycle time	2.3 ms
Process data length	16 Bit
Process data structure	Bit 0 = switching signal Q <sub>L1</sub> Bit 1 = switching signal Q <sub>L2</sub> Bit 2 ... 15 = Current receiver level (live)
VendorID	26
DeviceID HEX	0x8002B9
DeviceID DEC	8389305
Compatible master port type	A
SIO mode support	Yes

#### Electrical data

<b>Supply voltage U<sub>B</sub></b>	10 V DC ... 30 V DC <sup>1)</sup>
<b>Ripple</b>	≤ 5 V <sub>pp</sub>
<b>Usage category</b>	DC-12 (According to EN 60947-5-2)

<sup>1)</sup> Limit values.

<sup>2)</sup> Signal transit time with resistive load in switching mode.

<sup>3)</sup> With light/dark ratio 1:1.

	DC-13 (According to EN 60947-5-2)
<b>Current consumption</b>	≤ 20 mA, without load. At $U_B = 24\text{ V}$
<b>Protection class</b>	III
<b>Digital output</b>	
Number	2 (Complementary)
Type	Push-pull: PNP/NPN
Signal voltage PNP HIGH/LOW	Approx. $U_B - 2.5\text{ V} / 0\text{ V}$
Signal voltage NPN HIGH/LOW	Approx. $U_B / < 2.5\text{ V}$
Output current $I_{max}$ .	≤ 100 mA
Circuit protection outputs	Reverse polarity protected Overcurrent protected Short-circuit protected
Response time	≤ 50 ms <sup>2)</sup>
Repeatability (response time)	150 μs
Switching frequency	20 Hz <sup>3)</sup>
<b>Pin/Wire assignment</b>	
Function of pin 4/black (BK)	Digital output, dark switching, object present → output $\bar{Q}_{L1}$ HIGH; IO-Link communication C
Function of pin 4/black (BK) – detail	The pin 4 function of the sensor can be configured, Additional possible settings via IO-Link
Function of pin 2/white (WH)	Not active
Function of pin 2/white (WH) – detail	The pin 2 function of the sensor can be configured, Additional possible settings via IO-Link

<sup>1)</sup> Limit values.

<sup>2)</sup> Signal transit time with resistive load in switching mode.

<sup>3)</sup> With light/dark ratio 1:1.

## Mechanical data

<b>Housing</b>	Rectangular
<b>Design detail</b>	Flat
<b>Dimensions (W x H x D)</b>	16 mm x 40.1 mm x 12.1 mm
<b>Connection</b>	Cable with M12 male connector, 4-pin, 182 mm
<b>Connection detail</b>	
Deep-freeze property	Do not bend below 0 °C
Conductor size	0.14 mm <sup>2</sup>
Cable diameter	Ø 3.4 mm
Length of cable (L)	140 mm
<b>Material</b>	
Housing	Plastic, VISTAL®
Front screen	Plastic, PMMA
Cable	PVC
Male connector	Plastic, VISTAL®
<b>Weight</b>	Approx. 30 g
<b>Maximum tightening torque of the fixing screws</b>	0.4 Nm

## Ambient data

<b>Enclosure rating</b>	IP66 (EN 60529)
-------------------------	-----------------

	IP67 (EN 60529)
<b>Ambient operating temperature</b>	-40 °C ... +60 °C
<b>Ambient temperature, storage</b>	-40 °C ... +75 °C
<b>Typ. Ambient light immunity</b>	Artificial light: ≤ 50,000 lx Sunlight: ≤ 50,000 lx
<b>Shock resistance</b>	30 g, 11 ms (3 positive and 3 negative shocks along X, Y, Z axes, 18 total shocks (EN60068-2-27))
<b>Vibration resistance</b>	10 Hz ... 1,000 Hz (Amplitude 1 mm, 3 x 30 min (EN60068-2-6))
<b>Air humidity</b>	35 % ... 95 %, Relative humidity (no condensation)
<b>Electromagnetic compatibility (EMC)</b>	EN 60947-5-2
<b>Resistance to cleaning agent</b>	ECOLAB
<b>UL File No.</b>	NRKH.E181493 & NRKH7.E181493

### Smart Task

<b>Smart Task name</b>	Base logics
<b>Logic function</b>	Direct AND OR
<b>Timer function</b>	Deactivated On delay Off delay ON and OFF delay Impulse (one shot)
<b>Inverter</b>	Yes
<b>Switching frequency</b>	SIO Logic: 800 Hz <sup>1)</sup> IOL: 750 Hz <sup>2)</sup>
<b>Response time</b>	SIO Logic: 600 μs <sup>1)</sup> IOL: 650 μs <sup>2)</sup>
<b>Repeatability</b>	SIO Logic: 200 μs <sup>1)</sup> IOL: 250 μs <sup>2)</sup>
<b>Switching signal</b>	
Switching signal Q <sub>L1</sub>	Switching output
Switching signal $\bar{Q}_{L1}$	Switching output

<sup>1)</sup> Use of Smart Task functions without IO-Link communication (SIO mode).

<sup>2)</sup> Use of Smart Task functions with IO-Link communication function.

### Diagnosis

<b>Device temperature</b>	
Measuring range	Very cold, cold, moderate, warm, hot
<b>Device status</b>	Yes
<b>Detailed device status</b>	Yes
<b>Operating hour counter</b>	Yes
<b>Operating hours counter with reset function</b>	Yes
<b>Quality of teach</b>	Yes
<b>Quality of run</b>	Yes, Contamination display

### Classifications

<b>eCI@ss 5.0</b>	27270902
-------------------	----------

<b>eCl@ss 5.1.4</b>	27270902
<b>eCl@ss 6.0</b>	27270902
<b>eCl@ss 6.2</b>	27270902
<b>eCl@ss 7.0</b>	27270902
<b>eCl@ss 8.0</b>	27270902
<b>eCl@ss 8.1</b>	27270902
<b>eCl@ss 9.0</b>	27270902
<b>eCl@ss 10.0</b>	27270902
<b>eCl@ss 11.0</b>	27270902
<b>eCl@ss 12.0</b>	27270904
<b>ETIM 5.0</b>	EC002717
<b>ETIM 6.0</b>	EC002717
<b>ETIM 7.0</b>	EC002717
<b>ETIM 8.0</b>	EC002717
<b>UNSPSC 16.0901</b>	39121528

## Connection type

M12 male connector, 4-pin

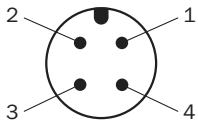

## Connection diagram

Cd-512

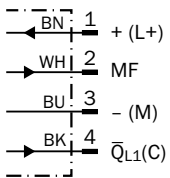

Truth table

Push-pull: PNP/NPN - light switching Q

	Light switching Q (normally closed (upper switch), normally open (lower switch))	
	Object not present → Output HIGH	Object present → Output LOW
Light receive	✓	✗
Light receive indicator	☉	✗
Load resistance to L+	✗	⚠
Load resistance to M	⚠	✗

Push-pull: PNP/NPN – dark switching  $\bar{Q}$

	Dark switching $\bar{Q}$ (normally open (upper switch), normally closed (lower switch))	
	Object not present → Output LOW	Object present → Output HIGH
Light receive	✓	✗
Light receive indicator	☉	✗
Load resistance to L+	⚠	✗
Load resistance to M	✗	⚠

### Characteristic curve

Reflective tape

Operating reserve

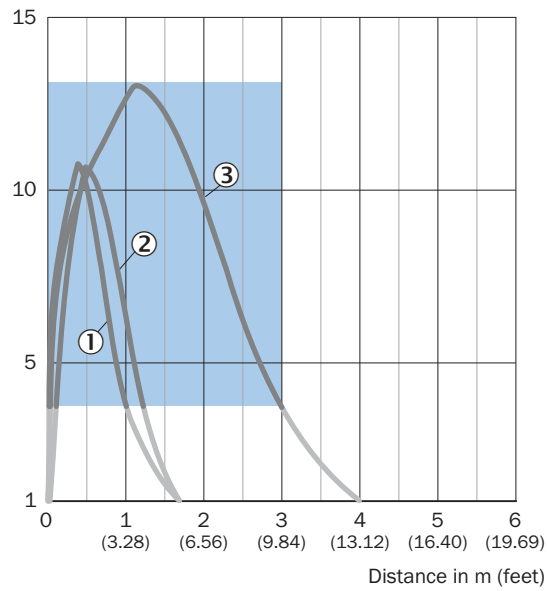

Recommended sensing range for the best performance

- ① Reflective tape REF-DG
- ② Reflective tape REF-IRF-56
- ③ Reflective tape REF-AC1000



Standard reflectors

Operating reserve

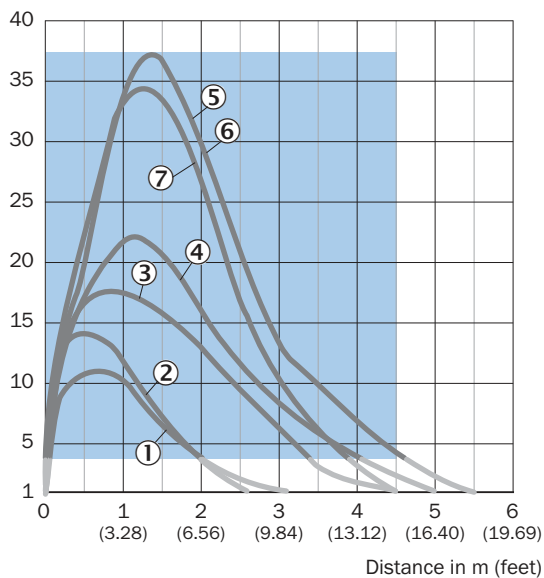

Recommended sensing range for the best performance

- ① Reflector PL22
- ② Reflector PL20A
- ③ Reflector PL30A
- ④ Reflector PL40A
- ⑤ Reflector PL80A
- ⑥ Reflector C110A
- ⑦ Reflector P250

Fine triple reflectors

Operating reserve

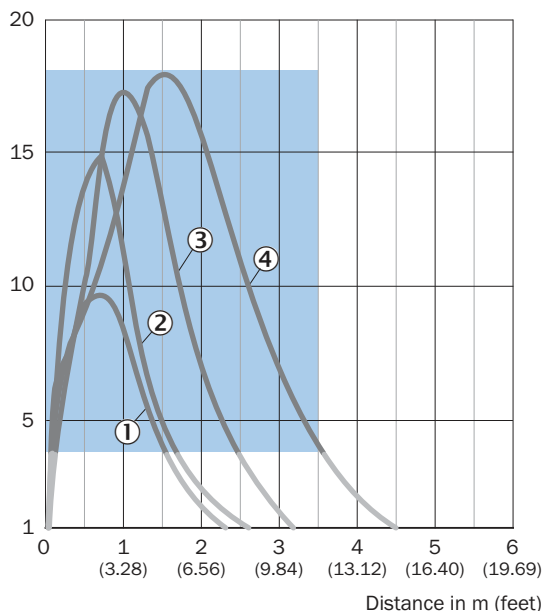

Recommended sensing range for the best performance

- ① PL10FH reflector
- ② PL10F reflector
- ③ Reflector PL20F
- ④ Reflector P250F

Chemical-resistant reflectors

Operating reserve

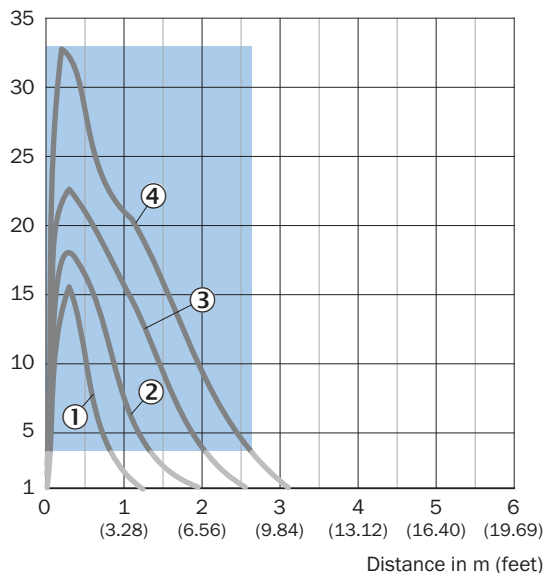

Recommended sensing range for the best performance

- ① PL10F CHEM reflector
- ② Reflector PL20 CHEM
- ③ Reflector P250 CHEM
- ④ Reflector P250H

## Light spot size

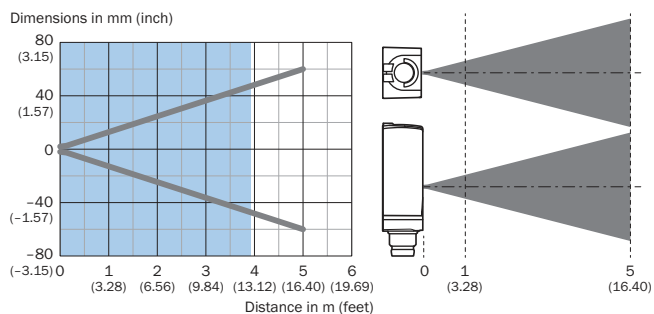

Recommended sensing range for the best performance

## Sensing range diagram

### Standard reflectors

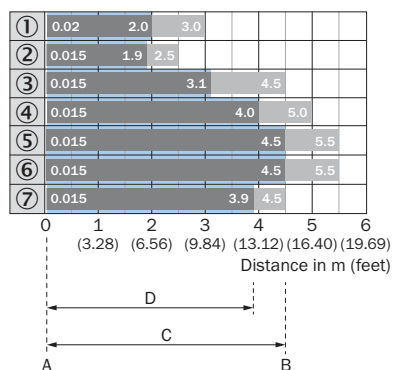

A = Sensing range min. in m

B = Sensing range max. in m

C = Maximum distance range from reflector to sensor (operating reserve 1)

D = Recommended distance range from reflector to sensor (operating reserve 3.75)

Recommended sensing range for the best performance

- ① Reflector PL22
- ② Reflector PL20A
- ③ Reflector PL30A
- ④ Reflector PL40A
- ⑤ Reflector PL80A
- ⑥ Reflector C110A
- ⑦ Reflector P250

### Reflective tape

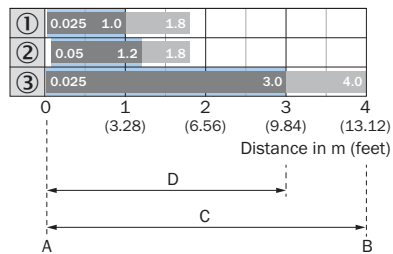

A = Sensing range min. in m  
 B = Sensing range max. in m  
 C = Maximum distance range from reflector to sensor (operating reserve 1)  
 D = Recommended distance range from reflector to sensor (operating reserve 3.75)

Recommended sensing range for the best performance

- ① Reflective tape REF-DG (50 x 50 mm)
- ② Reflective tape REF-IRF-56
- ③ Reflective tape REF-AC1000

### Fine triple reflectors

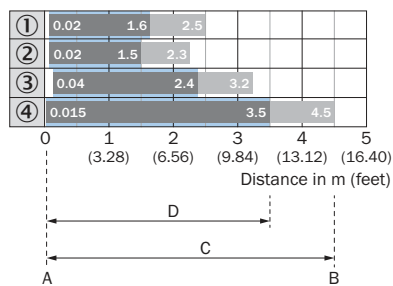

A = Sensing range min. in m  
 B = Sensing range max. in m  
 C = Maximum distance range from reflector to sensor (operating reserve 1)  
 D = Recommended distance range from reflector to sensor (operating reserve 3.75)

Recommended sensing range for the best performance

- ① PL10FH reflector
- ② PL10F reflector
- ③ Reflector PL20F
- ④ Reflector P250F

### Chemical-resistant reflectors

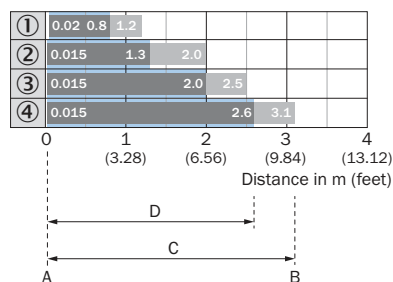

A = Sensing range min. in m  
 B = Sensing range max. in m  
 C = Maximum distance range from reflector to sensor (operating reserve 1)  
 D = Recommended distance range from reflector to sensor (operating reserve 3.75)

Recommended sensing range for the best performance

- ① PL10F CHEM reflector
- ② Reflector PL20 CHEM
- ③ Reflector P250 CHEM
- ④ Reflector P250H

## Adjustments

Display and adjustment elements

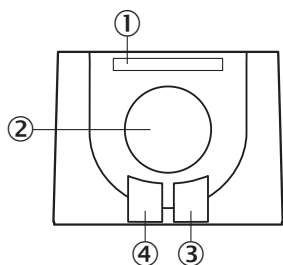

- ① LED blue
- ② Teach-in button
- ③ LED yellow
- ④ LED green

## Dimensional drawing (Dimensions in mm (inch))

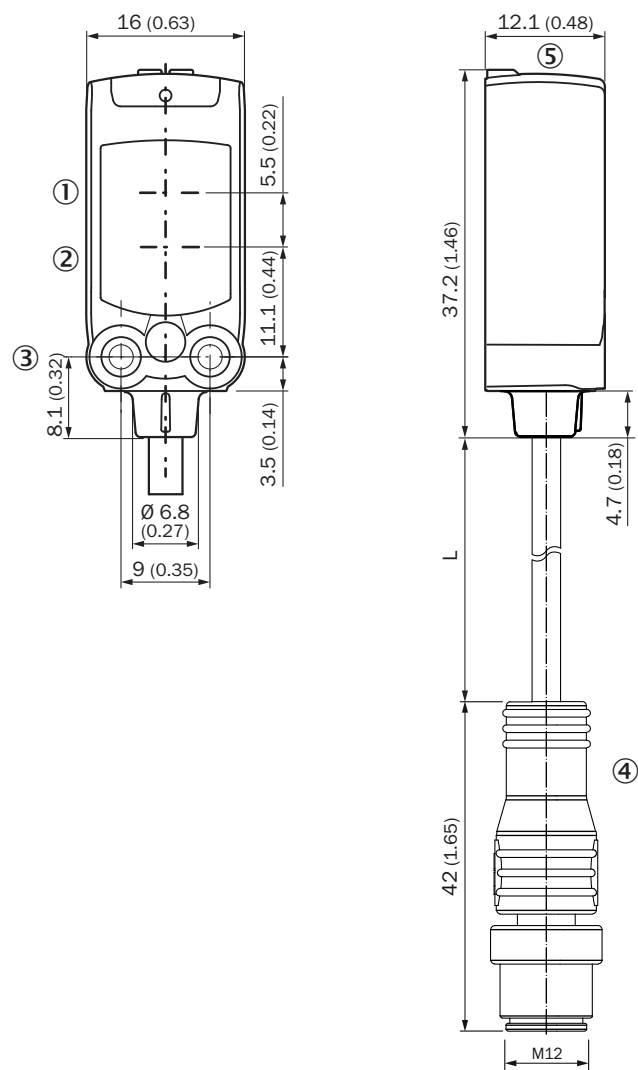





For length of cable (L), see technical data

- ① Center of optical axis, sender
- ② Center of optical axis, receiver
- ③ M3 mounting hole
- ④ Cable with M12 male connector
- ⑤ Display and adjustment elements

### Recommended accessories

Other models and accessories → [www.sick.com/W4](http://www.sick.com/W4)

	Brief description	Type	Part no.
<b>Mounting brackets and plates</b>			
	Mounting bracket for wall mounting, Stainless steel 1.4571, mounting hardware included	BEF-W4-A	2051628
<b>Plug connectors and cables</b>			
	Head A: female connector, M12, 4-pin, straight, A-coded Head B: Flying leads Cable: Sensor/actuator cable, PVC, unshielded, 5 m	YF2A14-050VB3XLEAX	2096235
	Head A: male connector, M12, 4-pin, straight Cable: unshielded	STE-1204-G	6009932
<b>Reflectors</b>			
	Fine triple reflector, screw connection, suitable for laser sensors, 20 mm x 32 mm, PM-MA/ABS, Screw-on, 2 hole mounting	PL10F	5311210

## SICK AT A GLANCE

SICK is one of the leading manufacturers of intelligent sensors and sensor solutions for industrial applications. A unique range of products and services creates the perfect basis for controlling processes securely and efficiently, protecting individuals from accidents and preventing damage to the environment.

We have extensive experience in a wide range of industries and understand their processes and requirements. With intelligent sensors, we can deliver exactly what our customers need. In application centers in Europe, Asia and North America, system solutions are tested and optimized in accordance with customer specifications. All this makes us a reliable supplier and development partner.

Comprehensive services complete our offering: SICK LifeTime Services provide support throughout the machine life cycle and ensure safety and productivity.

For us, that is “Sensor Intelligence.”

## WORLDWIDE PRESENCE:

Contacts and other locations [www.sick.com](http://www.sick.com)