

ICV 2,5/ 8-GF-5,08

Order No.: 1825750

The figure shows a 10-position version of the product

<http://eshop.phoenixcontact.de/phoenix/treeViewClick.do?UID=1825750>

Header, Nominal current: 12 A, Rated voltage (III/2): 320 V, Number of positions: 8, Pitch: 5.08 mm, Color: green, Metal surface: Sn, Assembly: Soldering

Commercial data	
GTIN (EAN)	 4 017918 049911
sales group	E130
Pack	50 pcs.
Customs tariff	85366990
Catalog page information	Page 265 (CC-2009)

Product notesWEEE/RoHS-compliant since:
01/01/2003

<http://www.download.phoenixcontact.com>
Please note that the data given here has been taken from the online catalog. For comprehensive information and data, please refer to the user documentation. The General Terms and Conditions of Use apply to Internet downloads.

Technical data	
Dimensions / positions	
Length	10.2 mm
Pitch	5.08 mm
Dimension a	35.56 mm
Number of positions	8

Pin dimensions	1,2 x 0,5
Hole diameter	1.4 mm

Technical data

Range of articles	ICV 2,5/..-GF
Insulating material group	I
Rated surge voltage (III/3)	4 kV
Rated surge voltage (III/2)	4 kV
Rated surge voltage (II/2)	4 kV
Rated voltage (III/2)	320 V
Rated voltage (II/2)	630 V
Connection in acc. with standard	EN-VDE
Nominal current I_N	12 A
Nominal voltage U_N	320 V
Maximum load current	12 A
Insulating material	PA
Inflammability class acc. to UL 94	V0
Nominal voltage, UL/CUL Use Group B	250 V
Nominal current, UL/CUL Use Group B	12 A
Nominal voltage, UL/CUL Use Group D	300 V
Nominal current, UL/CUL Use Group D	10 A

Certificates / Approvals



Certification

CB, CSA, CUL, GOST, UL, VDE-PZI

Accessories

Item	Designation	Description
Plug/Adapter		
1734634	CP-MSTB	Keying profile, is inserted into the slot on the plug or inverted header, red insulating material
0201744	MPS-MT	Test plugs

0201647	RPS	Reducing plug, Color: gray
---------	-----	----------------------------

Additional products

Item	Designation	Description
General		
1873566	FKIC 2,5/ 8-STF-5,08	Plug component, Nominal current: 12 A, Rated voltage (III/2): 320 V, Number of positions: 8, Pitch: 5.08 mm, Color: green, Metal surface: Sn
1825378	IC 2,5/ 8-STF-5,08	Plug component, Nominal current: 12 A, Rated voltage (III/2): 400 V, Number of positions: 8, Pitch: 5.08 mm, Color: green, Metal surface: Sn
1823448	ICC 2,5/ 8-STZF-5,08	Plug component, Nominal current: 12 A, Rated voltage (III/2): 320 V, Number of positions: 8, Pitch: 5.08 mm, Color: green, Metal surface: Sn, Corresponding male crimp contacts with current [A] and conductor cross section range [mm ²] data: 10A/ICC-MT 0,5-1,0 (3190577); 10A/ICC-MT 0,5-1,0 BA (3190603); 12A/ICC-MT 1,5-2,5 (3190580); 12A/ICC-MT 1,5-2,5 BA (3190593). BA = Bandkontakte

Diagrams/Drawings

Drilling plan/solder pad geometry

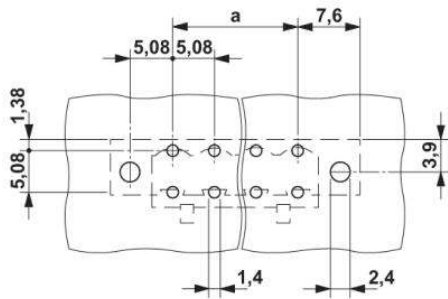

Dimensioned drawing

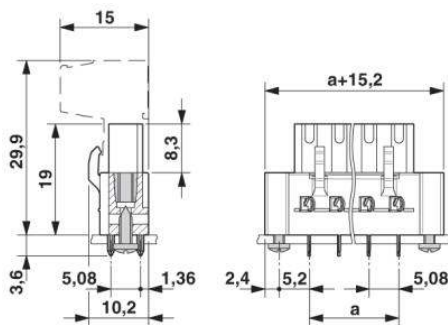

Address

PHOENIX CONTACT Inc., USA
586 Fulling Mill Road
Middletown, PA 17057, USA
Phone (800) 888-7388
Fax (717) 944-1625
<http://www.phoenixcon.com>



© 2011 Phoenix Contact
Technical modifications reserved;