

TPS2202, TPS2202Y

DUAL-SLOT PC CARD POWER-INTERFACE SWITCHES FOR SERIAL PCMCIA CONTROLLERS

SLVS103B – DECEMBER 1994 – REVISED JANUARY 2001

- Fully Integrated V_{CC} and V_{pp} Switching for Dual-Slot PC Card™ Interface
- Saves PCMCIA Controller I/O Leads by Utilizing 3-Lead Serial Interface
- Meets PCMCIA Standards
- Internal Charge Pump (No External Capacitors Required) – 12-V Supply Can Be Disabled Except for Flash Programming
- Short-Circuit and Thermal Protection
- Space-Saving 30-Pin SSOP(DB) Package
- For 3.3-V, 5-V and 12-V PC Cards
- Power Saving $I_{DD} = 83 \mu A$ Typ, $I_Q = 1 \mu A$
- Low $r_{DS(on)}$ (160-m Ω V_{CC} Switch)
- Break-Before-Make Switching
- ESD Protection Up to 2 kV Per Mil-STD-883C, Method 3015

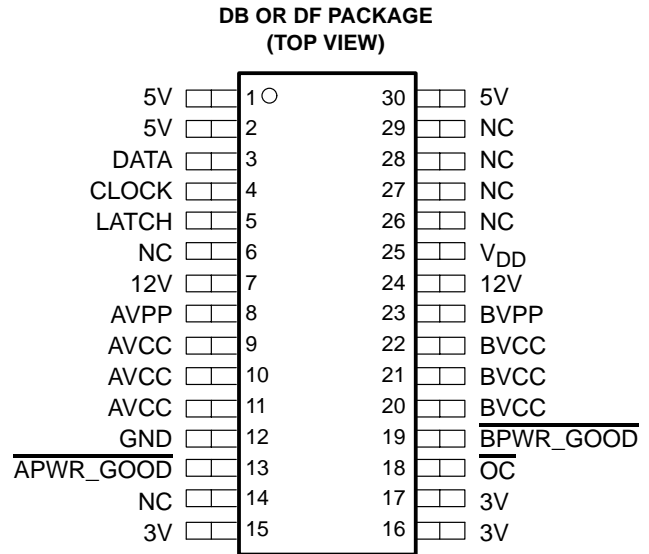

NC – No internal connection

description

The TPS2202 PC Card (PCMCIA) power-interface switch provides an integrated power-management solution for two PC Cards. All of the discrete power MOSFETs, a logic section, current limiting, thermal protection, and power-good reporting for PC Card control are combined on a single integrated circuit, using Texas Instruments LinBiCMOS™ process. The circuit allows the distribution of 3-V, 5-V, and/or 12-V card power by means of a reduced I/O serial interface. The current-limiting feature eliminates the need for fuses, which reduces component count and improves reliability; current-limit reporting can help the user isolate a system fault to a bad card.

The TPS2202 maximizes battery life by using an internal charge pump to generate its own switch-drive voltage. Therefore, the 12-V supply can be powered down and only brought out of standby when flash memory needs to be written to or erased. End equipment for the TPS2202 includes notebook computers, desktop computers, personal digital assistants (PDAs), digital cameras, handterminals, and bar-code scanners.

typical PC-card power-distribution application

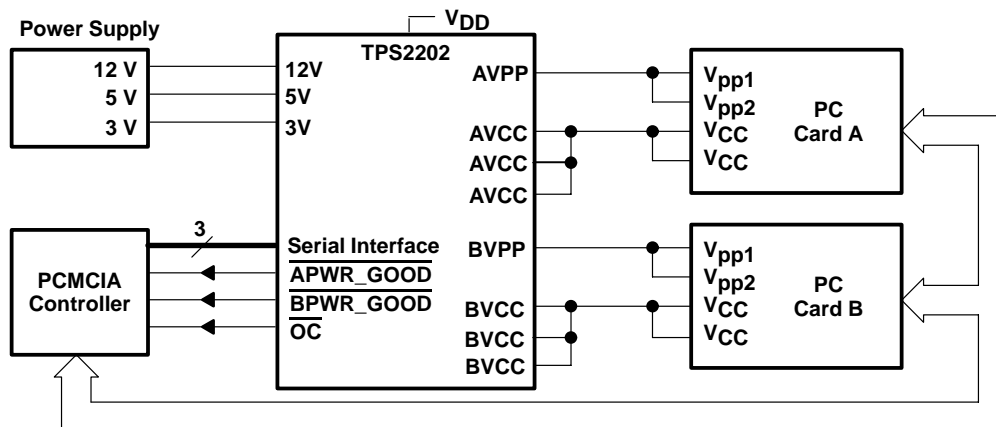

Please be aware that an important notice concerning availability, standard warranty, and use in critical applications of Texas Instruments semiconductor products and disclaimers thereto appears at the end of this data sheet.

PC Card is a trademark of PCMCIA (Personal Computer Memory Card International Association).
LinBiCMOS is a trademark of Texas Instruments.

PRODUCTION DATA information is current as of publication date. Products conform to specifications per the terms of Texas Instruments standard warranty. Production processing does not necessarily include testing of all parameters.



Copyright © 2001, Texas Instruments Incorporated

TPS2202, TPS2202Y
DUAL-SLOT PC CARD POWER-INTERFACE SWITCHES
FOR SERIAL PCMCIA CONTROLLERS

SLVS103B – DECEMBER 1994 – REVISED JANUARY 2001

AVAILABLE OPTIONS

T _J	PACKAGED DEVICES		CHIP FORM (Y)
	SHINK SMALL-OUTLINE (DB) [†]	SMALL-OUTLINE (DF) [†]	
-40°C to 150°C	TPS2202IDBR	TPS2202IDFR	TPS2202Y

[†] The DB and DF packages are only available taped and reeled, indicated by the R suffix on the device type.

Terminal Functions

TERMINAL NAME	NO.	I/O	DESCRIPTION
3V	15, 16, 17	I	3-V V _{CC} input for card power
5V	1, 2, 30	I	5-V V _{CC} input for card power
12V	7, 24	I	12-V V _{pp} input for card power
AVCC	9, 10, 11	O	Switched output that delivers 0 V, 3.3 V, 5 V, or high impedance
AVPP	8	O	Switched output that delivers 0 V, 3.3 V, 5 V, 12 V, or high impedance
APWR_GOOD	13	O	Logic-level power-ready output that stays low as long as AVPP is within limits.
BVCC	20, 21, 22	O	Switched output that delivers 0 V, 3.3 V, 5 V, or high impedance
BVPP	23	O	Switched output that delivers 0 V, 3.3 V, 5 V, 12 V, or high impedance
BPWR_GOOD	19	O	Logic-level power-ready output that stays low as long as BVPP is within limits.
CLOCK	4	I	Logic-level clock for serial data word
DATA	3	I	Logic-level serial data word
GND	12		Ground
LATCH	5	I	Logic-level latch for serial data word
NC	6, 14, 26, 27, 28, 29		No internal connection
OC	18	O	Logic-level overcurrent reporting output that goes low when an overcurrent condition exists.
VDD	25		5-V power to chip



TPS2202, TPS2202Y DUAL-SLOT PC CARD POWER-INTERFACE SWITCHES FOR SERIAL PCMCIA CONTROLLERS

SLVS103B – DECEMBER 1994 – REVISED JANUARY 2001

TPS2202Y chip information

This chip, when properly assembled, displays characteristics similar to the TPS2202. Thermal compression or ultrasonic bonding may be used on the doped aluminum bonding pads. The chips may be mounted with conductive epoxy or a gold-silicon preform.

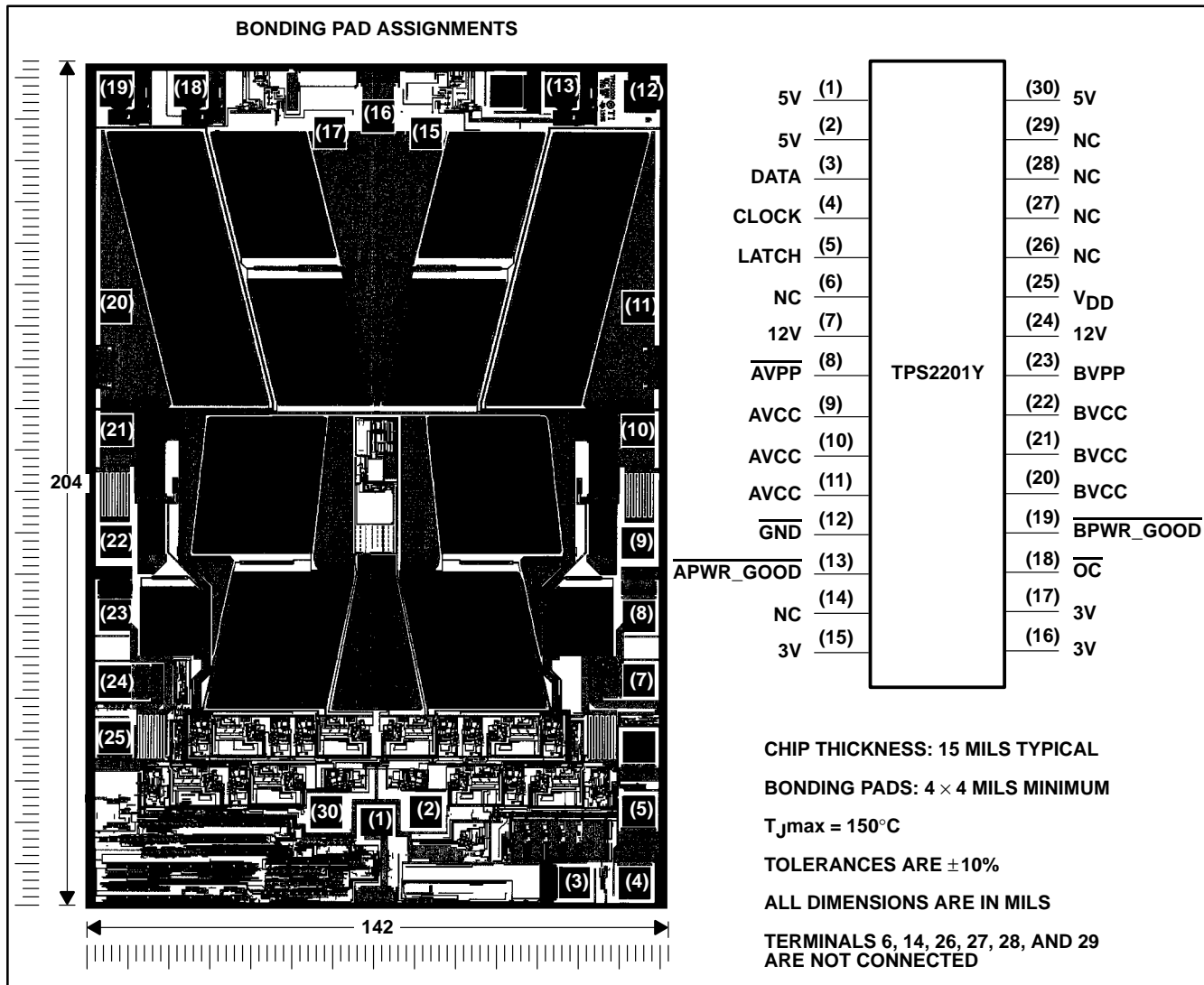

TPS2202, TPS2202Y DUAL-SLOT PC CARD POWER-INTERFACE SWITCHES FOR SERIAL PCMCIA CONTROLLERS

SLVS103B – DECEMBER 1994 – REVISED JANUARY 2001

absolute maximum ratings over operating free-air temperature (unless otherwise noted)†

Supply voltage range, V_{DD}	–0.3 V to 7 V
Input voltage range for card power: $V_{I(5V)}$	–0.3 V to 7 V
$V_{I(3V)}$	–0.3 V to $V_{I(5V)}$
$V_{I(12V)}$	–0.3 V to 14 V
Logic input voltage	–0.3 V to 7 V
Continuous total power dissipation	See Dissipation Rating Table
Output current (each card): $I_{O(xVCC)}$	internally limited
$I_{O(xVPP)}$	internally limited
Operating virtual junction temperature range, T_J	–40°C to 150°C
Operating free-air temperature range, T_A	–40°C to 85°C
Storage temperature range, T_{stg}	–55°C to 150°C
Lead temperature 1,6 mm (1/16 inch) from case for 10 seconds	260°C

† Stresses beyond those listed under “absolute maximum ratings” may cause permanent damage to the device. These are stress ratings only, and functional operation of the device at these or any other conditions beyond those indicated under “recommended operating conditions” is not implied. Exposure to absolute-maximum-rated conditions for extended periods may affect device reliability.

DISSIPATION RATING TABLE

PACKAGE	$T_A \leq 25^\circ\text{C}$ POWER RATING	DERATING FACTOR‡ ABOVE $T_A = 25^\circ\text{C}$	$T_A = 70^\circ\text{C}$ POWER RATING	$T_A = 85^\circ\text{C}$ POWER RATING
DB	1024 mW	8.2 mW/°C	655 mW	532 mW
DF	1158 mW	9.26 mW/°C	741 mW	602 mW

‡ Maximum values are calculated using a derating factor based on $R_{\theta JA} = 108^\circ\text{C}/\text{W}$ for the package. These devices are mounted on an FR4 board with no special thermal considerations.

recommended operating conditions

	MIN	MAX	UNIT	
Supply voltage, V_{DD}	4.75	5.25	V	
Input voltage range, V_I	$V_{I(5V)}$	0	5.25	V
	$V_{I(3V)}$	0	$V_{I(5V)}$ §	V
	$V_{I(12V)}$	0	13.5	V
Output current, I_O	$I_{O(xVCC)}$ at 25°C	1	A	
	$I_{O(xVPP)}$ at 25°C	150	mA	
Clock frequency, f_{clock}	0	2.5	MHz	
Operating virtual junction temperature, T_J	–40	125	°C	

§ $V_{I(3V)}$ should not be taken above $V_{I(5V)}$.



TPS2202, TPS2202Y
DUAL-SLOT PC CARD POWER-INTERFACE SWITCHES
FOR SERIAL PCMCIA CONTROLLERS

SLVS103B – DECEMBER 1994 – REVISED JANUARY 2001

electrical characteristics, $T_A = 25^\circ\text{C}$, $V_{DD} = 5\text{ V}$ (unless otherwise noted)

dc characteristics

PARAMETER		TEST CONDITIONS	TPS2202			UNIT
			MIN	TYP	MAX	
Switch resistances [†]	5 V to xVCC				160	m Ω
	3 V to xVCC				225	
	5 V to xVPP				6	Ω
	3 V to xVPP				6	
	12 V to xVPP				1	
Clamp low voltage		I_{pp} at 10 mA			0.8	V
Clamp low voltage		I_{CC} at 10 mA			0.8	V
Leakage current	I_{pp} High-impedance state	$T_A = 25^\circ\text{C}$		1	10	μA
		$T_A = 85^\circ\text{C}$			50	
	I_{CC} High-impedance state	$T_A = 25^\circ\text{C}$		1	10	
		$T_A = 85^\circ\text{C}$			50	
Input current	I_{DD}	$V_O(\text{AVCC}) = V_O(\text{BVCC}) = 5\text{ V}$, $V_O(\text{AVPP}) = V_O(\text{BVPP}) = 12\text{ V}$		83	150	μA
	I_{DD} in shutdown	$V_O(\text{BVCC}) = V_O(\text{AVCC}) = V_O(\text{AVPP}) = V_O(\text{BVPP}) = \text{Hi-Z}$			1	μA
Power-ready threshold, $\overline{\text{PWR_GOOD}}$			10.72	11.05	11.4	V
Power-ready hysteresis, $\overline{\text{PWR_GOOD}}$ (12-V mode)				50		mV
Short-circuit output-current limit	$I_O(\text{xVCC})$	$T_J = 85^\circ\text{C}$, Output powered up into a short to GND	0.75	1.3	1.9	A
	$I_O(\text{xVPP})$		120	200	400	mA

[†] Pulse-testing techniques maintain junction temperature close to ambient temperature; thermal effects must be taken into account separately.

switching characteristics[‡]

PARAMETER		TEST CONDITIONS	TPS2202			UNIT
			MIN	TYP	MAX	
t_r Output rise time		$V_O(\text{xVCC})$		1.2		ms
		$V_O(\text{xVPP})$		5		
t_f Output fall time		$V_O(\text{xVCC})$		10		ms
		$V_O(\text{xVPP})$		14		
t_{pd} Propagation delay (see Figure 1§)	LATCH \uparrow to $V_O(\text{xVPP})$	t_{on}		5.8		ms
		t_{off}		18		
	LATCH \uparrow to xVCC (3 V)	t_{on}		5.8		ms
		t_{off}		28		
	LATCH \uparrow to xVCC (5 V)	t_{on}		4		ms
		t_{off}		30		

[‡] Refer to Parameter Measurement Information

[§] Propagation delays are with $C_L = 100\ \mu\text{F}$.

TPS2202, TPS2202Y
DUAL-SLOT PC CARD POWER-INTERFACE SWITCHES
FOR SERIAL PCMCIA CONTROLLERS

SLVS103B – DECEMBER 1994 – REVISED JANUARY 2001

electrical characteristics, $T_A = 25^\circ\text{C}$, $V_{DD} = 5\text{ V}$ (unless otherwise noted) (continued)

logic section

PARAMETER	TEST CONDITIONS	TPS2202		UNIT
		MIN	MAX	
Logic input current			1	μA
Logic input high level		2.7		V
Logic input low level			0.8	V
Logic output high level	$I_O = 1\text{ mA}$	$V_{DD} - 0.4$		V
Logic output low level		0.4		V

dc characteristics

PARAMETER		TEST CONDITIONS	TPS2202Y			UNIT
			MIN	TYP	MAX	
Leakage current	I_{pp} High-impedance state		1			μA
	I_{CC} High-impedance state		1			
Input current	I_{DD}	$V_O(\text{AVCC}) = V_O(\text{BVCC}) = 5\text{ V}$, $V_O(\text{AVPP}) = V_O(\text{BVPP}) = 12\text{ V}$	83			μA
Power-ready threshold, $\overline{\text{PWR_GOOD}}$			11.05			V
Power-ready hysteresis, $\overline{\text{PWR_GOOD}}$ (12-V mode)			50			mV

switching characteristics†

PARAMETER		TEST CONDITIONS	TPS2202Y			UNIT
			MIN	TYP	MAX	
t_r Output rise time		$V_O(\text{xVCC})$	1.2			ms
		$V_O(\text{xVPP})$	5			
t_f Output fall time		$V_O(\text{xVCC})$	10			ms
		$V_O(\text{xVPP})$	14			
t_{pd} Propagation delay (see Figure 1‡)	LATCH \uparrow to $V_O(\text{xVPP})$	t_{on}	5.8			ms
		t_{off}	18			
	LATCH \uparrow to xVCC	t_{on}	5.8			ms
		t_{off}	28			
	LATCH \uparrow to xVCC	t_{on}	4			ms
		t_{off}	30			

† Refer to Parameter Measurement Information

‡ Propagation delays are with $C_L = 100\ \mu\text{F}$.



PARAMETER MEASUREMENT INFORMATION

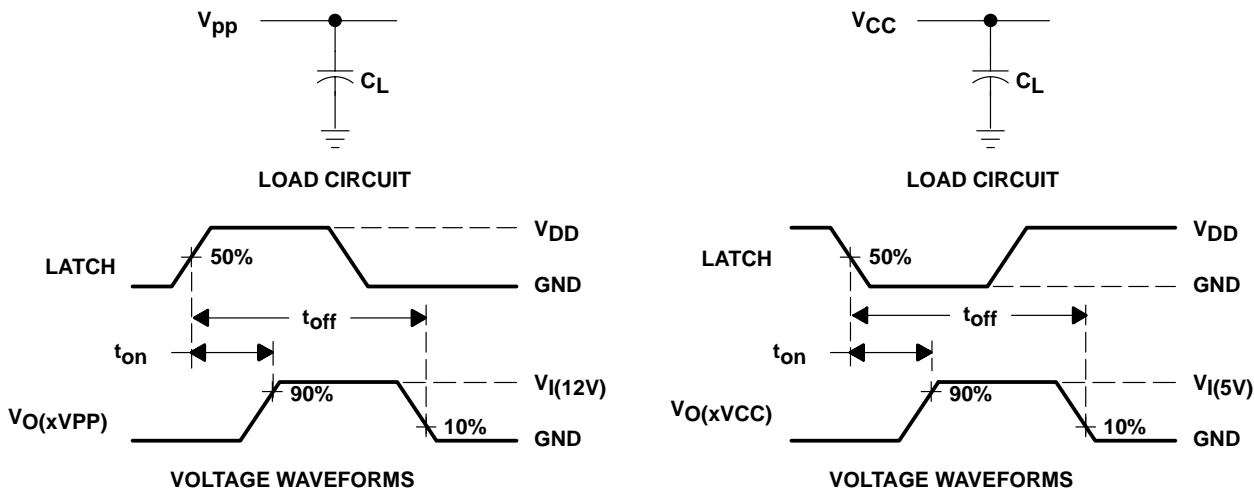
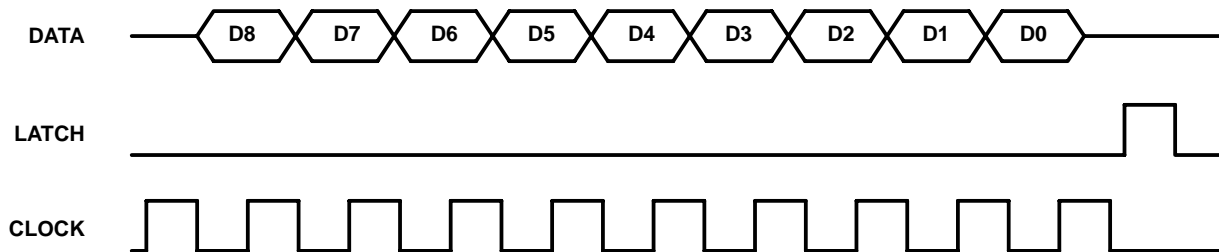

Figure 1. Test Circuits and Voltage Waveforms

Table of Timing Diagrams

	FIGURE
Serial-Interface Timing	2
xVCC Propagation Delay and Rise Times With 1- μ F Load, 3-V Switch	3
xVCC Propagation Delay and Fall Times With 1- μ F Load, 3-V Switch	4
xVCC Propagation Delay and Rise Times With 100- μ F Load, 3-V Switch	5
xVCC Propagation Delay and Fall Times With 100- μ F Load, 3-V Switch	6
xVCC Propagation Delay and Rise Times With 1- μ F Load, 5-V Switch	7
xVCC Propagation Delay and Fall Times With 1- μ F Load, 5-V Switch	8
xVCC Propagation Delay and Rise Times With 100- μ F Load, 5-V Switch	9
xVCC Propagation Delay and Fall Times With 100- μ F Load, 5-V Switch	10
xVPP Propagation Delay and Rise Times With 1- μ F Load, 12-V Switch	11
xVPP Propagation Delay and Fall Times With 1- μ F Load, 12-V Switch	12
xVPP Propagation Delay and Rise Times With 100- μ F Load, 12-V Switch	13
xVPP Propagation Delay and Fall Times With 100- μ F Load, 12-V Switch	14



NOTE A: Data is clocked in on the a positive leading edge of the clock. The latch should occur before next positive leading edge of the clock. For definition of D0–D8, see control logic table.

Figure 2. Serial-Interface Timing

TPS2202, TPS2202Y
DUAL-SLOT PC CARD POWER-INTERFACE SWITCHES
FOR SERIAL PCMCIA CONTROLLERS

SLVS103B – DECEMBER 1994 – REVISED JANUARY 2001

PARAMETER MEASUREMENT INFORMATION

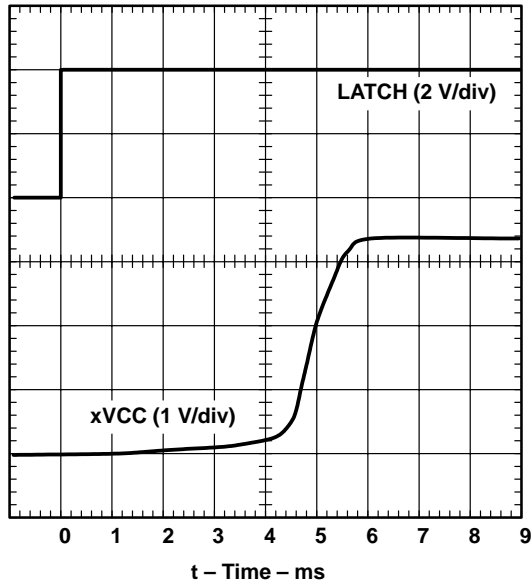

Figure 3. xVCC Propagation Delay and Rise Times With 1- μ F Load, 3-V Switch

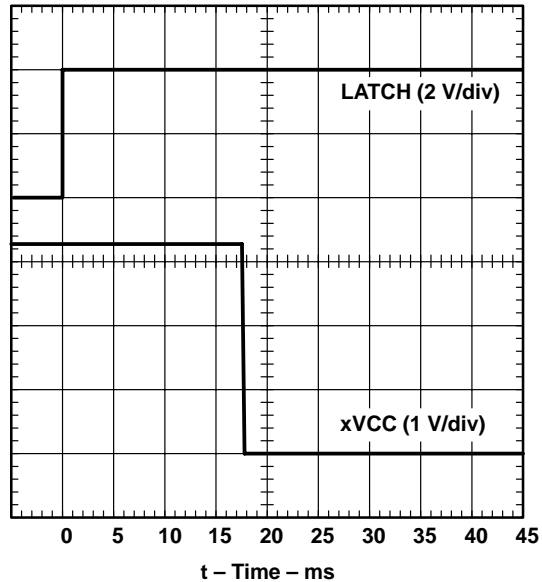

Figure 4. xVCC Propagation Delay and Fall Times With 1- μ F Load, 3-V Switch

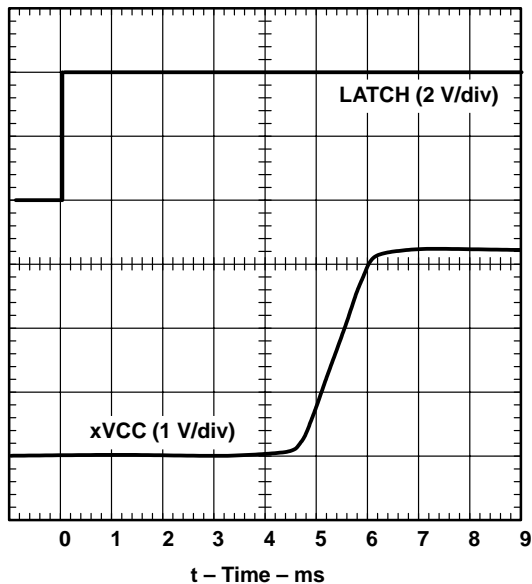

Figure 5. xVCC Propagation Delay and Rise Times With 100- μ F Load, 3-V Switch

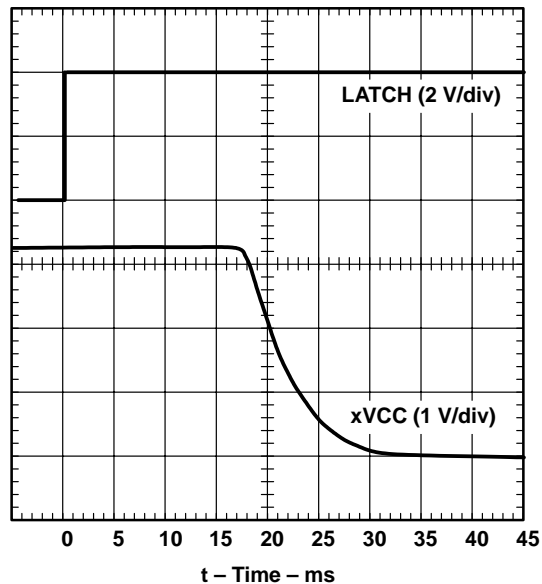

Figure 6. xVCC Propagation Delay and Fall Times With 100- μ F Load, 3-V Switch

PARAMETER MEASUREMENT INFORMATION

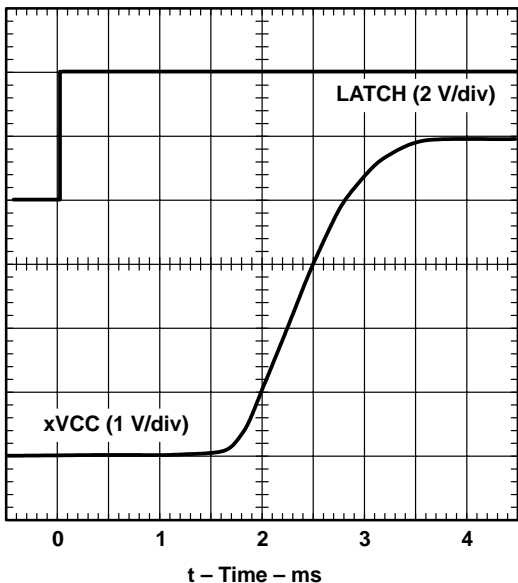

Figure 7. xVCC Propagation Delay and Rise Times With 1- μ F Load, 5-V Switch

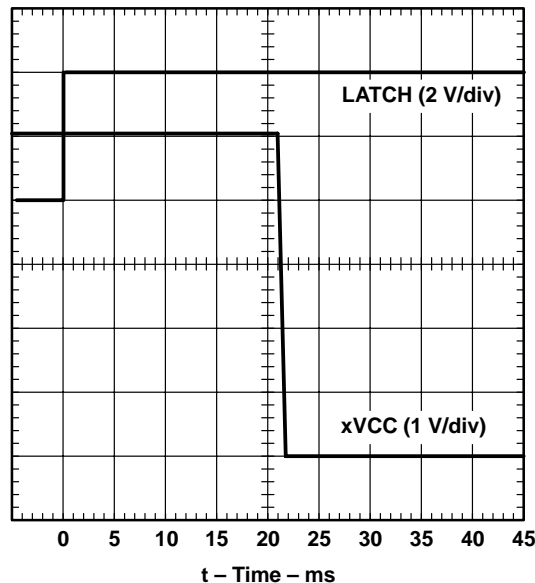

Figure 8. xVCC Propagation Delay and Fall Times With 1- μ F Load, 5-V Switch

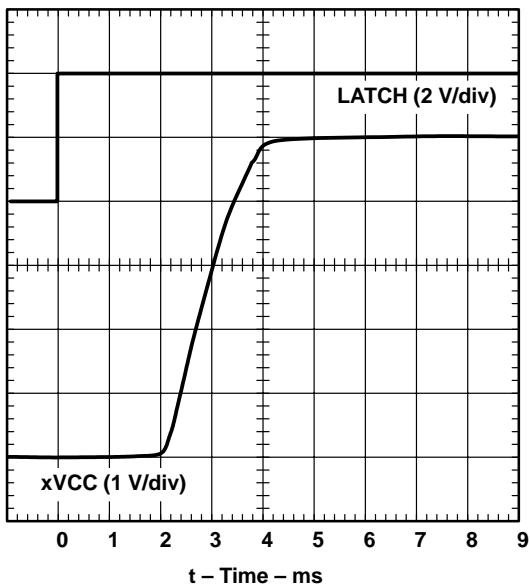

Figure 9. xVCC Propagation Delay and Rise Times With 100- μ F Load, 5-V Switch

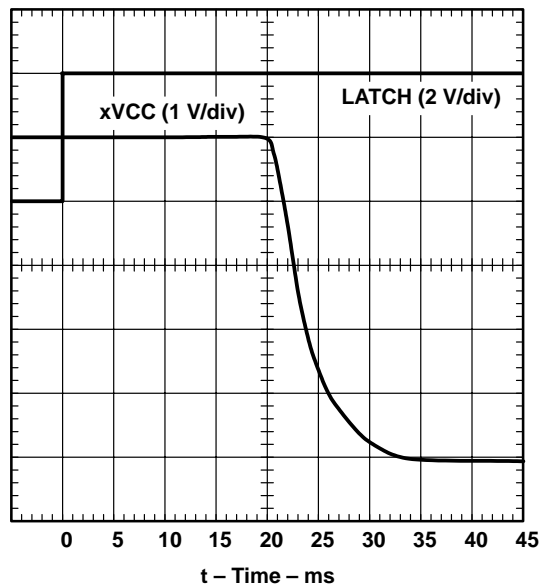

Figure 10. xVCC Propagation Delay and Fall Times With 100- μ F Load, 5-V Switch

PARAMETER MEASUREMENT INFORMATION

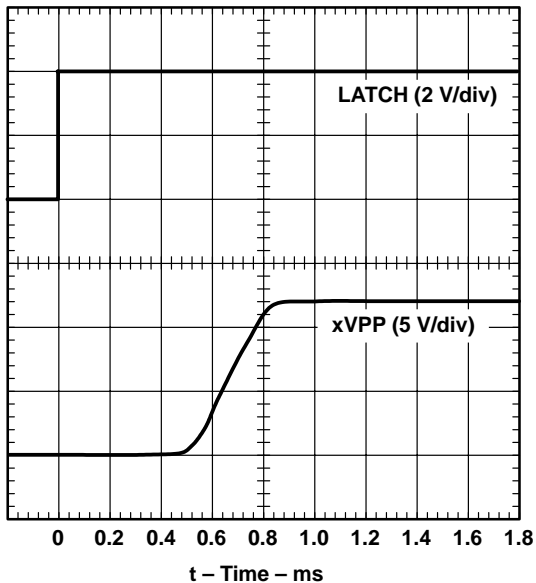

Figure 11. xVPP Propagation Delay and Rise Times With 1- μ F Load, 12-V Switch

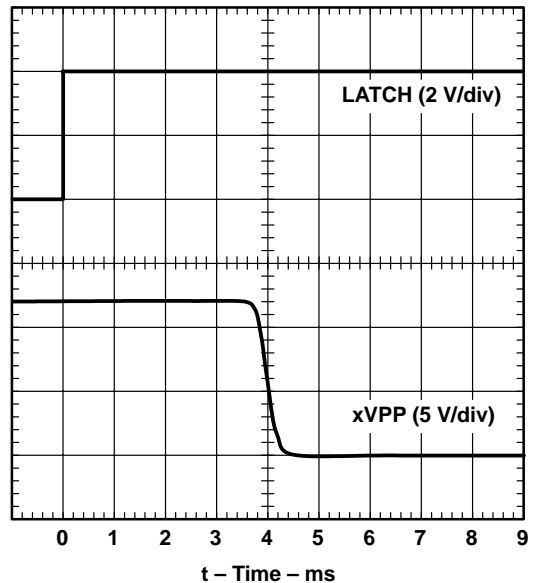

Figure 12. xVPP Propagation Delay and Fall Times With 1- μ F Load, 12-V Switch

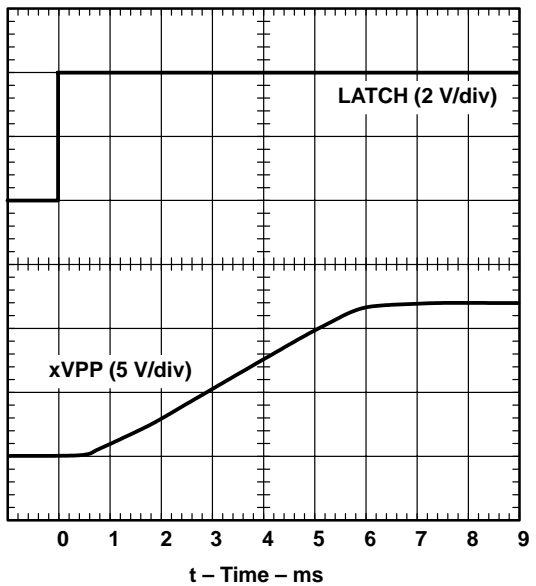

Figure 13. xVPP Propagation Delay and Rise Times With 100- μ F Load, 12-V Switch

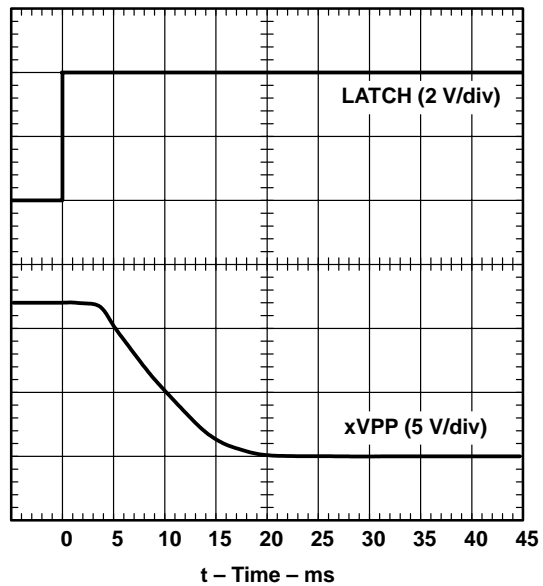

Figure 14. xVPP Propagation Delay and Fall Times With 100- μ F Load, 12-V Switch

TPS2202, TPS2202Y
DUAL-SLOT PC CARD POWER-INTERFACE SWITCHES
FOR SERIAL PCMCIA CONTROLLERS

SLVS103B – DECEMBER 1994 – REVISED JANUARY 2001

TYPICAL CHARACTERISTICS†

Table of Graphs

			FIGURE
I_{DD}	Supply current	vs Junction temperature	15
$r_{DS(on)}$	Static drain-source on-state resistance, 3-V switch	vs Junction temperature	16
$r_{DS(on)}$	Static drain-source on-state resistance, 5-V switch	vs Junction temperature	17
$r_{DS(on)}$	Static drain-source on-state resistance, 12-V switch	vs Junction temperature	18
$V_{O(xVCC)}$	Output voltage, 5-V switch	vs Output current	19
$V_{O(xVCC)}$	Output voltage, 3-V switch	vs Output current	20
xV_{PP}	Output voltage, V_{pp} switch	vs Output current	21
$I_{SC(xVCC)}$	Short-circuit current, 5-V switch	vs Junction temperature	22
$I_{SC(xVPP)}$	Short-circuit current, 12-V switch	vs Junction temperature	23

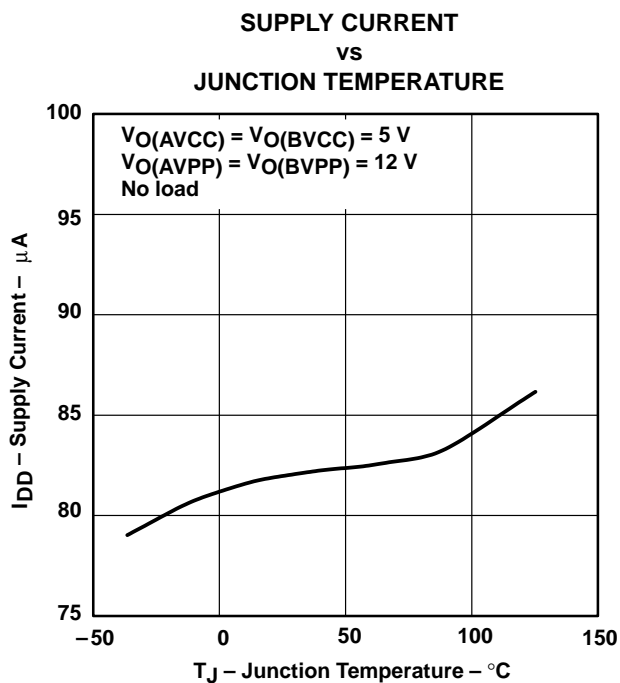

† t = pulse tested

TPS2202, TPS2202Y DUAL-SLOT PC CARD POWER-INTERFACE SWITCHES FOR SERIAL PCMCIA CONTROLLERS

SLVS103B – DECEMBER 1994 – REVISED JANUARY 2001

TYPICAL CHARACTERISTICS†

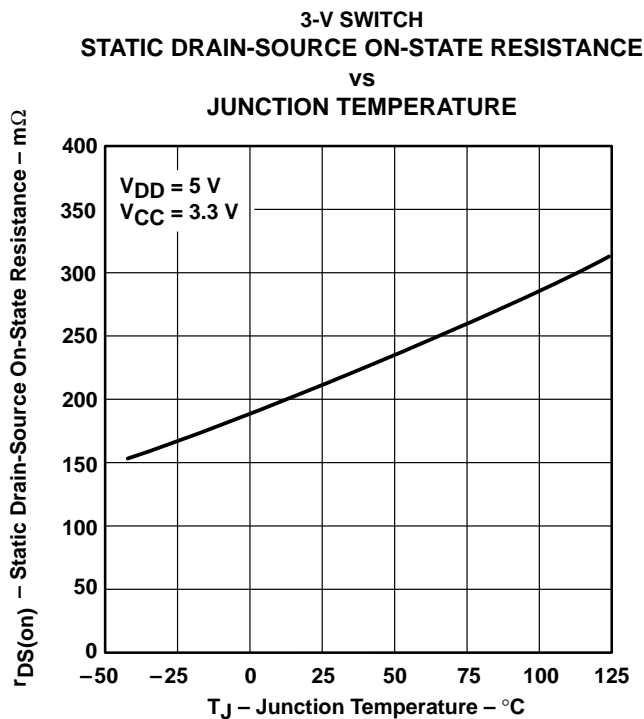

Figure 16

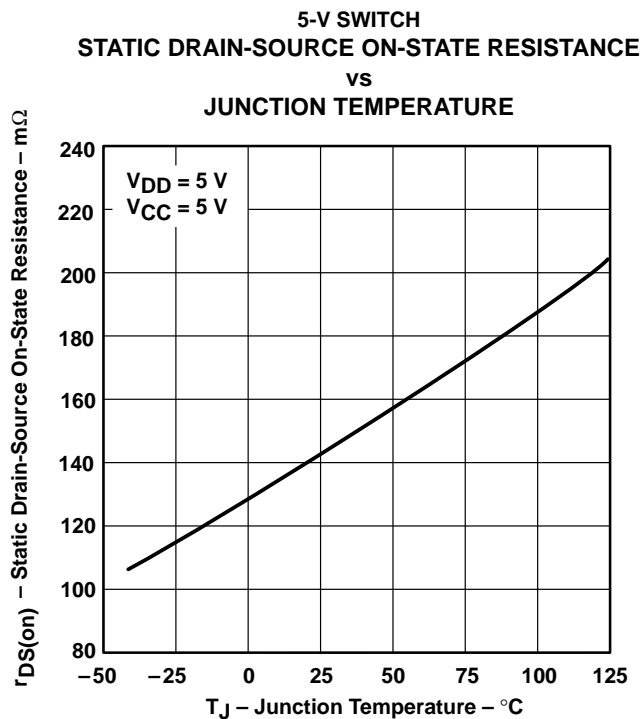

Figure 17

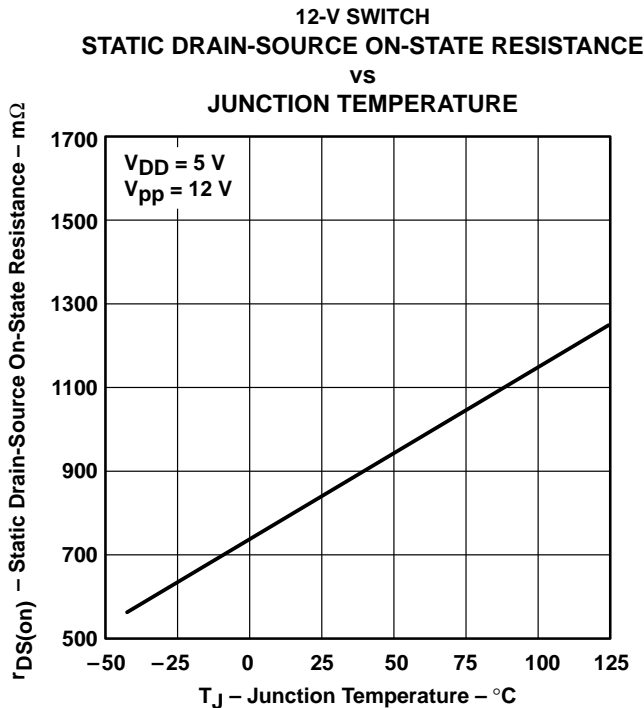

Figure 18

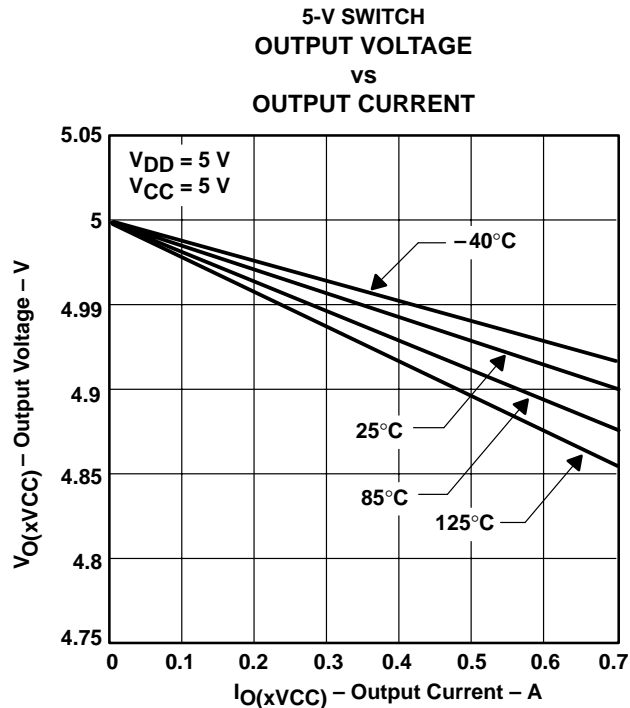

Figure 19

† t = pulse tested



TYPICAL CHARACTERISTICS†

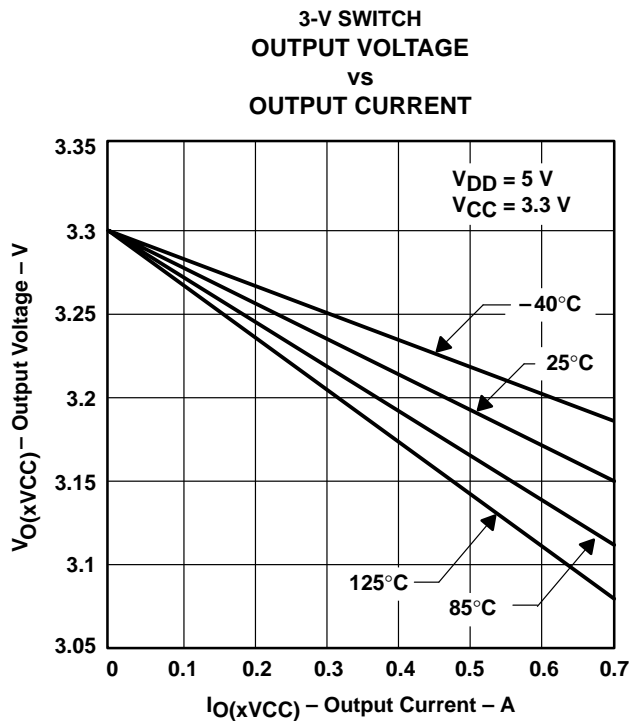

Figure 20

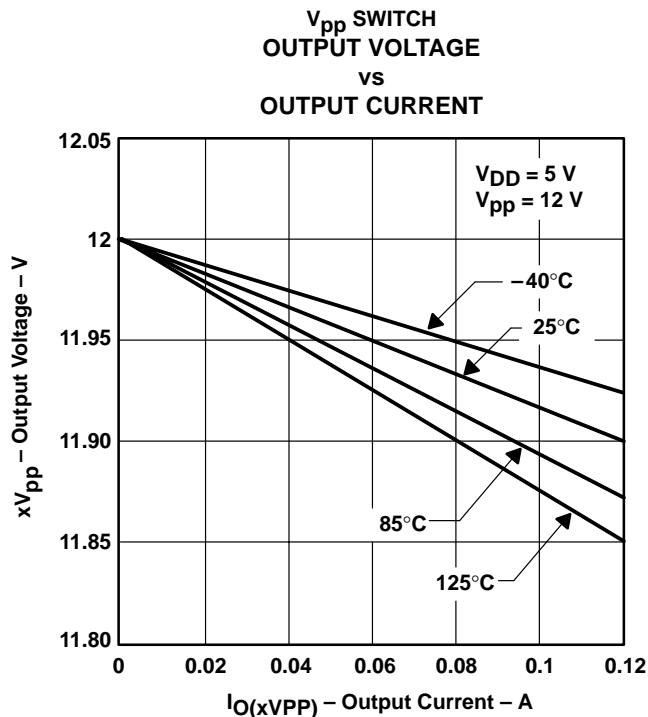

Figure 21

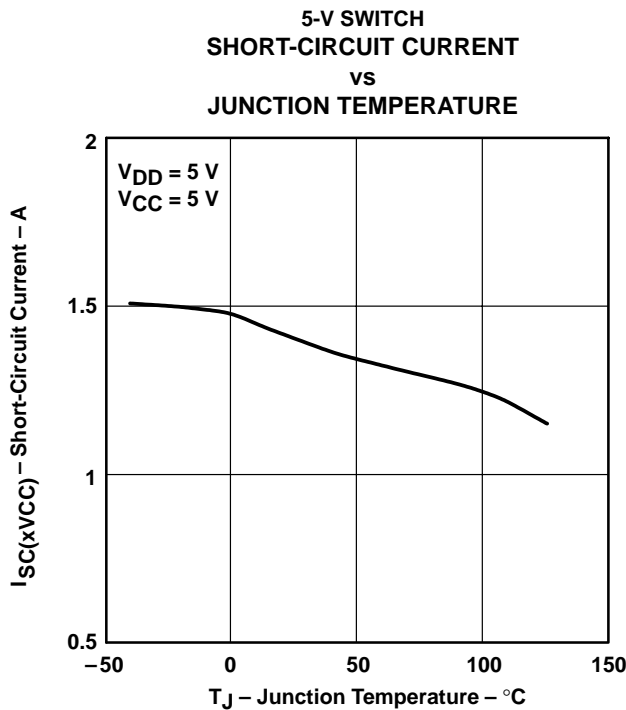

Figure 22

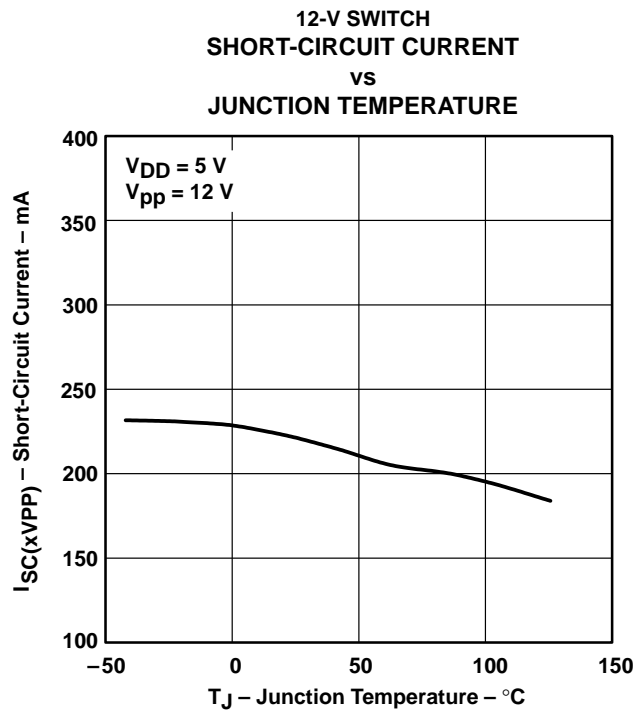

Figure 23

† t = pulse tested

TPS2202, TPS2202Y DUAL-SLOT PC CARD POWER-INTERFACE SWITCHES FOR SERIAL PCMCIA CONTROLLERS

SLVS103B – DECEMBER 1994 – REVISED JANUARY 2001

APPLICATION INFORMATION

overview

PC Cards were initially introduced as a means to add EEPROM (flash memory) to portable computers with limited on-board memory. The idea of add-in cards quickly took hold: modems, wireless LANs, GPS systems, multimedia, and hard-disk versions were soon available. As the number of PC Card applications grew, the engineering community quickly recognized the need for a standard to ensure compatibility across platforms. To this end, the PCMCIA (Personal Computer Memory Card International Association) was established and was comprised of members from leading computer, software, PC card, and semiconductor manufacturers. One key goal was to realize the concept of *plug-and-play*, cards and hosts from different vendors should be compatible and able to communicate with one another transparently.

PC Card power specification

System compatibility also means power compatibility. The most current set of specifications (PC Card Standard) set forth by the PCMCIA committee states that power is to be transferred between the host and the card through eight of the PC Card connector's 68 pins. This power interface consists of two V_{CC} , two V_{pp} , and four ground pins. Multiple V_{CC} and ground pins minimize connector-pin and line resistance. The two V_{pp} pins were originally specified as separate signals but are commonly tied together in the host to form a single node to minimize voltage losses. Card primary power is supplied through the V_{CC} pins; flash-memory programming and erase voltage is supplied through the V_{pp} pins. As each pin is rated to 0.5 A, V_{CC} and V_{pp} can theoretically supply up to 1 A, assuming equal pin resistance and no pin failure. A conservative design would limit current to 500 mA. Some applications, however, require higher V_{CC} currents; disk drives, for example, may need as much as 750-mA peak current to create the initial torque necessary to spin up the platter. V_{pp} currents, on the other hand, are defined by flash-memory programming requirements, typically under 120 mA.

future power trends

The 1-A physical-pin current alluded to in the PC Card specification has caused some host-system engineers to believe they are required to deliver 1 A within the voltage tolerance of the card. Future applications, such as RF cards, could use the extra power for their radio transmitters. The 5 W needed for these cards will require very robust power supplies and special cooling considerations. The limited number of host sockets that will be able to support them makes the market for these high-powered PC Cards uncertain. The vast majority of the cards require less than 600 mA continuous current and the trend is towards even lower-powered PC Cards that will assure compatibility with a greater number of host systems. Recognizing the need for power derating, an adhoc committee of the PCMCIA is currently working to limit the amount of steady-state dc current to the PC Card to something less than the currently implied 1 A. If a system is designed to support 1 A, then the switch $r_{DS(on)}$, power supply requirements, and PC Card cooling need to be carefully considered.

designing around 1-A delivery

Delivering 1 A means minimizing voltage (and power) losses across the PC Card power interface, which requires that designers trade off switch resistance and the cost associated with large-die (low $r_{DS(on)}$) MOSFET transistors. The PC Card standard requires that 5 V $\pm 5\%$, or 3.3 V ± 0.3 V be supplied to the card. The approximate 10% tolerance for the 3.3-V supply makes the 3.3-V $r_{DS(on)}$ less critical than the 5-V switch. A conservative approach is to allow 2% for voltage-regulator tolerance and 1% for etch- and terminal-resistance drops, which leaves 2% (100 mV) voltage drop for the 5-V switch, and at least 6% (198 mV) for the 3.3-V switch.

Calculating the $r_{DS(on)}$ necessary to support a 100 mV or 198 mV switch loss, using $R = E/I$ and setting $I = 1$ A, the 5-V and 3.3-V switches would need to be 100 m Ω and 198 m Ω respectively. One solution would be to pay for a more expensive switch with lower $r_{DS(on)}$. A second, less expensive approach is to increase the headroom of the power supply—for example, to increase the 5-V supply 1.5% or to 5.075 $\pm 2\%$. Working through the numbers once more, the 2% for the regulator plus 1% for etch and terminal losses leaves 97% or 4.923 V.



APPLICATION INFORMATION

designing around 1-A delivery (continued)

The allowable voltage loss across the power distribution switch is now 4.923 V minus 4.750 V or 173 mV. Therefore, a switch with 173 m Ω or less could deliver 1 A or greater. Setting the power supply high is a common practice for delivering voltages to allow for system switch, connector, and etch losses and has a minimal effect on overall battery life. In the example above, setting the power supply 1.5% high would only decrease a 3-hour battery life by approximately 2.7 minutes, trivial when compared with the decrease in battery life when running a 5-W PC Card.

heat dissipation

A greater concern in delivering 1 A or 5 W is the ability of the host to dissipate the heat generated by the PC Card. For desktop computers the solution is simpler: locate the PC Card cage such that it receives convection cooling from the forced air of the fan. Notebooks and other handheld equipment are not be able to rely on convection, but must rely on conduction of heat away from the PC Card through the rails into the card cage. This is difficult because PC Card/card cage heat transfer is very poor. A typical design scenario would require the PC Card to be held at 60°C maximum with the host platform operating as high as 50°C. Preliminary testing reveals that a PC Card can have a 20°C rise, exceeding the 10°C differential in the example, when dissipating less than 2 W of continuous power. The 60°C temperature was chosen because it is the maximum operating temperature allowable by PC Card specification. Power handling requirements and temperature rises are topics of concern and are currently being addressed by the PCMCIA committee.

overcurrent and overtemperature protection

PC Cards are inherently subject to damage that can result from mishandling. Host systems require protection against short-circuited cards that could lead to power supply or PCB-trace damage. Even systems sufficiently robust to withstand a short circuit would still undergo rapid battery discharge into the damaged PC Card, resulting in the rather sudden and unacceptable loss of system power. This can be particularly frustrating to the consumer who has already experienced problems with shortened battery life due to improper Nicad conditioning or memory effect. Most hosts include fuses for protection. The reliability of fused systems is poor, though, as blown fuses require troubleshooting and repair, usually by the manufacturer. The TPS2202 takes a two-pronged approach to overcurrent protection. First, instead of fuses, sense FETs monitor each of the power outputs. Excessive current generates an error signal that linearly limits the output current, preventing host damage or failure. Sense FETs, unlike sense resistors or polyfuses, have the added advantage that they do not add to the series resistance of the switch and thus produce no additional voltage losses. Second, when an overcurrent condition is detected, the TPS2202 asserts a signal at \overline{OC} that can be monitored by the microprocessor to initiate diagnostics and/or send the user a warning message. In the event that an overcurrent condition persists, causing the IC to exceed its maximum junction temperature, thermal-protection circuitry engages, shutting down all power outputs until the device cools to within a safe operating region.

12-V supply not required

Most PC Card switches use the externally supplied 12-V V_{pp} power for switch-gate drive and other chip functions, requiring that it be present at all times. The TPS2202 offers considerable power savings by using an internal charge pump to generate the required higher voltages from the 5-V V_{DD} supply; therefore, the external 12-V supply can be disabled except when needed for flash-memory functions, thereby extending battery lifetime. Additional power savings are realized by the TPS2202 during a software shutdown, in which quiescent current drops to a maximum of 1 μ A.

voltage transitioning requirement

PC Cards, like portables, are migrating from 5 V to 3.3 V to minimize power consumption, optimize board space, and increase logic speeds. The TPS2202 is designed to meet all combinations of power delivery as currently defined in the PCMCIA standard. The latest protocol accommodates mixed 3.3-V/5-V systems by first powering the card with 5 V, then polling it to determine its 3.3-V compatibility. The PCMCIA specification requires that the

TPS2202, TPS2202Y DUAL-SLOT PC CARD POWER-INTERFACE SWITCHES FOR SERIAL PCMCIA CONTROLLERS

SLVS103B – DECEMBER 1994 – REVISED JANUARY 2001

APPLICATION INFORMATION

voltage transitioning requirement (continued)

capacitors on 3.3-V compatible cards be discharged to below 0.8 V before applying 3.3-V power. This ensures that sensitive 3.3-V circuitry is not subjected to any residual 5-V charge and functions as a power reset. The TPS2202 offers a selectable V_{CC} and V_{PP} ground state, in accordance with PCMCIA 3.3-V/5-V switching specifications, to fully discharge the card capacitors while switching between V_{CC} voltages.

output ground switches

Several PCMCIA power-distribution switches on the market do not have an active-grounding FET switch. These devices do not meet the PC Card specification requiring a discharge of V_{CC} within 100 ms. PC Card resistance can not be relied on to provide a discharge path for voltages stored on PC Card capacitance because of possible high-impedance isolation by power-management schemes. A method commonly shown to alleviate this problem is to add to the switch output an external 100-k Ω resistor in parallel with the PC Card. Considering that this is the only discharge path to ground, a timing analysis will reveal that the RC time constant delays the required discharge time to over 2 seconds. The only way to ensure timing compatibility with PC Card standards is to use a power-distribution switch that has an internal ground switch, like that of the TPS22xx family, or add an external ground FET to each of the output lines with the control logic necessary to select it.

In summary, the TPS2202 is a complete single-chip dual-slot PC Card power interface. It meets all currently defined PCMCIA specifications for power delivery in 5-V, 3.3-V, and mixed systems, and offers a serial controller interface. The TPS2202 offers functionality, power savings, overcurrent and thermal protection, and fault reporting in one 30-pin SSOP surface-mount package for maximum value added to new portable designs.

power-supply considerations

The TPS2202 has multiple terminals for each of its 3.3-V, 5-V, and 12-V power inputs and for the switched V_{CC} outputs. Any individual terminal can conduct the rated input or output current. Unless all terminals are connected in parallel, the series resistance is significantly higher than that specified, resulting in increased voltage drops and lost power. Both 12 V inputs must be connected for proper V_{PP} switching; it is recommended that all input and output power terminals be paralleled for optimum operation. The V_{DD} input lead must be connected to the 5V input leads.

Although the TPS2202 is fairly immune to power input fluctuations and noise, it is generally considered good design practice to bypass power supplies typically with a 1- μ F electrolytic or tantalum capacitor paralleled by a 0.047- μ F to 0.1- μ F ceramic capacitor. It is strongly recommended that the switched V_{CC} and V_{PP} outputs be bypassed with a 0.1- μ F or larger capacitor; doing so improves the immunity of the TPS2202 to electrostatic discharge (ESD). Care should be taken to minimize the inductance of PCB traces between the TPS2202 and the load. High switching currents can produce large negative-voltage transients, which forward biases substrate diodes, resulting in unpredictable performance.

The TPS2202, unlike other PC Card power-interface switches, does not use the 12-V power supply for switching or other chip functions. Instead, an internal charge pump generates the necessary voltage from V_{DD} , allowing the 12-V input supply to be shut down except when the V_{PP} programming or erase voltage is needed. Careful system design making use of this feature reduces power consumption and extends battery lifetime.

The 3.3-V power input should not be taken higher than the 5-V input. Doing so, though nondestructive, results in high current flow into the device, and could result in abnormal operation. In any case, this occurrence indicates a malfunction of one input voltage or both, which should be investigated.

Similarly, no terminal should be taken below -0.3 V; forward biasing the parasitic-substrate diode results in substrate currents and unpredictable performance.



POST OFFICE BOX 655303 • DALLAS, TEXAS 75265

APPLICATION INFORMATION

overcurrent and thermal protection

The TPS2202 uses sense FETs to check for overcurrent conditions in each of the V_{CC} and V_{pp} outputs. Unlike sense resistors or polyfuses, these FETs do not add to the series resistance of the switch; therefore, voltage and power losses are reduced. Overcurrent sensing is applied to each output separately. When an overcurrent condition is detected, only the power output affected is limited; all other power outputs continue to function normally. The \overline{OC} indicator, normally a logic high, is a logic low when any overcurrent condition is detected, providing for initiation of system diagnostics and/or sending a warning message to the user.

During power up, the TPS2202 controls the rise time of the V_{CC} and V_{pp} outputs and limits the current into a faulty card or connector. If a short circuit is applied after power is established (e.g., hot insertion of a bad card), current is initially limited only by the impedance between the short and the power supply. In extreme cases, as much as 10 A to 15 A may flow into the short before the current limiting of the TPS2202 engages. If the V_{CC} or V_{pp} outputs are driven below ground, the TPS2202 may latch nondestructively in an off state. Cycling power reestablishes normal operation.

Overcurrent limiting for the V_{CC} outputs is designed to engage if powered up into a short in the range of 0.75 A to 1.9 A, typically at about 1.3 A; the V_{pp} outputs limit from 120 mA to 400 mA, typically around 200 mA. The protection circuitry acts by linearly limiting the current passing through the switch, rather than initiating a full shutdown of the supply. Shutdown occurs only during thermal limiting.

Thermal limiting prevents destruction of the IC from overheating when the package power-dissipation ratings are exceeded. Thermal limiting, disables all power outputs (both A and B slots) until the device has cooled.

calculating junction temperature

The switch resistance, $r_{DS(on)}$, is dependent on the junction temperature, T_J , of the die. The junction temperature is dependent on both $r_{DS(on)}$ and the current through the switch. To calculate T_J , first find $r_{DS(on)}$ from Figures 16, 17, and 18 using an initial temperature estimate about 50°C above ambient. Then calculate the power dissipation for each switch, using the formula:

$$P_D = r_{DS(on)} \cdot I^2$$

Next, sum the power dissipation and calculate the junction temperature:

$$T_J = \left(\sum P_D \cdot R_{\theta JA} \right) + T_A, \quad R_{\theta JA} = 108^\circ\text{C/W}$$

Compare the calculated junction temperature with the initial temperature estimate. If they are not within a few degrees of each other, reiterate using the calculated temperature as the initial estimate.

logic input and outputs

The serial interface consists of DATA, CLOCK, and LATCH leads. The data is clocked in on the positive leading edge of the clock (see Figure 2). The 9-bit (D0 through D8) serial data word is loaded during the positive edge of the latch signal. The latch signal should occur before the next positive leading edge of the clock.

The shutdown bit of the data word places all V_{CC} and V_{pp} outputs in a high-impedance state and reduces chip quiescent current to 1 μA to conserve battery power.

The TPS2202 serial interface is designed to be compatible with serial-interface PCMCIA controllers and current PCMCIA and JEIDA standards.

An overcurrent output (\overline{OC}) is provided to indicate an overcurrent condition in any of the V_{CC} or V_{pp} outputs, as previously discussed.

TPS2202, TPS2202Y
DUAL-SLOT PC CARD POWER-INTERFACE SWITCHES
FOR SERIAL PCMCIA CONTROLLERS

SLVS103B – DECEMBER 1994 – REVISED JANUARY 2001

APPLICATION INFORMATION

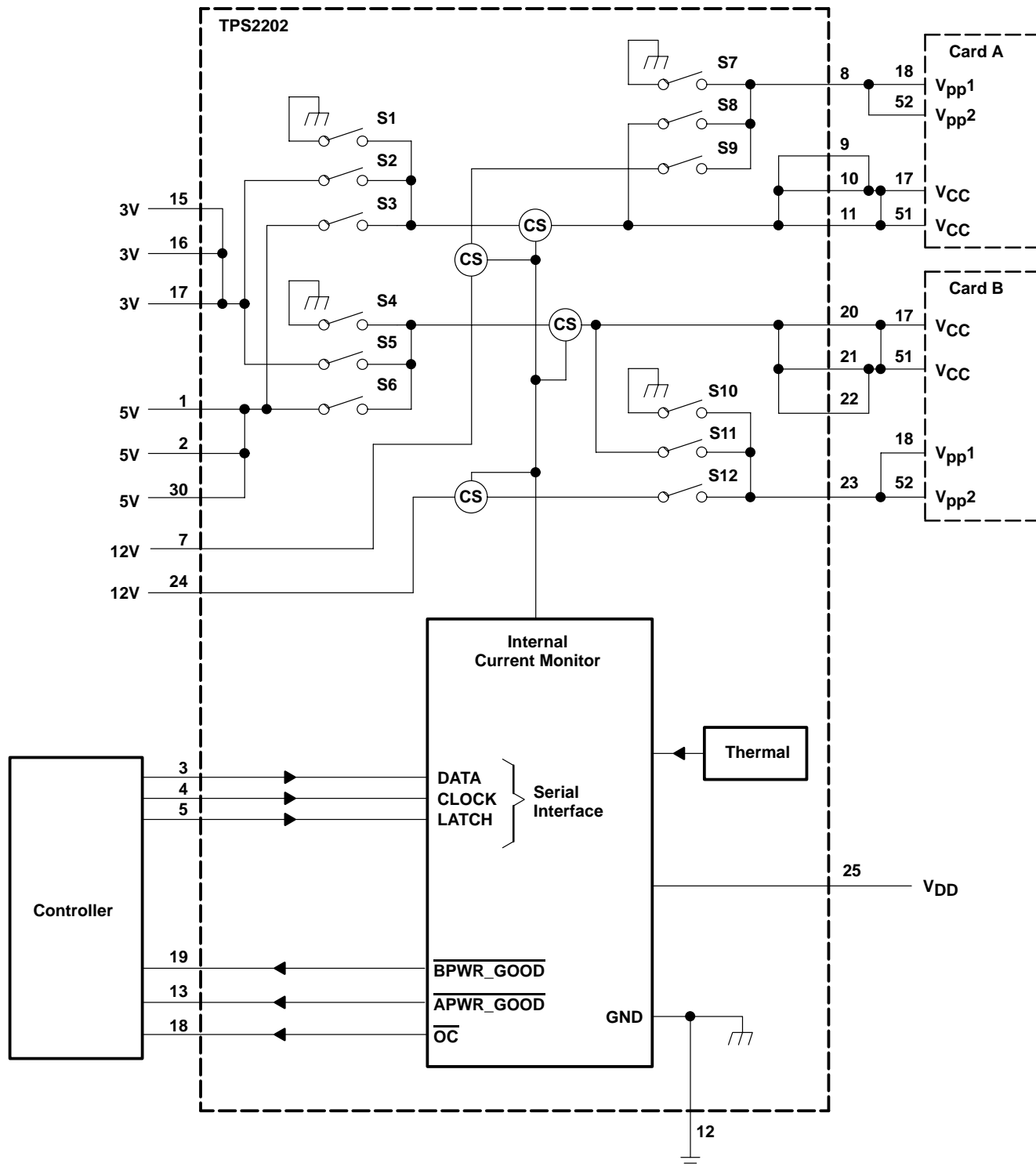

Figure 24. Internal Switching Matrix

TPS2202, TPS2202Y
DUAL-SLOT PC CARD POWER-INTERFACE SWITCHES
FOR SERIAL PCMCIA CONTROLLERS

SLVS103B – DECEMBER 1994 – REVISED JANUARY 2001

APPLICATION INFORMATION

TPS2202 control logic

AVPP

CONTROL SIGNALS			INTERNAL SWITCH SETTINGS			OUTPUT
D8 SHDN	D0 A_VPP_PGM	D1 A_VPP_VCC	S7	S8	S9	VAVPP
1	0	0	CLOSED	OPEN	OPEN	0 V
1	0	1	OPEN	CLOSED	OPEN	VCC†
1	1	0	OPEN	OPEN	CLOSED	VPP(12 V)
1	1	1	OPEN	OPEN	OPEN	Hi-Z
0	X	X	OPEN	OPEN	OPEN	Hi-Z

BVPP

CONTROL SIGNALS			INTERNAL SWITCH SETTINGS			OUTPUT
D8 SHDN	D4 B_VPP_PGM	D5 B_VPP_VCC	S10	S11	S12	VBVPP
1	0	0	CLOSED	OPEN	OPEN	0 V
1	0	1	OPEN	CLOSED	OPEN	VCC‡
1	1	0	OPEN	OPEN	CLOSED	VPP(12 V)
1	1	1	OPEN	OPEN	OPEN	Hi-Z
0	X	X	OPEN	OPEN	OPEN	Hi-Z

AVCC

CONTROL SIGNALS			INTERNAL SWITCH SETTINGS			OUTPUT
D8 SHDN	D3 A_VCC3	D2 A_VCC5	S1	S2	S3	VAVCC
1	0	0	CLOSED	OPEN	OPEN	0 V
1	0	1	OPEN	CLOSED	OPEN	3 V
1	1	0	OPEN	OPEN	CLOSED	5 V
1	1	1	CLOSED	OPEN	OPEN	0 V
0	X	X	OPEN	OPEN	OPEN	Hi-Z

BVCC

CONTROL SIGNALS			INTERNAL SWITCH SETTINGS			OUTPUT
D8 SHDN	D6 B_VCC3	D7 B_VCC5	S4	S5	S6	VBVCC
1	0	0	CLOSED	OPEN	OPEN	0 V
1	0	1	OPEN	CLOSED	OPEN	3 V
1	1	0	OPEN	OPEN	CLOSED	5 V
1	1	1	CLOSED	OPEN	OPEN	0 V
0	X	X	OPEN	OPEN	OPEN	Hi-Z

† Output depends on AVCC

‡ Output depends on BVCC

ESD protection

All TPS2202 inputs and outputs incorporate ESD-protection circuitry designed to withstand a 2-kV human-body-model discharge as defined in MIL-STD-883C, Method 3015. The V_{CC} and V_{pp} outputs can be exposed to potentially higher discharges from the external environment through the PC Card connector. Bypassing the outputs with 0.1-μF capacitors protects the devices from discharges up to 10 kV.



TPS2202, TPS2202Y DUAL-SLOT PC CARD POWER-INTERFACE SWITCHES FOR SERIAL PCMCIA CONTROLLERS

SLVS103B – DECEMBER 1994 – REVISED JANUARY 2001

APPLICATION INFORMATION

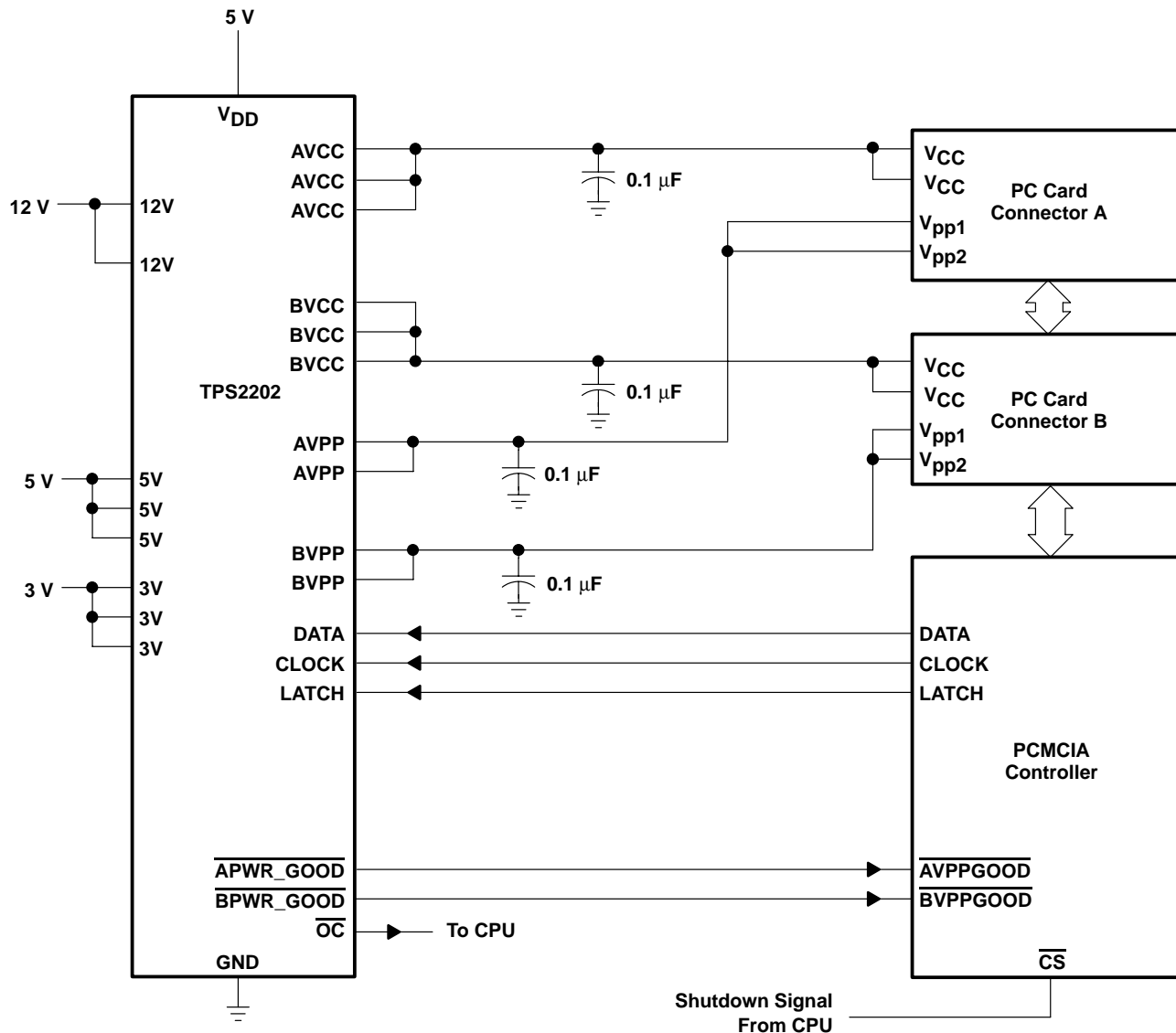

Figure 25. Detailed Interconnections and Capacitor Recommendations

PACKAGING INFORMATION

Orderable Device	Status ⁽¹⁾	Package Type	Package Drawing	Pins	Package Qty	Eco Plan ⁽²⁾	Lead/Ball Finish	MSL Peak Temp ⁽³⁾
TPS2202IDBLE	OBSOLETE	SSOP	DB	30		TBD	Call TI	Call TI
TPS2202IDFLE	OBSOLETE	SSOP	DF	30		TBD	Call TI	Call TI

⁽¹⁾ The marketing status values are defined as follows:

ACTIVE: Product device recommended for new designs.

LIFEBUY: TI has announced that the device will be discontinued, and a lifetime-buy period is in effect.

NRND: Not recommended for new designs. Device is in production to support existing customers, but TI does not recommend using this part in a new design.

PREVIEW: Device has been announced but is not in production. Samples may or may not be available.

OBSOLETE: TI has discontinued the production of the device.

⁽²⁾ Eco Plan - The planned eco-friendly classification: Pb-Free (RoHS), Pb-Free (RoHS Exempt), or Green (RoHS & no Sb/Br) - please check <http://www.ti.com/productcontent> for the latest availability information and additional product content details.

TBD: The Pb-Free/Green conversion plan has not been defined.

Pb-Free (RoHS): TI's terms "Lead-Free" or "Pb-Free" mean semiconductor products that are compatible with the current RoHS requirements for all 6 substances, including the requirement that lead not exceed 0.1% by weight in homogeneous materials. Where designed to be soldered at high temperatures, TI Pb-Free products are suitable for use in specified lead-free processes.

Pb-Free (RoHS Exempt): This component has a RoHS exemption for either 1) lead-based flip-chip solder bumps used between the die and package, or 2) lead-based die adhesive used between the die and leadframe. The component is otherwise considered Pb-Free (RoHS compatible) as defined above.

Green (RoHS & no Sb/Br): TI defines "Green" to mean Pb-Free (RoHS compatible), and free of Bromine (Br) and Antimony (Sb) based flame retardants (Br or Sb do not exceed 0.1% by weight in homogeneous material)

⁽³⁾ MSL, Peak Temp. -- The Moisture Sensitivity Level rating according to the JEDEC industry standard classifications, and peak solder temperature.

Important Information and Disclaimer:The information provided on this page represents TI's knowledge and belief as of the date that it is provided. TI bases its knowledge and belief on information provided by third parties, and makes no representation or warranty as to the accuracy of such information. Efforts are underway to better integrate information from third parties. TI has taken and continues to take reasonable steps to provide representative and accurate information but may not have conducted destructive testing or chemical analysis on incoming materials and chemicals. TI and TI suppliers consider certain information to be proprietary, and thus CAS numbers and other limited information may not be available for release.

In no event shall TI's liability arising out of such information exceed the total purchase price of the TI part(s) at issue in this document sold by TI to Customer on an annual basis.

IMPORTANT NOTICE

Texas Instruments Incorporated and its subsidiaries (TI) reserve the right to make corrections, modifications, enhancements, improvements, and other changes to its products and services at any time and to discontinue any product or service without notice. Customers should obtain the latest relevant information before placing orders and should verify that such information is current and complete. All products are sold subject to TI's terms and conditions of sale supplied at the time of order acknowledgment.

TI warrants performance of its hardware products to the specifications applicable at the time of sale in accordance with TI's standard warranty. Testing and other quality control techniques are used to the extent TI deems necessary to support this warranty. Except where mandated by government requirements, testing of all parameters of each product is not necessarily performed.

TI assumes no liability for applications assistance or customer product design. Customers are responsible for their products and applications using TI components. To minimize the risks associated with customer products and applications, customers should provide adequate design and operating safeguards.

TI does not warrant or represent that any license, either express or implied, is granted under any TI patent right, copyright, mask work right, or other TI intellectual property right relating to any combination, machine, or process in which TI products or services are used. Information published by TI regarding third-party products or services does not constitute a license from TI to use such products or services or a warranty or endorsement thereof. Use of such information may require a license from a third party under the patents or other intellectual property of the third party, or a license from TI under the patents or other intellectual property of TI.

Reproduction of TI information in TI data books or data sheets is permissible only if reproduction is without alteration and is accompanied by all associated warranties, conditions, limitations, and notices. Reproduction of this information with alteration is an unfair and deceptive business practice. TI is not responsible or liable for such altered documentation. Information of third parties may be subject to additional restrictions.

Resale of TI products or services with statements different from or beyond the parameters stated by TI for that product or service voids all express and any implied warranties for the associated TI product or service and is an unfair and deceptive business practice. TI is not responsible or liable for any such statements.

TI products are not authorized for use in safety-critical applications (such as life support) where a failure of the TI product would reasonably be expected to cause severe personal injury or death, unless officers of the parties have executed an agreement specifically governing such use. Buyers represent that they have all necessary expertise in the safety and regulatory ramifications of their applications, and acknowledge and agree that they are solely responsible for all legal, regulatory and safety-related requirements concerning their products and any use of TI products in such safety-critical applications, notwithstanding any applications-related information or support that may be provided by TI. Further, Buyers must fully indemnify TI and its representatives against any damages arising out of the use of TI products in such safety-critical applications.

TI products are neither designed nor intended for use in military/aerospace applications or environments unless the TI products are specifically designated by TI as military-grade or "enhanced plastic." Only products designated by TI as military-grade meet military specifications. Buyers acknowledge and agree that any such use of TI products which TI has not designated as military-grade is solely at the Buyer's risk, and that they are solely responsible for compliance with all legal and regulatory requirements in connection with such use.

TI products are neither designed nor intended for use in automotive applications or environments unless the specific TI products are designated by TI as compliant with ISO/TS 16949 requirements. Buyers acknowledge and agree that, if they use any non-designated products in automotive applications, TI will not be responsible for any failure to meet such requirements.

Following are URLs where you can obtain information on other Texas Instruments products and application solutions:

Products

Amplifiers	amplifier.ti.com
Data Converters	dataconverter.ti.com
DSP	dsp.ti.com
Clocks and Timers	www.ti.com/clocks
Interface	interface.ti.com
Logic	logic.ti.com
Power Mgmt	power.ti.com
Microcontrollers	microcontroller.ti.com
RFID	www.ti-rfid.com
RF/IF and ZigBee® Solutions	www.ti.com/lprf

Applications

Audio	www.ti.com/audio
Automotive	www.ti.com/automotive
Broadband	www.ti.com/broadband
Digital Control	www.ti.com/digitalcontrol
Medical	www.ti.com/medical
Military	www.ti.com/military
Optical Networking	www.ti.com/opticalnetwork
Security	www.ti.com/security
Telephony	www.ti.com/telephony
Video & Imaging	www.ti.com/video
Wireless	www.ti.com/wireless

Mailing Address: Texas Instruments, Post Office Box 655303, Dallas, Texas 75265
Copyright © 2008, Texas Instruments Incorporated