

SPECIFICATION

PATENT PENDING

- Part No. : **ASGPR.10B.4.A.25**
- Product Name : 10mm SMT 25dB Active GPS Patch Antenna with IPEX MHF Receptacle
- Features : Unique patent pending SMT GPS active patch
High performance 25dB LNA
Patch Size 10*10*4mm
Ultra low power consumption
RoHS compliant
- Photo :

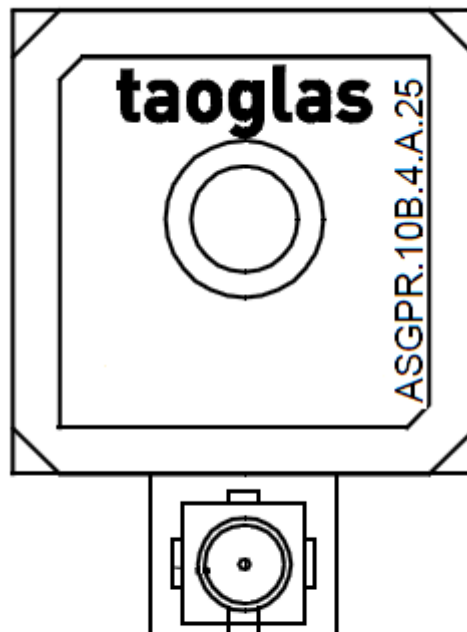

1.0 Introduction

The patent pending revolutionary powerful active SMD GPS patch antenna allows for optimal performing GPS by combining the ceramic patch, SAW, LNA, and feed pad in one integral package. Horizontally mounted on a board as any other components, GPS device designers no longer need to compromise in performance.

The right hand circular polarized patch is ideally matched to the GPS signal, tuned for maximum gain, minimal axial ratio. The SAW is placed in front of the LNA, helping prevent saturation due to nearby radio transmitters, and the possibility of radiated spurious emissions through other radio systems.

The unique SMD structure enables pick and place and reflow soldering onto boards in high volumes, with highest reliability, compared to traditional cabled solutions. All that is needed is to run a 50 Ohm co-planar waveguide to the SMD GPS receiver module.

The patch antenna can be tuned for each device environment if necessary.

2.0 Performance Measurement

2.1 Block Diagram

This antenna system consists of two functional blocks, the LNA portion and the patch antenna.

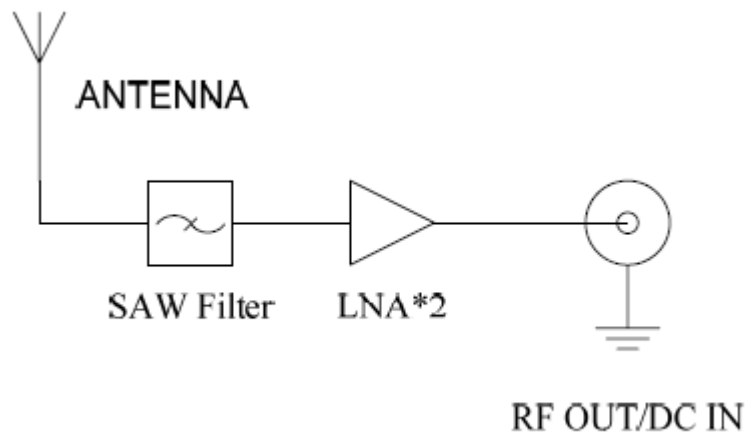

3.0 Specification

3.1 Rated Environmental Conditions

No	Parameter	Specification
3.1.1	Operation Temperature	-40°C to + 85°C
3.1.2	Storage Temperature	-40°C to + 85°C
3.1.3	Relative Humidity	40% to 95%

3.2 Electrical Specifications

No	Parameter	Specification
3.2.1	Input Voltage	Min:1.8V Typ.: 3.0V Max: 5.5V

3.3 Electrical Specifications- Antenna(10*10*4mm)

No	Parameter	Specification
3.3.1	Frequency Range	1575.42MHz +/- 1.023 MHz
3.3.2	Gain	Typ. -9dBic @ Zenith
3.3.3	Polarization	RHCP
3.3.4	Axial ratio	Max 4.0dB@zenith

3.4 Electrical Specifications- LNA

No	Parameter	Specification		
3.4.1	Frequency Range	1575.42 ± 1.023 MHz		
3.4.2	Output Impedance	50Ω		
3.4.3	Outer Band Attenuation	F0=1575.42MHz		
		F0±30MHz 5dB min		
		F0±50MHz 28dB min		
		F0±100MHz 35dB min		
3.4.4	Pout at 1dB Gain Compression point	-14 dBm Typ.@3V		
3.4.5	Output VSWR	2.0 Max		
3.4.6	LNA Gain, Power Consumption and Noise Figure			
	Voltage	LNA Gain(Typ)	Power Consumption(mA) Typ	Noise Figure(Typ)
	Min 1.8V	16dB	3.47mA	3.0dB
	Typ 3.0V	25dB	7.35mA	3.0dB
	Max 5.5V	30dB	16.7mA	3.0dB

3.5 LNA Gain and Out Band Rejection @3.0V

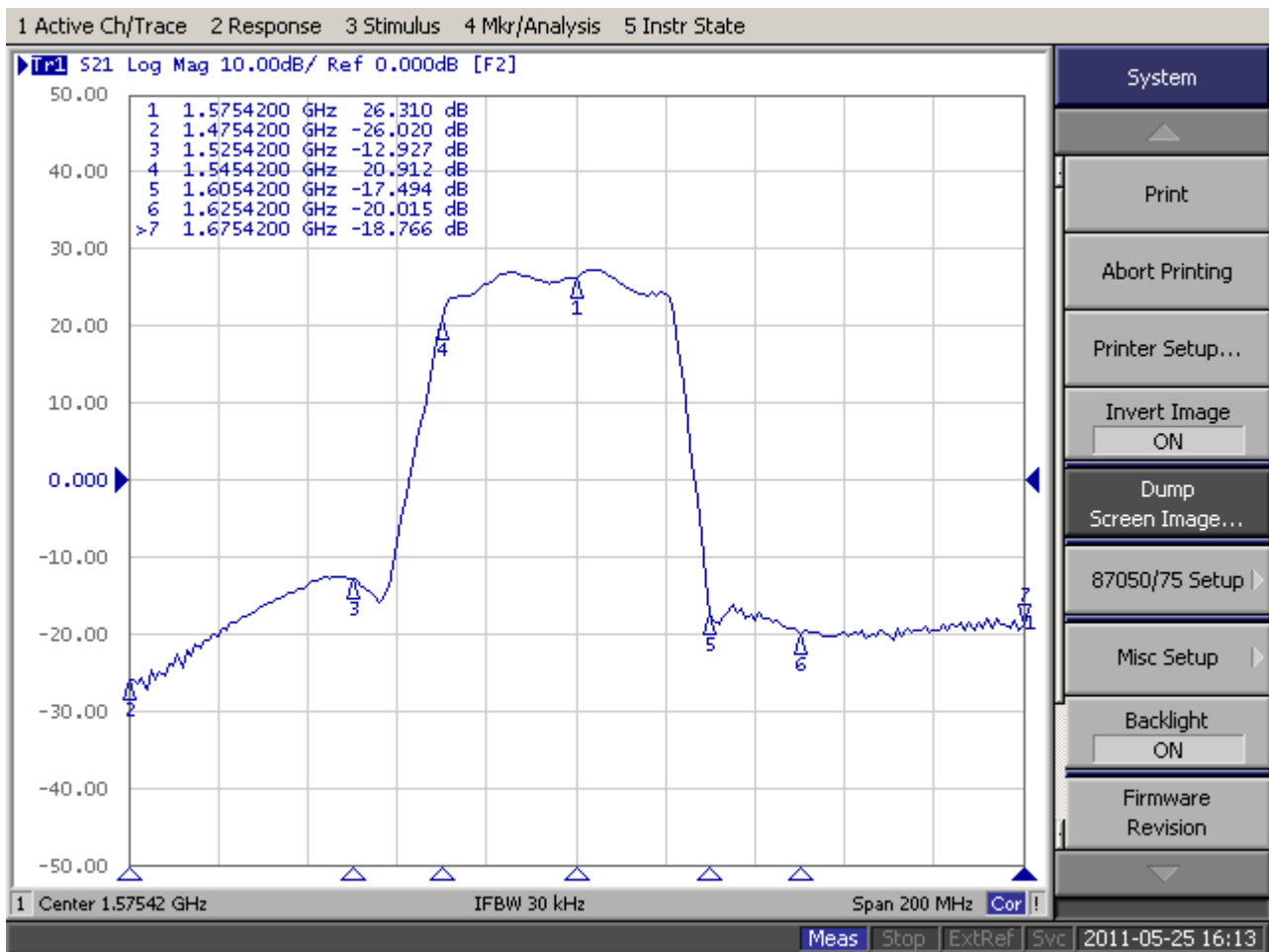

3.6 LNA Noise Figure @3.0V

Agilent 13:29:35 May 25, 2011

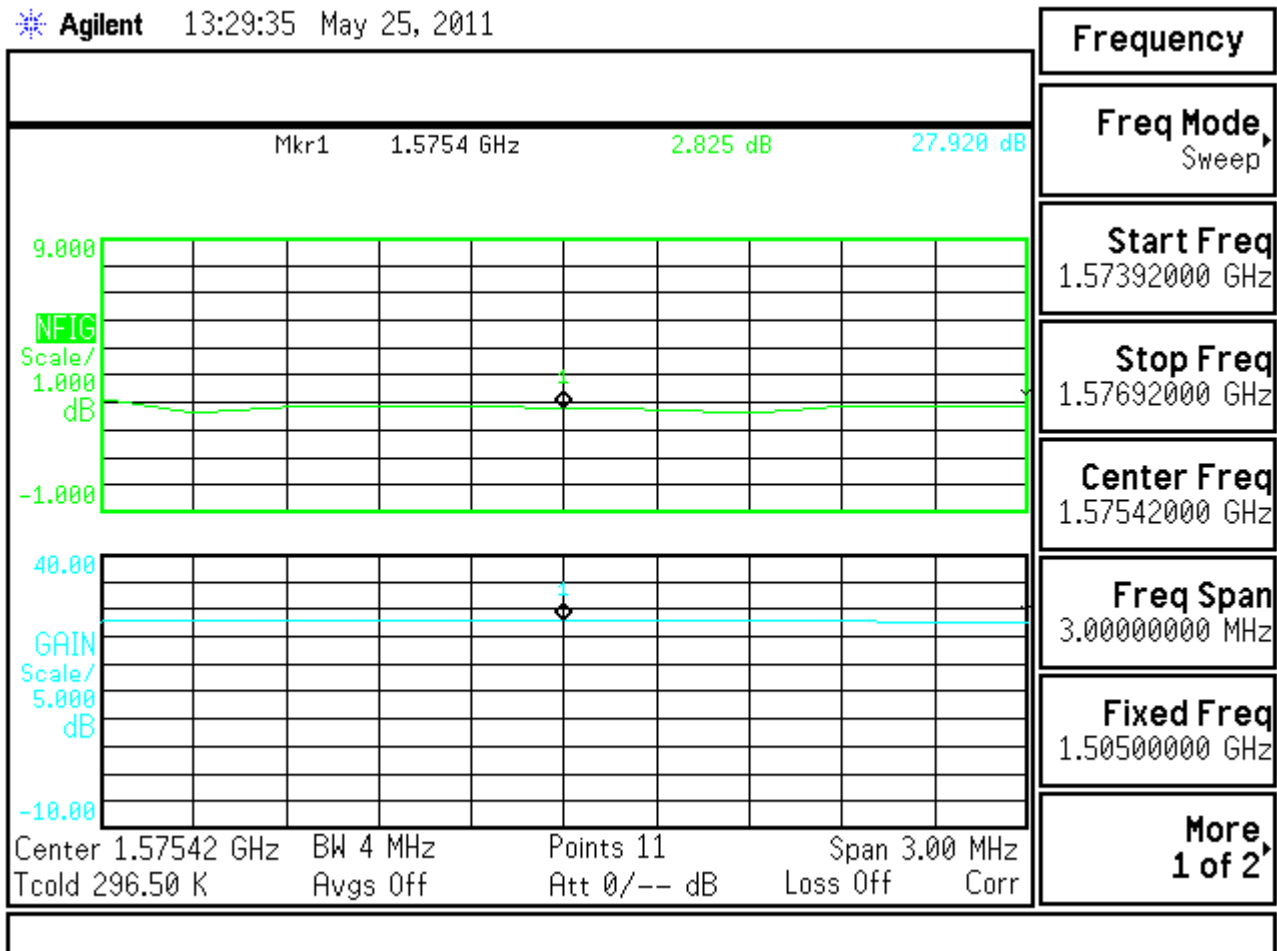

3.7 Connection

No	Parameter	Specification
3.5.1	Connection	IPEX Receptacle

3.8 Electrical Specifications- Overall

No	Parameter	Specification
3.6.1	Frequency Range	1575.42MHz +/- 1.023 MHz
3.6.2	Gain	At 90° at 3.0V 16±3dBic
3.6.3	Output Impedance	50Ω
3.6.4	VSWR	2.0 Max.

4.0 Technical drawing

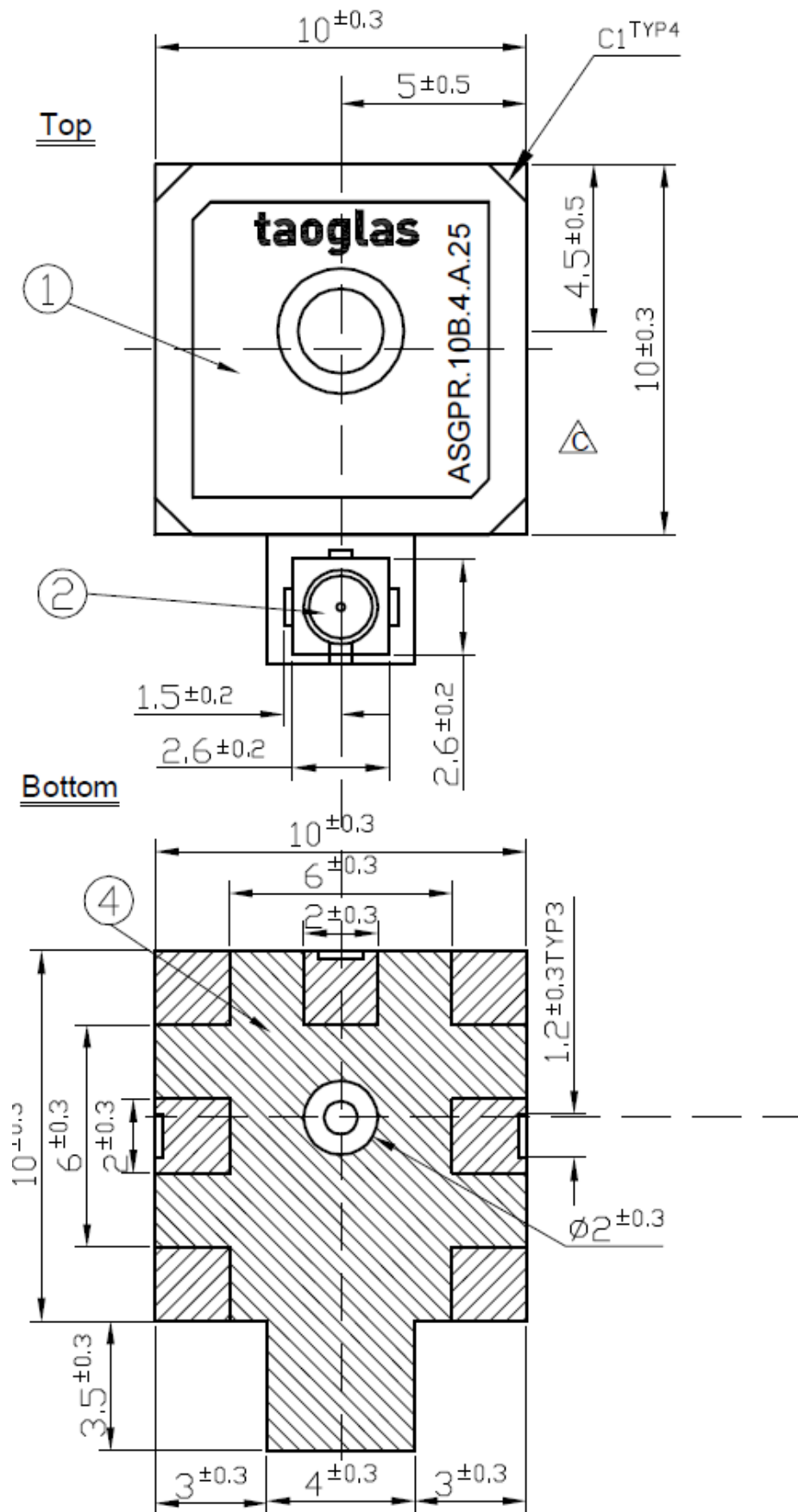

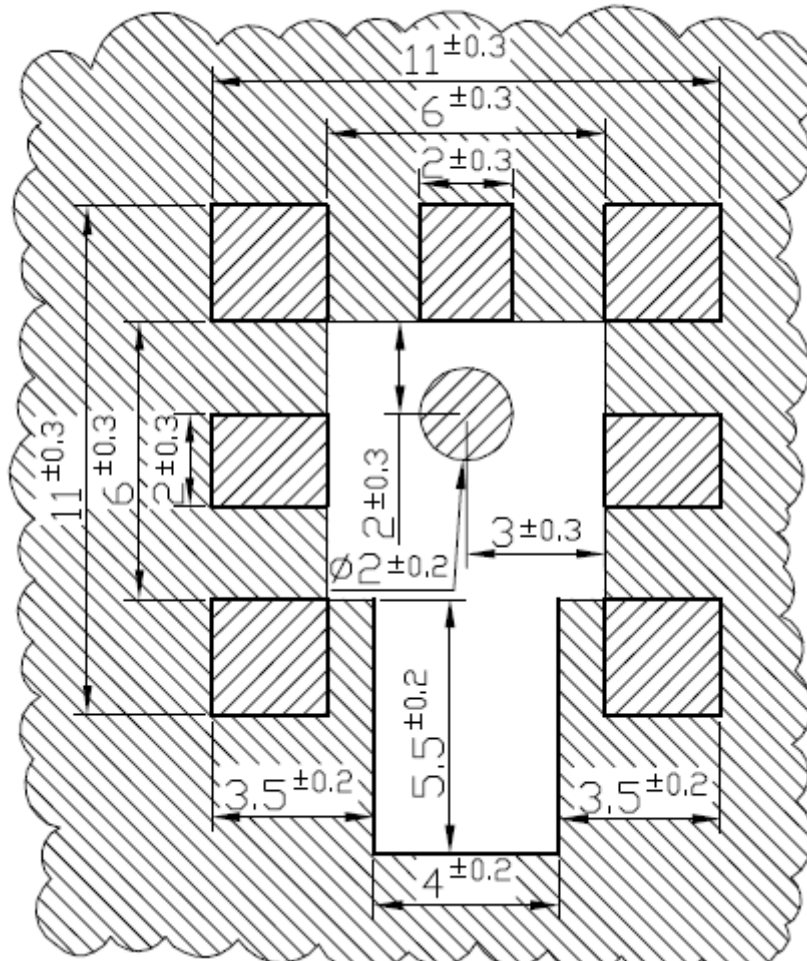

4.1 PCB Footprint

PCB Footprint

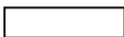

NOTES:

1. Soldered area.  (Pads for mechanical mounting purposes only)
2. Solder mask. 
3. Feedline connection is from the IPEX MHF1 receptacle.
4. Clearance area. 

5.0 Radiation patterns

XZ Plane

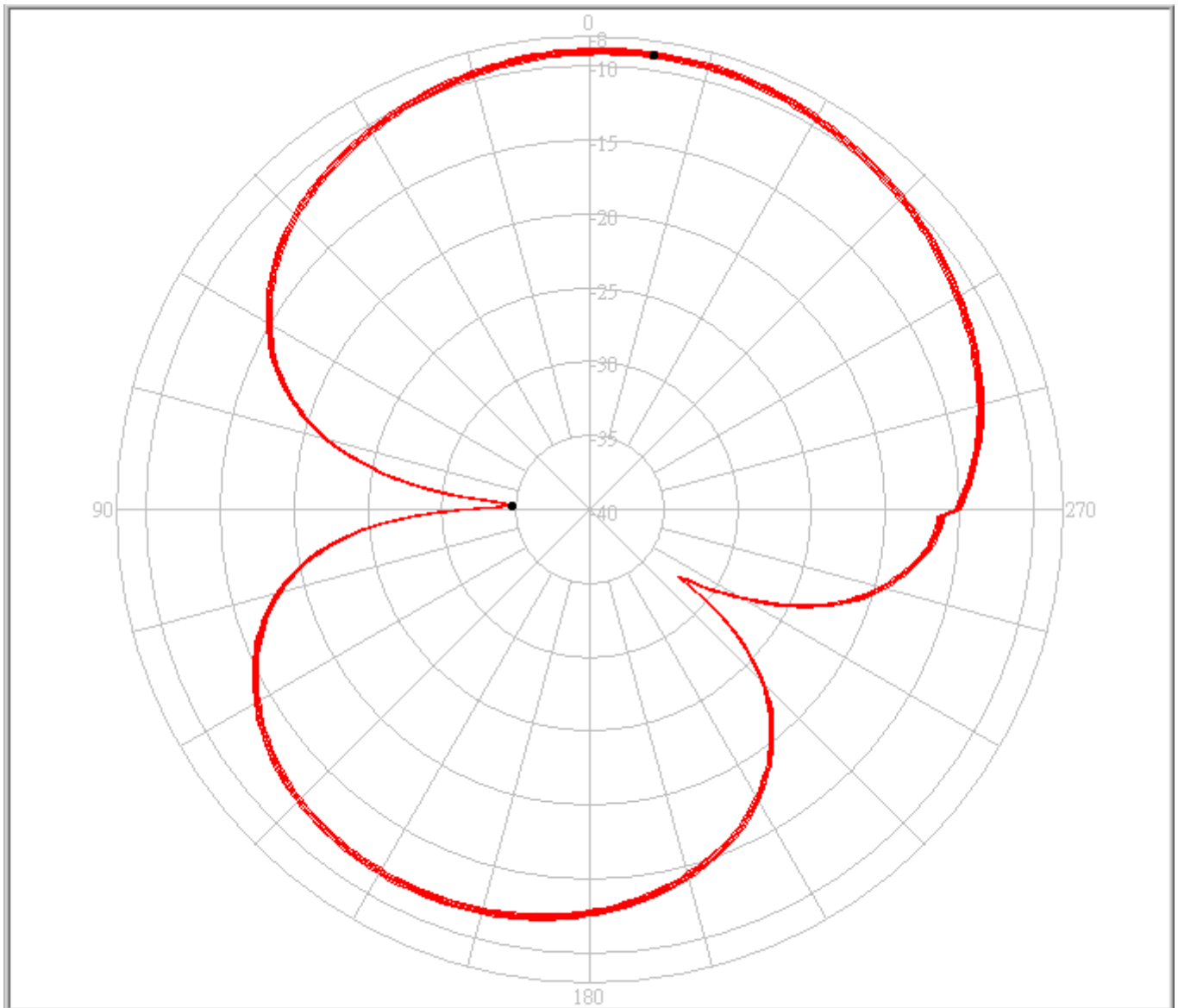

Pattern	Model No.	Test Mode	Freq(MHz)	Max Gain(dBi)	Min Gain(dBi)	Avg. Gain(dBi)	Source Polar.	Date
1	Taoglas GBA-S03	XZ	1575.42	-8.96 / 352.00	-34.78 / 87.00	-12.67	Hor.	2011/5/28

YZ Plane

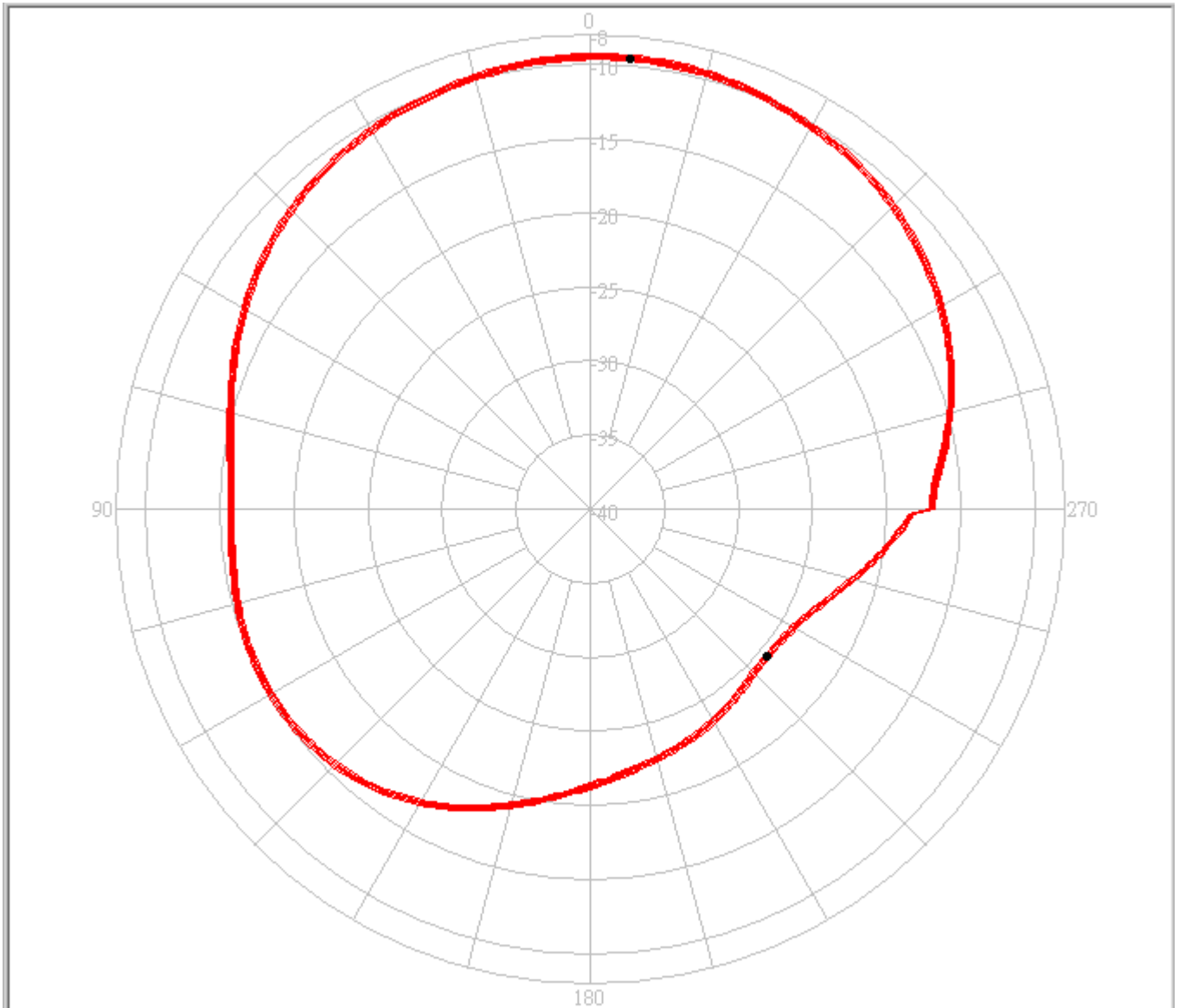

Pattern	Model No.	Test Mode	Freq(MHz)	Max Gain(dBi)	Min Gain(dBi)	Avg. Gain(dBi)	Source Polar.	Date
1	Taoglas GBA-S03	YZ	1575.42	-9.47 / 355.00	-24.47 / 230.00	-13.72	Hor.	2011/5/28

XY Plane

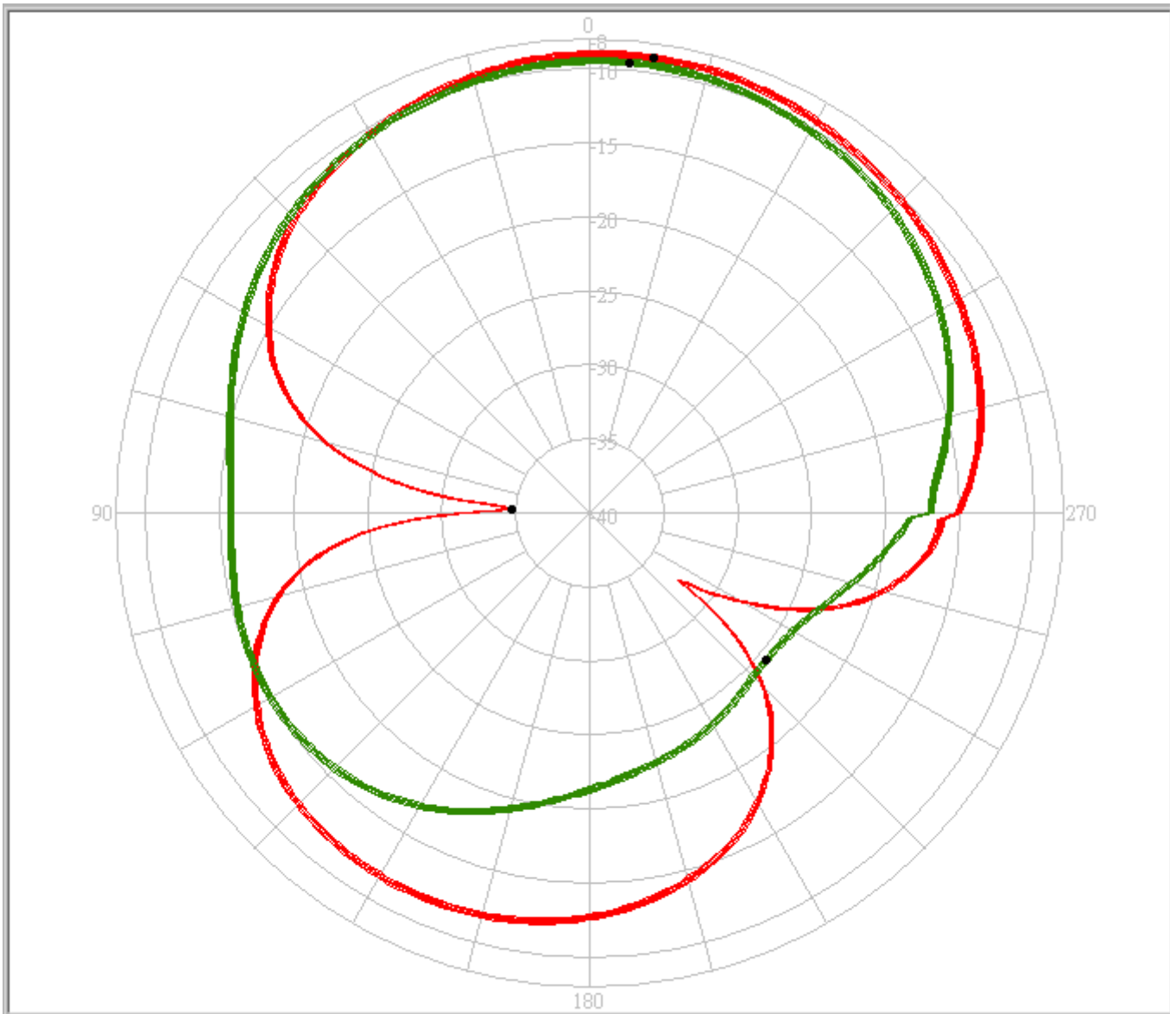

Pattern	Model No.	Test Mode	Freq(MHz)	Max Gain(dBi)	Min Gain(dBi)	Avg. Gain(dBi)	Source Polar.	Date
1	Taoglas GBA-S03	XZ	1575.42	-8.96 / 352.00	-34.78 / 87.00	-12.67	RHCP	2011/5/28
2	Taoglas GBA-S03	YZ	1575.42	-9.47 / 355.00	-24.47 / 230.00	-13.72	RHCP	2011/5/28

6.0 Test Set-up

