

7.2 mm Square Miniature Rotary DIP Switches

- Mounting space reduced by 50%, compared with 10 mm square types.
- Surface/through-hole mounting terminlas are available both Top and Side-actuated types.
- Gold-plated contacts ensure high reliability.
- Embossed 100 pcs reel type is recommended for flexible demand.

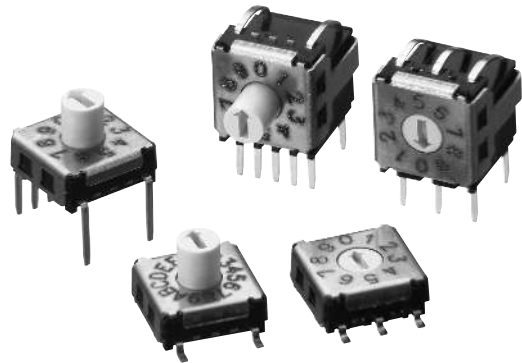

RoHS Compliant

■List of Models

● Tube Packaging

Through-hole mounting (3 × 3 Terminal)

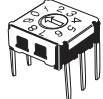
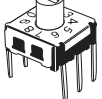
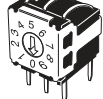
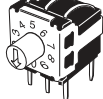
Type			Top-actuated, Flat	Top-actuated, Extended-actuator	Side-actuated, Flat	Side-actuated, Extended-actuator
						
No. of switching positions	Quantity per tube	Output code				
10	Top :63 Side:60	BCD Decimal	A6K-102RF	A6K-102RS	A6KV-102RF	A6KV-102RS
16		BCD Hexadecimal	A6K-162RF	A6K-162RS	A6KV-162RF	A6KV-162RS

Through-hole mounting (5 × 2 Terminal)

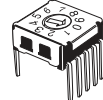
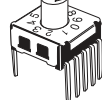
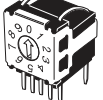
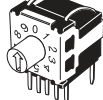
Type			Top-actuated, Flat	Top-actuated, Extended-actuator	Side-actuated, Flat	Side-actuated, Extended-actuator
						
No. of switching positions	Quantity per tube	Output code				
10	Top :63 Side:60	BCD Decimal	A6K-104RF	A6K-104RS	A6KV-104RF	A6KV-104RS
16		BCD Hexadecimal	A6K-164RF	A6K-164RS	A6KV-164RF	A6KV-164RS

Surface mounting (3 × 3 Terminal)

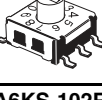
Type			Top-actuated, Flat	Top-actuated, Extended-actuator
				
No. of switching positions	Quantity per tube	Output code		
10	63	BCD Decimal	A6KS-102RF	A6KS-102RS
16		BCD Hexadecimal	A6KS-162RF	A6KS-162RS

Note: There are not side-actuator types on surface mounting with 3 × 3 terminals.

Surface mounting (5 × 2 Terminal)

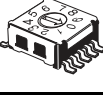
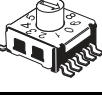
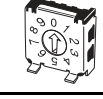
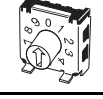
Type			Top-actuated, Flat	Top-actuated, Extended-actuator	Side-actuated, Flat	Side-actuated, Extended-actuator
						
No. of switching positions	Quantity per tube	Output code				
10	63	BCD Decimal	A6KS-104RF	A6KS-104RS	A6KSV-104RF	A6KSV-104RS
16		BCD Hexadecimal	A6KS-164RF	A6KS-164RS	A6KSV-164RF	A6KSV-164RS

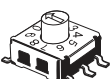

● Embossed taping

Surface mounting (3 × 3 Terminal)

Type		Top-actuated, Flat				Top-actuated, Extended-actuator			
No. of switching positions	Output code								
		Quantity per reel	Standard reel	Quantity per reel	100 pcs reel	Quantity per reel	Standard reel	Quantity per reel	100 pcs reel
10	BCD Decimal	1450	A6KS-102RF-P	100	A6KS-102RF-R100	850	A6KS-102RS-P	100	A6KS-102RS-R100
16	BCD Hexadecimal		A6KS-162RF-P		A6KS-162RF-R100		A6KS-162RS-P		A6KS-162RS-R100

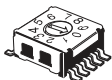
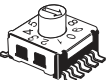
Surface mounting (5 × 2 Terminal)

Type		Top-actuated, Flat				Top-actuated, Extended-actuator			
No. of switching positions	Output code								
		Quantity per reel	Standard reel	Quantity per reel	100 pcs reel	Quantity per reel	Standard reel	Quantity per reel	100 pcs reel
10	BCD Decimal	1450	A6KS-104RF-P	100	A6KS-104RF-R100	850	A6KS-104RS-P	100	A6KS-104RS-R100
16	BCD Hexadecimal		A6KS-164RF-P		A6KS-164RF-R100		A6KS-164RS-P		A6KS-164RS-R100

Type		Side-actuated, Flat				Side-actuated, Extended-actuator			
No. of switching positions	Output code								
		Quantity per reel	Standard reel	Quantity per reel	100 pcs reel	Quantity per reel	Standard reel	Quantity per reel	100 pcs reel
10	BCD Decimal	750	A6KSV-104RF-P	100	A6KSV-104RF-R100	750	A6KSV-104RS-P	100	A6KSV-104RS-R100
16	BCD Hexadecimal		A6KSV-164RF-P		A6KSV-164RF-R100		A6KSV-164RS-P		A6KSV-164RS-R100

Note: Order in multiples of the package quantity.

■ Ratings/Characteristics

Rating (resistive load)	25 mA at 24 VDC 10 μA (minimum current) at 3.5 VDC	
Ambient operating temperature	-30 to +80°C at 60% max. (with no icing or condensation)	
Ambient operating humidity	35% to 95% (at +5 to +35°C)	
Insulation resistance	100 MΩ min. (at 250 VDC with insulation tester)	
Contact resistance (initial value)	200 mΩ max.	
Dielectric strength	Between terminals	250 VAC for 1 min
Vibration resistance	Malfunction	10 to 55 Hz, 1.5-mm double amplitude
Shock resistance	Malfunction	300 m/s ² min.
Durability	Electrical	20,000 steps min.
Washing	Not possible	
Degree of protection	IEC IP60	
Operating torque	1.96 × 10 ⁻² N·m {2 gf·m} max.	
Weight (See note.)	Through-hole mounting terminals	Top-actuated, flat: Approx. 0.4 g, Side-actuated, flat: Approx. 0.7 g
	Surface mounting terminals	Top-actuated, flat: Approx. 0.4 g, Side-actuated, flat: Approx. 0.4 g

Note: Add 0.03 g for the extended-actuator type of each model.

■Output Codes

10-position Models

Code Position	BCD Decimal code			
	1	2	4	8
0				
1	●			
2		●		
3	●	●		
4			●	
5	●		●	
6		●	●	
7	●	●	●	
8				●
9	●			●

16-position Models

Code Position	BCD Hexadecimal code			
	1	2	4	8
0				
1	●			
2		●		
3	●	●		
4			●	
5	●		●	
6		●	●	
7	●	●	●	
8				●
9	●			●
A		●		●
B	●	●		●
C			●	●
D	●		●	●
E		●	●	●
F	●	●	●	●

Note: "●" indicates that the internal switch is ON.

■ **Dimensions** (Unit: mm)

Through-hole mounting terminals

● **Top-actuated Flat Models with 3 × 3 Terminal Arrangement**

A6K-102RF

A6K-162RF

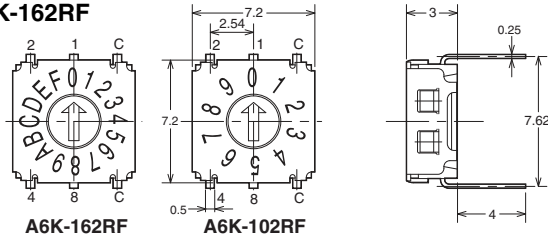

● **Top-actuated Extended-actuator Models with 3 × 3 Terminal Arrangement**

A6K-102RS

A6K-162RS

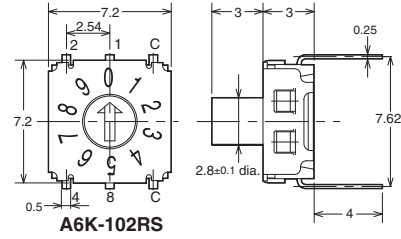

● **Side-actuated Flat Models with 3 × 3 Terminal Arrangement**

A6KV-102RF

A6KV-162RF

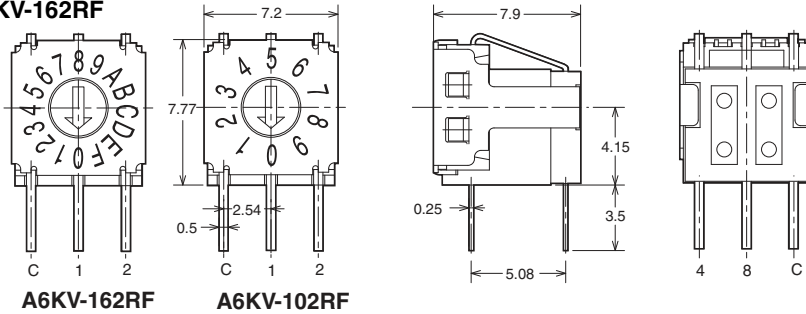

● **Side-actuated Extended-actuator Models with 3 × 3 Terminal Arrangement**

A6KV-102RS

A6KV-162RS

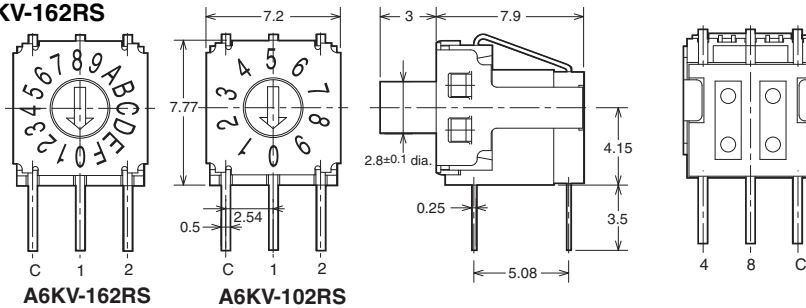

Note: Unless otherwise specified, a tolerance of ±0.4 mm applies to all dimensions.

● **Top-actuated Flat Models with 5 × 2 Terminal Arrangement**

A6K-104RF

A6K-164RF

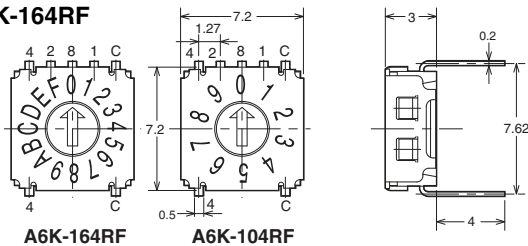

● **Top-actuated Extended-actuator Models with 5 × 2 Terminal Arrangement**

A6K-104RS

A6K-164RS

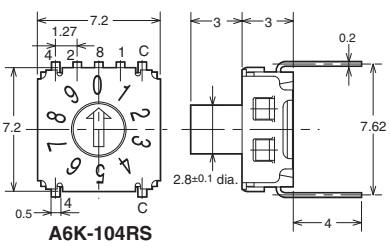

● Side-actuated Flat Models with 5 × 2 Terminal Arrangement

A6KV-104RF

A6KV-164RF

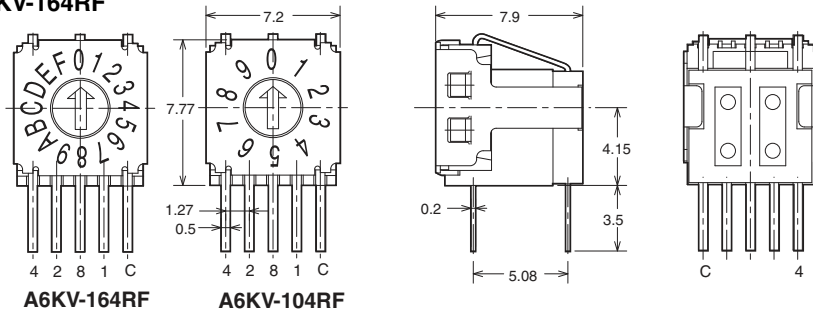

● Side-actuated Extended-actuator Models with 5 × 2 Terminal Arrangement

A6KV-104RS

A6KV-164RS

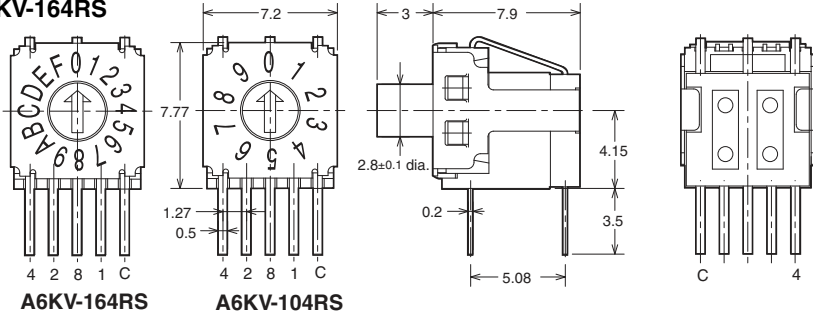

Surface mounting terminals

● Top-actuated Flat Models with 3 × 3 Terminal Arrangement

A6KS-102RF

A6KS-102-RF-R100

A6KS-162RF

A6KS-162RF-R100

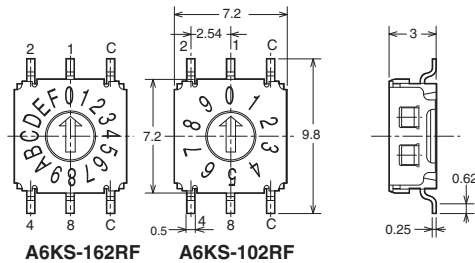

● Top-actuated Extended-actuator Models with 3 × 3 Terminal Arrangement

A6KS-102RS

A6KS-102-RS-R100

A6KS-162RS

A6KS-162RS-R100

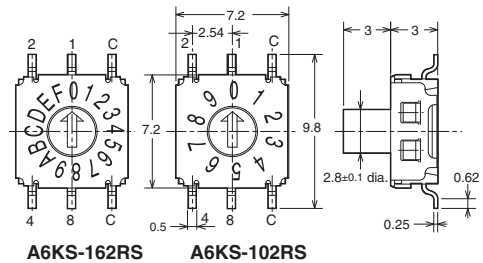

● Top-actuated Flat Models With 5 × 2 Terminal Arrangement

A6KS-104RF

A6KS-104-RF-R100

A6KS-164RF

A6KS-164RF-R100

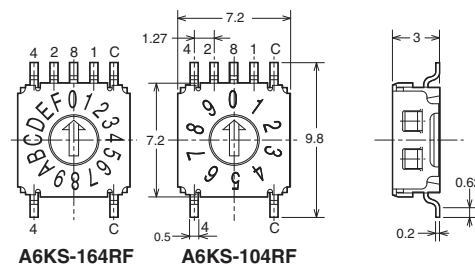

● Top-actuated Extended-actuator Models with 5 × 2 Terminal Arrangement

A6KS-104RS

A6KS-104-RS-R100

A6KS-164RS

A6KS-164RS-R100

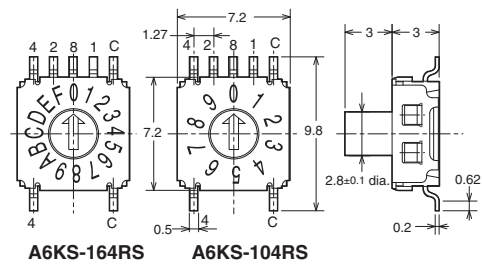

Note: Unless otherwise specified, a tolerance of ±0.4 mm applies to all dimensions.

● Side-actuated Flat Models with 5 × 2 Terminal Arrangement

- A6KSV-104RF
- A6KSV-104-RF-R100
- A6KSV-164RF
- A6KSV-164RF-R100

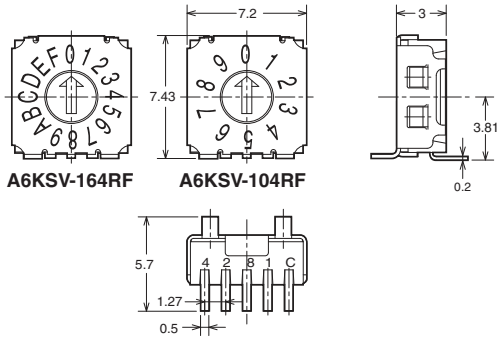

● Side-actuated Extended-actuator Models with 5 × 2 Terminal Arrangement

- A6KSV-104RS
- A6KSV-104-RS-R100
- A6KSV-164RS
- A6KSV-164RS-R100

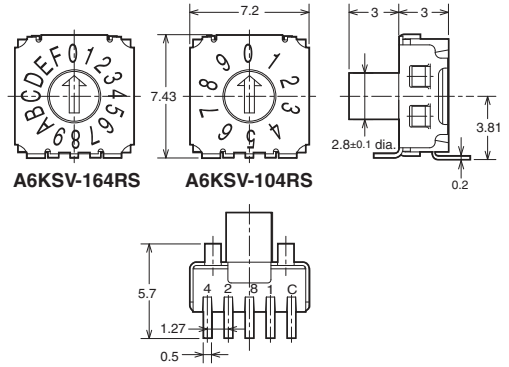

Note: Unless otherwise specified, a tolerance of ±0.4 mm applies to all dimensions.

Internal Connections

Contact Form (Top View)

**Top-actuated Models with
3 × 3 Terminal Arrangement
Through-hole mounting terminals
Surface mounting terminals**

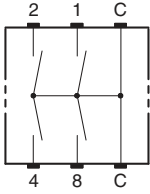

**Side-actuated Models with
3 × 3 Terminal Arrangement
Through-hole mounting terminals
Surface mounting terminals**

Actuator side (A6KV)

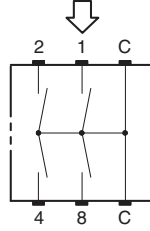

**Top-actuated Models with
5 × 2 Terminal Arrangement
Through-hole mounting terminals
Surface mounting terminals**

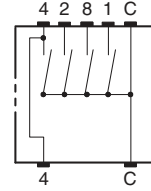

**Side-actuated Models with
5 × 2 Terminal Arrangement
Through-hole mounting terminals**

Actuator side

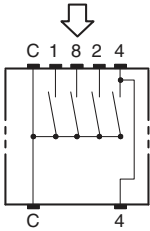

**Side-actuated Models with
5 × 2 Terminal Arrangement
Surface mounting terminals**

Actuator side

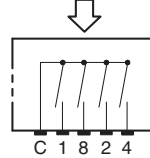

PCB Dimensions (Reference) (Unit: mm)

Top View

3 x 3 Terminal Arrangement
Through-hole mounting terminals
(Top-actuated Models)

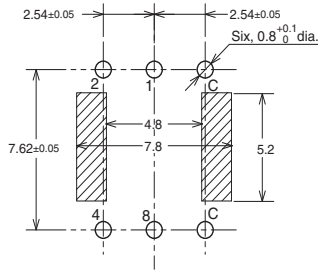

3 x 3 Terminal Arrangement
Through-hole mounting terminals
(Side-actuated Models)

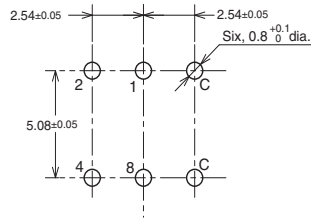

3 x 3 Terminal Arrangement
Surface mounting terminals
(Top-actuated Models)

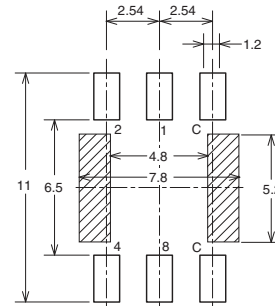

5 x 2 Terminal Arrangement
Through-hole mounting terminals
(Top-actuated Models)

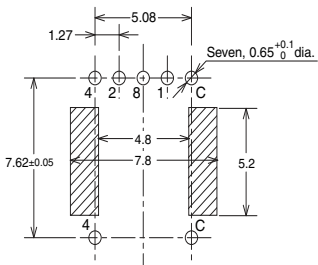

5 x 2 Terminal Arrangement
Through-hole mounting terminals
(Side-actuated Models)

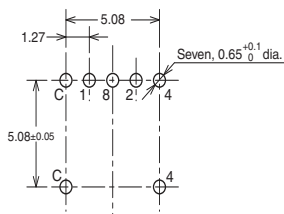

5 x 2 Terminal Arrangement
Surface mounting terminals
(Top-actuated Models)

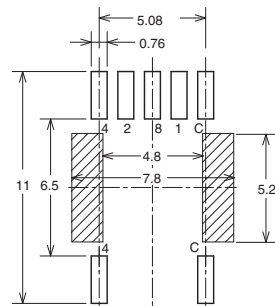

5 x 2 Terminal Arrangement
Surface mounting terminals
(Side-actuated Models)

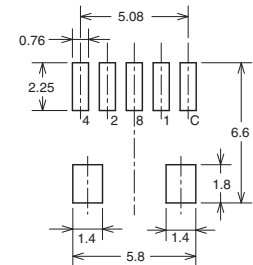

:Through hole and Pattern prohibited area

Note: Unless otherwise specified, a tolerance of ±0.4 mm applies to all dimensions.

Precautions

Be sure to read the Safety precautions common to all DIP Switches for correct use.

Please check each region's Terms & Conditions by region website.

OMRON Corporation
Electronic and Mechanical Components Company

Regional Contact

Americas
<https://www.components.omron.com/>
Asia-Pacific
<https://ecb.omron.com.sg/>
Korea
<https://www.omron-ecb.co.kr/>

Europe
<http://components.omron.eu/>
China
<https://www.ecb.omron.com.cn/>
Japan
<https://www.omron.co.jp/ecb/>

© OMRON Corporation 2007-2021 All Rights Reserved.
In the interest of product improvement, specifications are subject to change without notice.

Cat. No. A174-E1-07
0321(0207)