

Base strip - MC 1,5/ 3-G-3,5 THT-R32 - 1996692

Please be informed that the data shown in this PDF Document is generated from our Online Catalog. Please find the complete data in the user's documentation. Our General Terms of Use for Downloads are valid (<http://phoenixcontact.com/download>)



Header, Nominal current: 8 A, Rated voltage (III/2): 160 V, Number of positions: 3, Pitch: 3.5 mm, Color: black, Contact surface: Tin, Assembly: Taped SMD/THT/THR components, User information and design recommendations for through hole reflow technology can be found under "Downloads"

Product Features

- 3.5 mm pitch
- Low-profile THR headers with a compact pitch
- Plug-in direction parallel to the PCB
- Delivery form: box packaging, in bulk for small series
- Delivery form: tape-on-reel packing according to IEC 60286-3 for automated mounting
- Use in SMT reflow processes



Key commercial data

Packing unit	1 pc
Minimum order quantity	470 pc
Weight per Piece (excluding packing)	1.8 GRM
Custom tariff number	85366990
Country of origin	Germany

Technical data

Dimensions

Length	9.2 mm
Pitch	3.5 mm
Dimension a	7 mm
Pin dimensions	0,8 x 0,8 mm
Hole diameter	1.4 mm

General

Range of articles	MC 1,5/...-G-THT
-------------------	------------------

Base strip - MC 1,5/ 3-G-3,5 THT-R32 - 1996692

Technical data

General

Insulating material group	IIIa
Rated surge voltage (III/3)	2.5 kV
Rated surge voltage (III/2)	2.5 kV
Rated surge voltage (II/2)	2.5 kV
Rated voltage (III/3)	160 V
Rated voltage (III/2)	160 V
Rated voltage (II/2)	250 V
Connection in acc. with standard	EN-VDE
Nominal current I _N	8 A
Maximum load current	8 A (per position)
Insulating material	PA-GF
Inflammability class according to UL 94	V0
Color	black
Number of positions	3

Classifications

eCl@ss

eCl@ss 4.0	272607xx
eCl@ss 4.1	27260701
eCl@ss 5.0	27260701
eCl@ss 5.1	27260701
eCl@ss 6.0	27260704
eCl@ss 7.0	27440402
eCl@ss 8.0	27440402

ETIM

ETIM 3.0	EC001121
ETIM 4.0	EC002637
ETIM 5.0	EC002637

UNSPSC

UNSPSC 6.01	30211810
UNSPSC 7.0901	39121409
UNSPSC 11	39121409
UNSPSC 12.01	39121409
UNSPSC 13.2	39121409

Base strip - MC 1,5/ 3-G-3,5 THT-R32 - 1996692

Approvals

Approvals

Approvals

UL Recognized / VDE Gutachten mit Fertigungsüberwachung / cUL Recognized / IEC60321-10-1 / IEC60321-10-2 / GOST / GOST / CCA / cULus Recognized

Ex Approvals

Approvals submitted

Approval details

UL Recognized 		
	B	D
Nominal current I _N	8 A	8 A
Nominal voltage U _N	300 V	300 V

VDE Gutachten mit Fertigungsüberwachung 	
Nominal current I _N	8 A
Nominal voltage U _N	160 V

cUL Recognized 		
	B	D
Nominal current I _N	8 A	8 A
Nominal voltage U _N	300 V	300 V

Base strip - MC 1,5/ 3-G-3,5 THT-R32 - 1996692

Approvals

IECEE CB Scheme	
Nominal current I _N	8 A
Nominal voltage U _N	160 V

GOST	
------	--

GOST	
------	--

CCA	
Nominal current I _N	8 A
Nominal voltage U _N	160 V

cULus Recognized	
------------------	--

Drawings

Dimensioned drawing

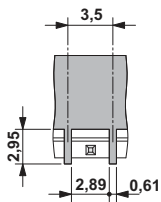

Drilling diagram

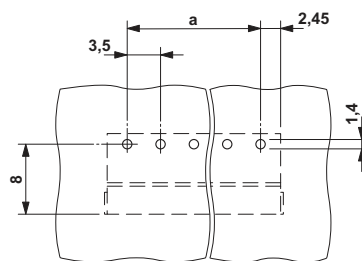

Base strip - MC 1,5/ 3-G-3,5 THT-R32 - 1996692

Dimensioned drawing

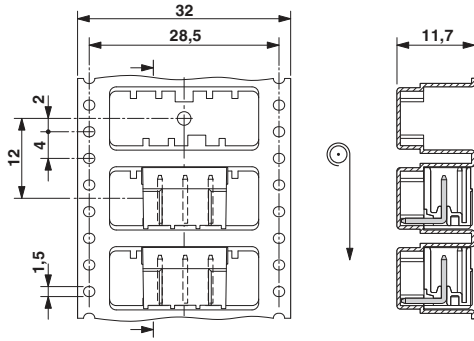

Dimensioned drawing

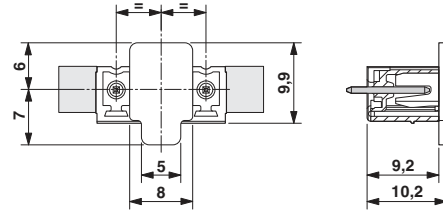

Dimensioned drawing

