

**FLUKE**®

**— Hart Scientific**®

***1523, 1524***  
*Reference Thermometer*  
*Technical Guide*

## **Limited Warranty & Limitation of Liability**

Each product from Fluke Corporation, Hart Scientific Division (“Hart”) is warranted to be free from defects in material and workmanship under normal use and service. The warranty period is one year(s) for the Reference Thermometer. The warranty period begins on the date of the shipment. Parts, product repairs, and services are warranted for 90 days. The warranty extends only to the original buyer or end-user customer of a Hart authorized reseller, and does not apply to fuses, disposable batteries or to any other product, which in Hart’s opinion, has been misused, altered, neglected, or damaged by accident or abnormal conditions of operation or handling. Hart warrants that software will operate substantially in accordance with its functional specifications for 90 days and that it has been properly recorded on non-defective media. Hart does not warrant that software will be error free or operate without interruption. Hart does not warrant calibrations on the Reference Thermometer.

Hart authorized resellers shall extend this warranty on new and unused products to end-user customers only but have no authority to extend a greater or different warranty on behalf of Hart. Warranty support is available if product is purchased through a Hart authorized sales outlet or Buyer has paid the applicable international price. Hart reserves the right to invoice Buyer for importation costs of repairs/replacement parts when product purchased in one country is submitted for repair in another country.

Hart’s warranty obligation is limited, at Hart’s option, to refund of the purchase price, free of charge repair, or replacement of a defective product which is returned to a Hart authorized service center within the warranty period.

To obtain warranty service, contact your nearest Hart authorized service center or send the product, with a description of the difficulty, postage, and insurance prepaid (FOB Destination), to the nearest Hart authorized service center. Hart assumes no risk for damage in transit. Following warranty repair, the product will be returned to Buyer, transportation prepaid (FOB Destination). If Hart determines that the failure was caused by misuse, alteration, accident or abnormal condition or operation or handling, Hart will provide an estimate or repair costs and obtain authorization before commencing the work. Following repair, the product will be returned to the Buyer transportation prepaid and the Buyer will be billed for the repair and return transportation charges (FOB Shipping Point).

**THIS WARRANTY IS BUYER’S SOLE AND EXCLUSIVE REMEDY AND IS IN LIEU OF ALL OTHER WARRANTIES, EXPRESS OR IMPLIED, INCLUDING BUT NOT LIMITED TO ANY IMPLIED WARRANTY OF MERCHANTABILITY OR FITNESS FOR A PARTICULAR PURPOSE. HART SHALL NOT BE LIABLE FOR ANY SPECIAL, INDIRECT, INCIDENTAL OR CONSEQUENTIAL DAMAGES OR LOSSES, INCLUDING LOSS OF DATA, WHETHER ARISING FROM BREACH OF WARRANTY OR BASED ON CONTRACT, TORT, RELIANCE OR ANY OTHER THEORY.**

Since some countries or states do not allow limitation of the term of an implied warranty, or exclusion or limitation of incidental or consequential damages, the limitations and exclusions of this warranty may not apply to every buyer. If any provision of this Warranty is held invalid or unenforceable by a court of competent jurisdiction, such holding will not affect the validity or enforceability of any other provision.

### **Fluke Corporation, Hart Scientific Division**

799 E. Utah Valley Drive • American Fork, UT 84003-9775 • USA

Phone: +1.801.763.1600 • Telefax: +1.801.763.1010

E-mail: [support@hartscientific.com](mailto:support@hartscientific.com)

**[www.hartscientific.com](http://www.hartscientific.com)**

Specifications subject to change without notice. • Copyright © 2008 • Printed in USA

---

## Table of Contents

<b>1</b>	<b>Before You Start .....</b>	<b>1</b>
1.1	Introduction .....	1
1.2	Standard Equipment .....	1
1.3	Safety Information .....	1
1.3.1	 Warning .....	1
1.3.2	Cautions .....	2
1.4	CE Comments .....	3
1.4.1	EMC Directive .....	3
1.4.2	Immunity Testing .....	3
1.4.2.1	For Use As a Portable (Hand-held) Instrument .....	3
1.4.2.2	For Use As a Benchtop Instrument (AC Adapter) .....	4
1.4.3	Locking out non SI units .....	4
1.5	Using Clamp-On Ferrites .....	4
1.6	Emissions Testing .....	5
1.7	Low Voltage Directive (Safety) .....	5
1.8	Authorized Service Centers .....	5
<b>2</b>	<b>Quick Start.....</b>	<b>7</b>
2.1	Setup.....	7
2.2	Specifications .....	17
<b>3</b>	<b>General Operation .....</b>	<b>23</b>
3.1	Battery.....	23
3.2	DC Power Source .....	23
3.3	Probe .....	24
3.3.1	Internal or External reference junction compensation may be used with this instrument. ....	25
3.3.2	TC Internal Reference Junction.....	25
3.3.3	TC External Reference Junction.....	25
3.4	Probe Lock Function.....	25
3.5	INFO-CON Connector.....	26
<b>4</b>	<b>Display Functions and User Interface .....</b>	<b>29</b>
4.1	Main Screen.....	29
4.2	STATS.....	29
4.3	°C °F .....	29

4.4	HOLD	29
4.5	SETUP	30
4.5.1	Channel T1	30
4.5.1.1	Probe	30
4.5.1.2	Config	30
4.5.1.3	Base X	30
4.5.1.4	Aux Displ	30
4.5.1.5	Temp Res	31
4.5.1.6	RJ	31
4.5.2	Channel T2 (1524 Only)	31
4.5.2.1	Probe	32
4.5.2.2	Config	32
4.5.2.3	Base X	32
4.5.2.4	Aux Displ	32
4.5.2.5	Temp Res	33
4.5.3	Instrument	33
4.5.3.1	Fast Scan Mode	33
4.5.3.2	Contrast	33
4.5.3.3	Auto-Off	33
4.5.3.4	Backlight Time	33
4.5.3.5	Serial Port	33
4.5.3.6	Baud Rate	34
4.5.3.7	Date/Time	34
4.6	SAVE	34
4.7	ARROWS, UP, DOWN	34
4.8	ENTER	35
4.9	RECALL	35
4.9.1	Review Saved	35
4.9.2	Send Saved	35
4.9.3	Delete Saved	35
4.9.4	Send Logs	35
4.9.5	Delete Logs	36
4.10	NEXT	36
4.11	SHIFT	36
4.12	RESET	36
4.13	$\Omega$ mV	36
4.14	TREND	36
4.15	LOG	37
4.15.1	Free	37
4.15.2	Interval	37
4.15.3	Tag	38

---

4.15.4 Session.....	38
4.16 HOME .....	38
<b>5 LOGS .....</b>	<b>39</b>
5.1 DEMAND LOG .....	39
5.2 AUTO-LOG .....	39
5.2.1 Auto-Log Operation.....	39
5.2.2 Sending Auto Log Data to a Computer.....	41
5.2.3 Data Upload Format.....	41
5.2.4 Deleting Auto Log Data.....	41
<b>6 Digital Communication Interface.....</b>	<b>43</b>
6.1 Wiring.....	43
6.1.1 Setup.....	44
6.1.2 Serial Operation .....	44
6.1.3 Data Upload Format .....	44
6.2 Command Syntax .....	44
6.3 Serial Commands by Function or Group .....	45
6.4 Serial Commands - Alphabetic Listing .....	48
<b>7 Calibration of Your Reference Thermometer Readout .....</b>	<b>77</b>
7.1 General .....	77
7.2 Introduction.....	77
7.3 Terminology.....	77
7.4 Fundamentals .....	77
7.5 Environmental Test Conditions.....	77
7.6 Calibration Equipment .....	77
7.7 Manual Calibration.....	78
7.7.1 General.....	78
7.7.2 As Found Data Procedure.....	80
7.7.2.1 As Found Calibration Parameters .....	80
7.7.2.2 As Found Data.....	80
7.7.3 Alignment Procedure.....	80
7.7.3.1 Alignment Test Data .....	80
7.7.3.2 Calculate New Adjustment Values .....	80
7.7.4 As Left Data.....	80
7.8 Preparation for Reference Thermometer Calibration.....	80
7.8.1 Serial Communication .....	80
7.8.2 Cabling .....	81

7.8.3	Scan Mode.....	81
7.8.4	AC Adapter .....	81
7.9	Manual Calibration Process.....	81
7.9.1	Procedure.....	82
7.9.1.1	Visual Inspection .....	82
7.9.1.2	1523/24 Calibration Parameters (As Found).....	82
7.9.1.3	1523/24 Accuracy Test (As Found).....	84
7.9.2	1523/24 Alignment .....	89
7.9.2.1	L75_OHMS Range.....	92
7.9.2.2	LO_OHMS Range.....	92
7.9.2.3	MED_OHMS Range.....	92
7.9.2.4	HI_OHMS Range .....	92
7.9.2.5	Millivolt Range .....	92
7.9.3	1523/24 As Left Test Data .....	93
<b>8</b>	<b>Troubleshooting .....</b>	<b>95</b>
<b>9</b>	<b>Maintenance .....</b>	<b>97</b>
	<b>Index.....</b>	<b>99</b>

---

## Figures

Figure 1 Locking out non SI units .....	4
Figure 2 Clamp-On Ferrite .....	5
Figure 3 Input/Output Connections - 1523 .....	7
Figure 4 Input/Output Connections - 1524 .....	8
Figure 5 Keys.....	9
Figure 6 1523 Menu.....	11
Figure 7 1523 Menu (cont) .....	11
Figure 8 1523 Menu (cont) .....	12
Figure 9 1524 Menu.....	14
Figure 10 1524 Menu (cont) .....	14
Figure 11 1524 Menu (cont) .....	15
Figure 12 1524 Menu (cont) .....	16
Figure 13 1524 Menu (cont) .....	17
Figure 14 1524 Menu (cont) .....	17
Figure 15 12V DC Power source Polarity .....	24
Figure 16 Probe wiring diagrams.....	27
Figure 17 RS-232 wiring .....	44
Figure 18 Flow chart for manual calibration .....	79

## Tables

Table 1 International Symbols.....	3
Table 2 1523 Input/Output Connections .....	7
Table 3 1524 Input/Output Connections .....	8
Table 4 1523 Key Functions.....	10
Table 5 1524 Key Functions.....	12
Table 6 General Specifications .....	18
Table 7 Millivolt Measurement.....	18
Table 8 Reference Junction Compensation.....	18
Table 9 Ohms Measurement, RTDs .....	18
Table 10 Ohms Measurement, Thermistor .....	19
Table 11 Equivalent temperature accuracies derived from primary specifications ( $\Omega$ , mV) .....	19
Table 12 Temperature, Thermocouples External Reference Junction .....	20
Table 13 Temperature, RTD Ranges and Accuracies (RTD-90).....	21
Table 14 Temperature, Thermistor .....	21
Table 15 Fast Scan Mode Specifications .....	21
Table 16 Sample Interval per Channel in Seconds.....	21
Table 17 Channel to Channel Differential Specifications .....	22
Table 18 Commands by Function or Group.....	46
Table 19 Statistical Types .....	73
Table 20 Probe Conversion Types .....	73
Table 21 Probe Characterization Parameters .....	74
Table 22 Calibration Range Identifiers.....	75
Table 23 Demand Log Statistical Types .....	76
Table 24 Error Messages .....	76
Table 25 Test Equipment Specifications .....	78
Table 26 Standard Reference Resistor Specification .....	78
Table 27 Standard Voltage Reference Specification .....	78
Table 28 1523/24 Accuracy Test Settings and Specifications.....	81
Table 29 1523/24 Accuracy Test Settings and Specifications – Voltage .....	82
Table 30 As Found Readout/Calibration Parameter Settings .....	82
Table 31 1523/24 Alignment Settings .....	89



# 1 Before You Start

## 1.1 Introduction

The Reference Thermometers (1523, 1524) are designed to be reliable, stable, temperature measuring instruments that can be used in the field or laboratory. They offer accuracy, portability, and speed for nearly every field calibration application. The instruments have been designed with the field user in mind and are easy to use while maintaining stability, uniformity, and accuracy comparable to some laboratory instruments. Your Fluke 1523 and 1524 thermometers are a handheld, battery operated instrument that measures temperature using Platinum resistance Thermometers (PRT), Thermistors, and Thermocouples (TC).

## 1.2 Standard Equipment

Unpack the instrument carefully and inspect it for any damage that may have occurred during shipment. If there is shipping damage, notify the carrier immediately.

Verify that the following components are present:

- 1523/1524 Reference Thermometer with 3 AA batteries
- AC Adapter, with power cord
- RS-232 Cable
- User's Guide
- Documentation CD
- Report of Calibration and calibration label
- Clamp-on ferrite(s)

If all items are not present, contact an Authorized Service Center. (See Section 1.8, Authorized Service Centers on page 5.)

## 1.3 Safety Information

The Reference Thermometer is designed in accordance with EN 61010-1 {2nd Edition}, and CAN/CSA 22.2 No 61010.1-04. Use this instrument only as specified in this manual, otherwise the protection provided by the instrument may be impaired.

A **Warning** identifies conditions and actions that pose hazard(s) to the user; a **Caution** identifies conditions and actions that may damage the instrument being used.

International symbols used on the reference thermometer and in this manual are explained in Table 1 on page 3.

### 1.3.1 Warning

To avoid possible electric shock or personal injury:

- Do not use the reference thermometer in environments other than those listed in the user's guide.

















- Do not use the reference thermometer for any application other than that which is specified. The instrument was designed for temperature measurement and calibration. Any other use of the instrument may cause unknown hazards to the user.
- If the reference thermometer is used in a manner not in accordance with the equipment design, the operation and the protection provided by the instrument may be impaired. In addition, safety hazards may arise.
- Do not apply more than the rated voltage, as marked on the reference thermometer, between the inputs, or between any input and earth ground (30 V, 24 mA max all terminals).
- Follow all equipment safety procedures.
- Calibration equipment should only be used by trained personnel.
- The reference thermometer is intended for indoor use only.
- Before you use the instrument, inspect the case. Look for cracks or missing plastic. Pay particular attention to the insulation surrounding the connectors. Do not use the reference thermometer if it appears damaged or operates abnormally. Protection may be impaired. When in doubt, have the instrument serviced.
- Always use an isolated RTD or PRT (metal sheath isolated from lead wires).
- Make sure the battery door is closed and latched before you operate the reference thermometer.
- Do not operate the reference thermometer around explosive gas, vapor, or dust.
- For battery operation use only 3 AA batteries, properly installed in the reference thermometer case.
- On the 1524 model, thermocouples can only be used on channel 1.

### 1.3.2 Cautions

To avoid possible damage to the reference thermometer or to equipment under test:

- Do not apply more than the rated voltage, as marked on the reference thermometer, between the inputs, or between any input and earth ground (30 V 24 mA max all terminals).
- Unless recalibrating the instrument DO NOT change the values of the calibration constants from the factory set values. The correct setting of these parameters is important to the safety and proper operation of the instrument.
- The instrument and any thermometer probes used with it are sensitive instruments that can be easily damaged. Always handle these devices with care. DO NOT allow them to be dropped, struck, stressed, or overheated.
- DO NOT operate this instrument in an excessively wet, oily, dusty, or dirty environment.
- Use the proper probes, function and range for your measurement.
- Ensure probe coefficients are downloaded.

**Table 1** International Symbols

Symbol	Description	Symbol	Description
	AC (Alternating Current)		PE Ground
	AC-DC		Hot Surface (Burn Hazard)
	Battery		Read the User's Guide (Important Information)
	Complies with European Union directives		Off
	DC		On
	Double Insulated		Canadian Standards Association
	Electric Shock		C-TICK Australian EMC mark
	Fuse		The European Waste Electrical and Electronic Equipment (WEEE) Directive (2002/96/EC) mark.

## 1.4 CE Comments

### 1.4.1 EMC Directive

Hart Scientific's equipment has been tested to meet the European Electromagnetic Compatibility Directive (EMC Directive, 2004/108/EC ). The Declaration of Conformity for your instrument lists the specific standards to which the unit was tested.

The instrument was designed specifically as a test and measuring device. Compliance to the EMC directive is through EN 61326-1:2006 Electrical equipment for measurement, control and laboratory use – EMC requirements

As noted in the EN 61326-1, the instrument can have varying configurations. The instrument was tested in a typical configuration with shielded RS-232 cables.

### 1.4.2 Immunity Testing

#### 1.4.2.1 For Use As a Portable (Hand-held) Instrument

The instrument was tested to Basic Immunity Requirements for portable test and measurement equipment.

### 1.4.2.2 For Use As a Benchtop Instrument (AC Adapter)

The instrument was tested to Immunity Requirements for Controlled EM Environments. Utilized in this state the instrument is designed to operate in a controlled electromagnetic environment. The instrument experiences degradation in the presence of strong fields in the frequency range of 150 to 200 MHz and we suggest that it not be used in close proximity to VHF transmitters.

### 1.4.3 Locking out non SI units

Through a specific key-press sequence, the user can choose to disable the °C °F toggle switch so that temperature is displayed in SI units only. Once the units toggle switch has been locked, subsequent key presses will not allow temperature to be displayed in °F.

#### Instructions for locking out non SI units (see illustration below)

1. Simultaneously press and hold down the °C °F key and the BACKLIGHT key, press the POWER ON key
2. The display will read: SI units only ON
3. Release the °C °F and the BACKLIGHT key
4. The °C °F key will no longer toggle between units

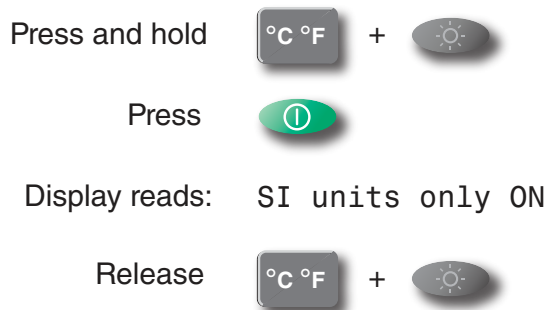

Figure 1 Locking out non SI units

Repeating the steps above will enable the °C °F toggle switch allowing temperature to be displayed in °F. The display will read: SI units only OFF

## 1.5 Using Clamp-On Ferrites

Clamp-on ferrites are provided for use in improving the instrument’s electromagnetic (EM) immunity in environments of excessive EM interference, like areas of heavy industrial equipment. We recommend placing the ferrites on the cables of probes attached to the instrument.

To attach a ferrite to a probe cable, make a loop in the cable near the connector and clamp the ferrite around half of the loop as shown in the diagram. The ferrite can be

easily detached and moved to a new probe when needed. (See Figure 2 on opposite page.)

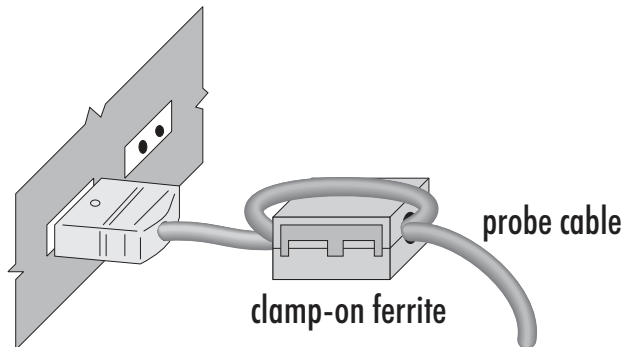

*Figure 2 Clamp-On Ferrite*

## 1.6 Emissions Testing

The instrument fulfills the limit requirements for Class B.

## 1.7 Low Voltage Directive (Safety)

In order to comply with the European Low Voltage Directive (2006/95/EC), Fluke equipment has been designed to meet the EN 61010-1.

## 1.8 Authorized Service Centers

Please contact one of the following authorized Service Center to coordinate service on your Fluke product:

**Fluke Corporation**  
**Hart Scientific Division**  
Phone: +1.801.763.1600

**Fluke Nederland B.V.**  
Phone: +31-402-675300

**Fluke Int'l Corporation - CHINA**  
Phone: +86-10-6-512-3436

**Fluke South East Asia Pte Ltd. - SINGAPORE**  
Phone: +65-6799-5588

When contacting a Service Center for support, please have the following information available:

- Model Number
- Serial Number
- Complete description of the problem



## 2 Quick Start

### 2.1 Setup

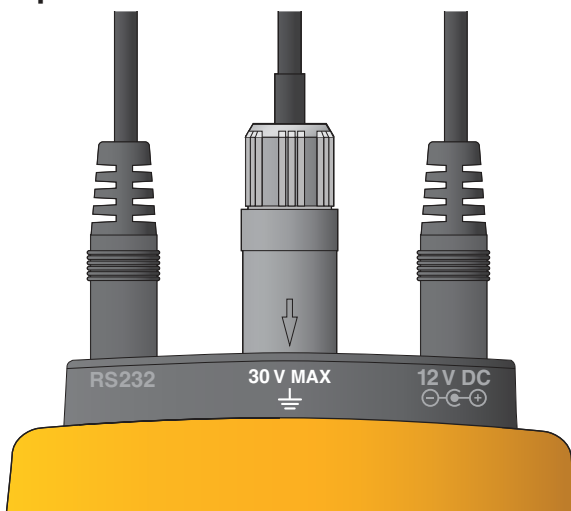

**Figure 3** Input/Output Connections - 1523

**Table 2** 1523 Input/Output Connections

No.	Name	Description
1	Serial	Serial interface connector
2	Connector, T1	Sensor Connector, Channel 1
4	Power	External Power adapter connection

## 1523, 1524 Reference Thermometer

### Setup

---

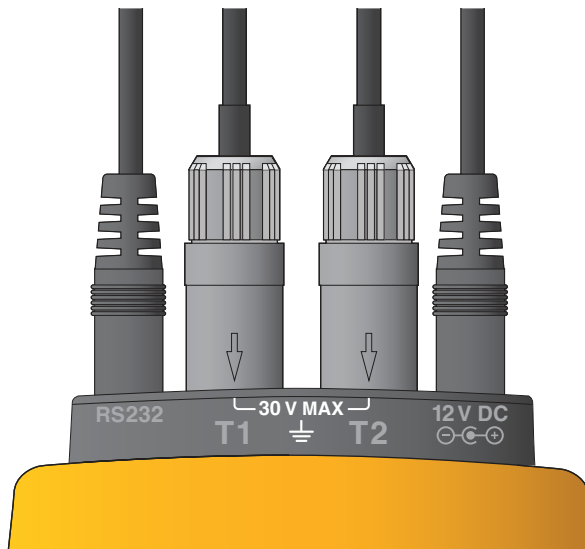

**Figure 4** Input/Output Connections - 1524

**Table 3** 1524 Input/Output Connections

No	Name	Description
1	Serial	Serial interface connector
2	Connector, T1	Sensor Connector, Channel 1
3	Connector, T2	Sensor Connector, Channel 2
4	Power	External Power adapter connection





















Figure 5 Keys

# 1523, 1524 Reference Thermometer

## Setup

**Table 4** 1523 Key Functions

No	Key	Description
1		Power on or off
2		Yellow Second or Special Function Key
3		Turns the backlight on or off
4		1st Press: MAX, 2nd Press: MIN, 3rd Press: AVE, 4th Press: STD DEV
5		Units, °C/°F
6		1st press - Holds value on screen "-- HOLD --" across bottom of screen. 2nd press - Releases Screen hold.
7		Enters setup menu, see menu structure
8		Saves measurement as a logged data point
9		Arrows increment or decrement selections in an active field. In Graph Mode, Arrows change the scale of the graph.
10		Selects highlighted selection, Saves a new selection.
11		1st Press - Enters Recall menu, 2nd Press - Exits Recall Menu
12		Moves down to next option on screen.
13		"RESET" - Resets Stats Data
14		"Ω mV" - Toggles from °C to Ω or Ω to °C (PRT, thermistor), °C to mV or mV to °C (TC)
15		"TREND" - Starts Graphing data
16		"HOME" Returns user to main screen

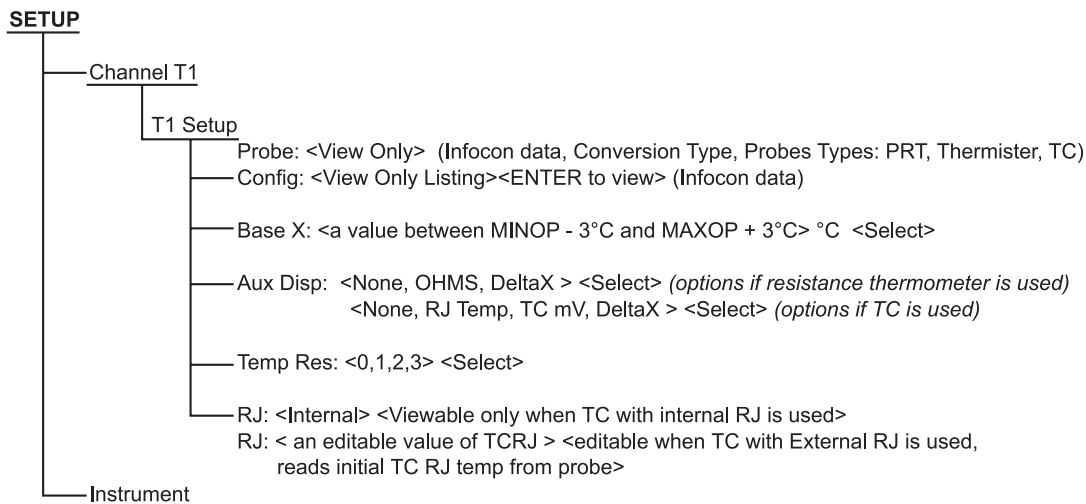

**Figure 6** 1523 Menu

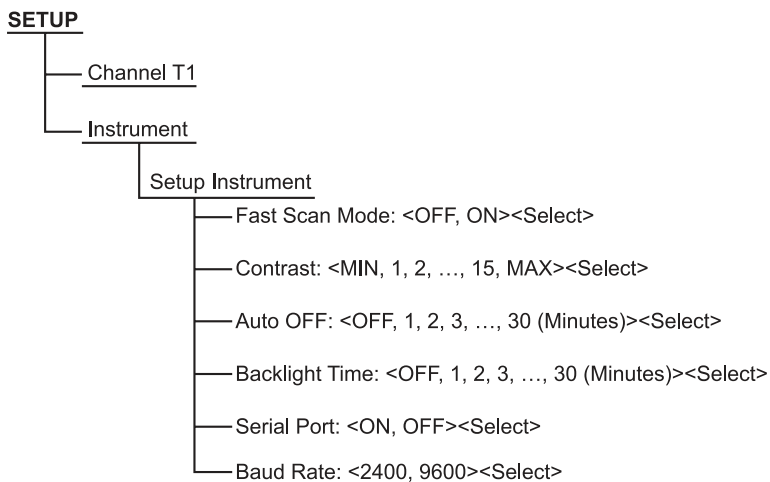



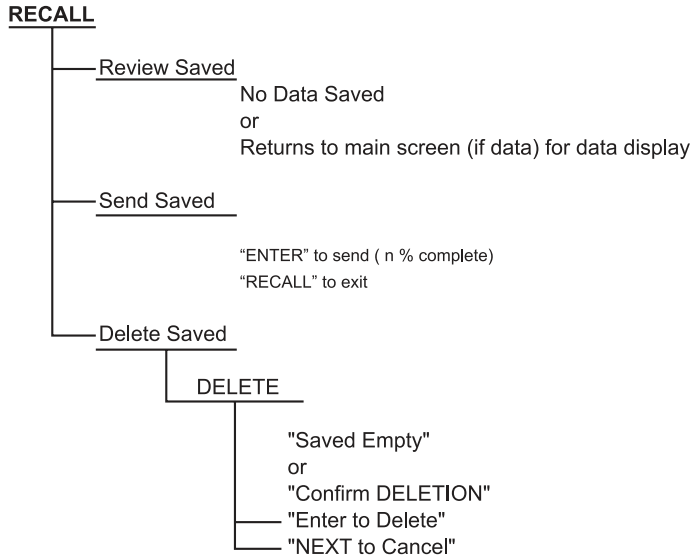



















**Figure 7** 1523 Menu (cont)



**Figure 8** 1523 Menu (cont)

**Table 5** 1524 Key Functions

No	Key	Description
1		Power on or off
2		Yellow Second or Special Function Key
3		Turns the backlight on or off
4		1st Press: Max, 2nd Press: Min, 3rd Press: Ave, 4th Press: STD DEV
5		Units, °C/°F
6		1st press - Holds value on screen "-- HOLD --" across bottom of screen. 2nd press - Releases Screen hold.
7		Enters setup menu, see menu structure
8		Saves measurement as a logged data point

No	Key	Description
9	 	Arrows increment or decrement selections in an active field. In Graph Mode, Arrows change the scale of the graph.
10		Selects highlighted selection, Saves a new selection.
11		1st press - Enters Recall Menu, 2nd press - Exits Recall Menu
12		Moves down to next option on screen.
13	 + 	"RESET" - Resets Stats Data
14	 + 	"Ω mV" - Toggles from °C to Ω or Ω to °C (PRT, thermistor), °C to mV or mV to °C (TC)
15	 + 	"TREND" - Starts Graphing data
16	 + 	"LOG" - Log a series of measurements, see Auto Log in menu structure
17	 + 	"HOME" Returns user to main screen

# 1523, 1524 Reference Thermometer

## Setup

---

### SETUP

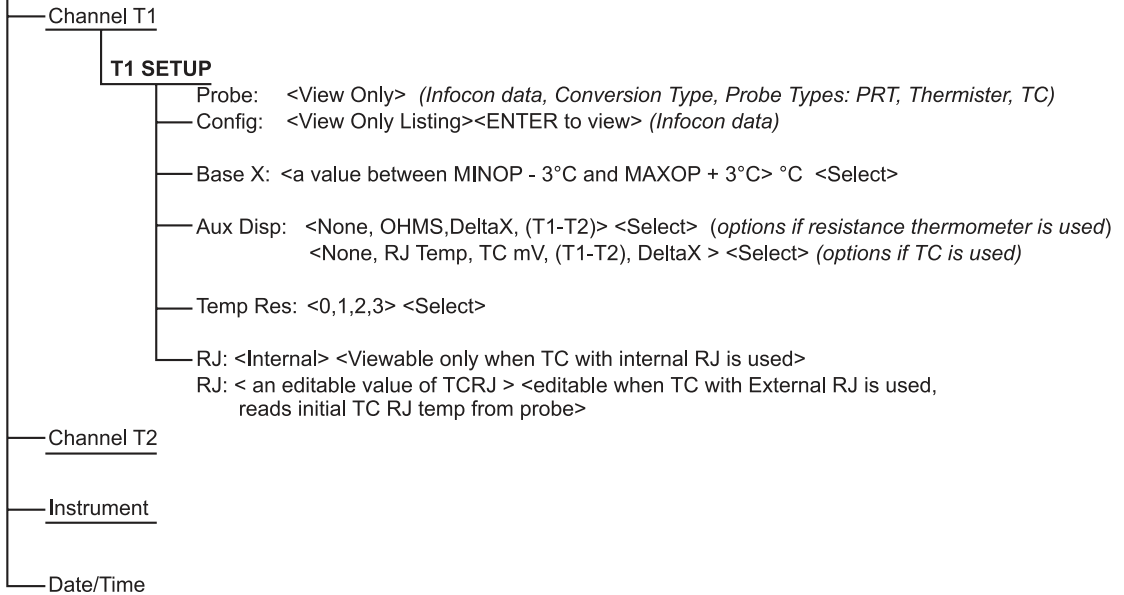

Figure 9 1524 Menu

### SETUP

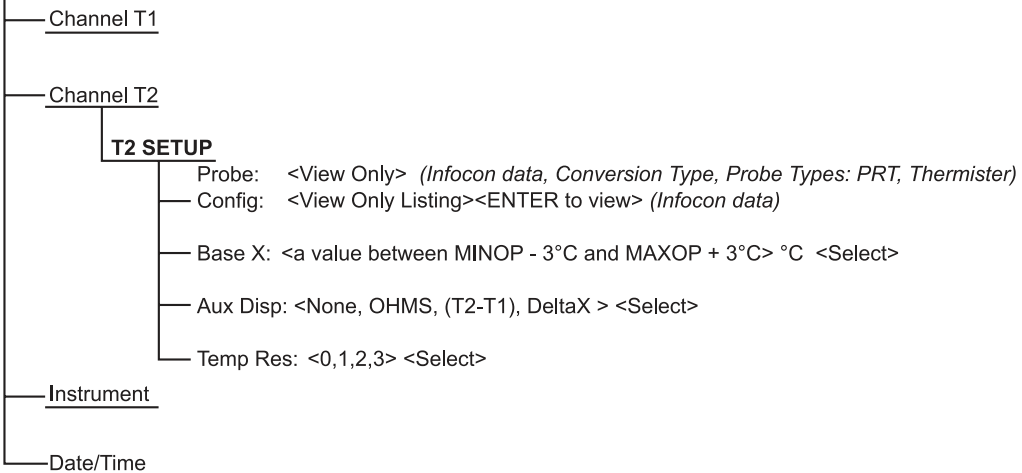
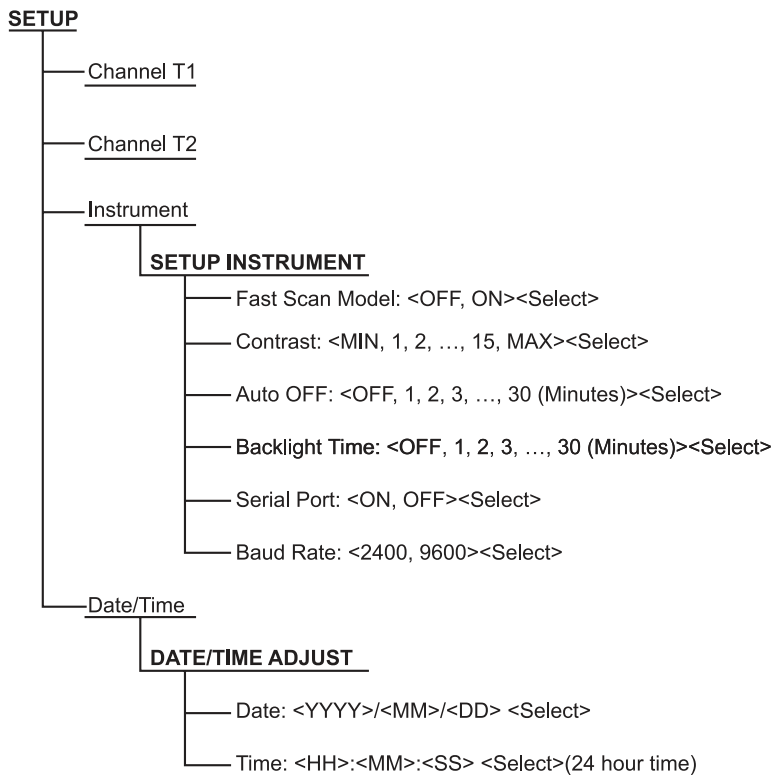

Figure 10 1524 Menu (cont)



**Figure 11** 1524 Menu (cont)

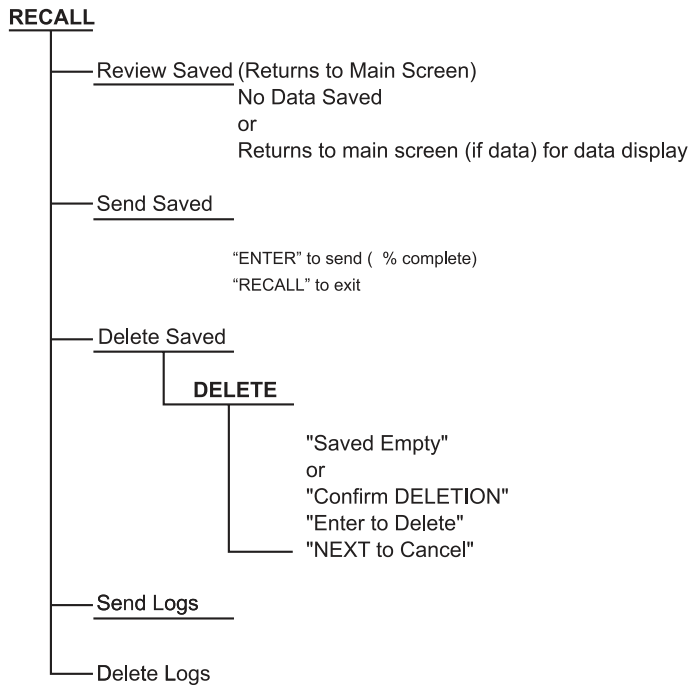
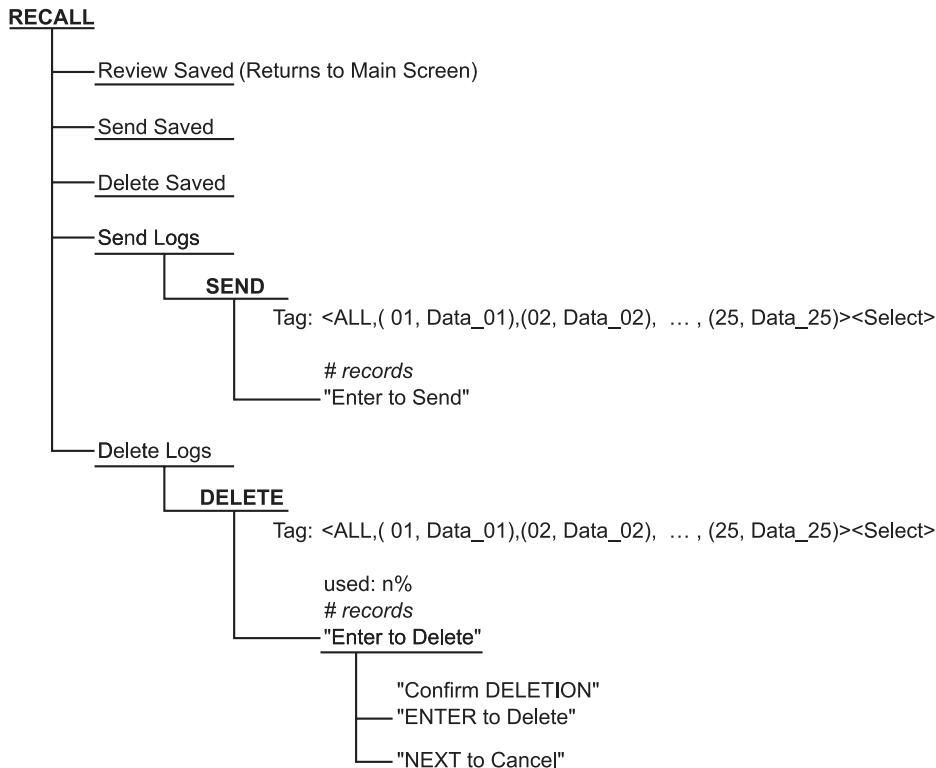
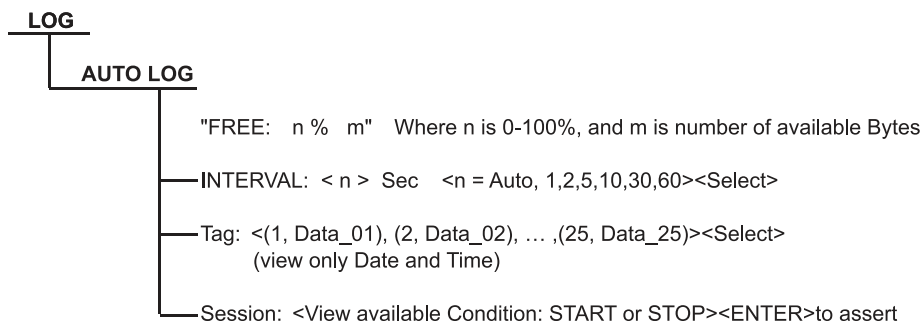

Figure 12 1524 Menu (cont)





*Figure 13 1524 Menu (cont)*



*Figure 14 1524 Menu (cont)*

## 2.2 Specifications

Specifications are based on a one year calibration cycle and apply from 13 °C to 33 °C unless stated otherwise. All specifications assume a five minute warm up period

# 1523, 1524 Reference Thermometer

## Specifications

**Table 6** General Specifications

<b>Operating Temperature<sup>†</sup></b>	-10 °C to 60 °C 0 °C to 60 °C with ac adapter
<b>Storage Temperature</b>	-20 °C to 70 °C
<b>Operating altitude</b>	10,000 meters above mean sea level (2,000 meters with ac Adapter)
<b>Relative Humidity (% RH operating without condensation)</b>	0 % to 90 % (non condensing)
<b>Vibration</b>	Random, 2g, 5–500 Hz
<b>Power requirements</b>	3 AA alkaline batteries 12 V dc universal power supply
<b>Size</b>	96 x 200 x 47 mm (3.75 x 7.9 x 1.86 inches)
<b>Weight</b>	0.65 kg (1.4 lb)
<b>Safety</b>	EN 61010-1:2001, CAN/CSA C22.2 No. 61010.1-04
<sup>†</sup> Environmental conditions for all specifications: 13 °C to 33 °C	

**Table 7** Millivolt Measurement

Range	Resolution	Accuracy
-10 mV to 75 mV	0.001 mV	± (0.005 % + 5 µV)
Temperature Coefficient ( -10 °C to 13 °C, +33 °C to 60 °C):		
± (0.001 %/°C + 1 µV/°C)		

**Table 8** Reference Junction Compensation

<b>Thermocouple Reference Junction Compensation Accuracy</b>
± 0.20 C

**Table 9** Ohms Measurement, RTDs

Ohms Range	Accuracy ± Ω 4 Wire
0 Ω to 400 Ω	± (0.004 % + 0.002 Ω)
Temperature Coefficient ( -10 °C to 13 °C, +33 °C to 60 °C):	
0.0008 %/°C + 0.0004 Ω	
Excitation Current: 1 mA	

**Table 10** Ohms Measurement, Thermistor

Ohms Range	Accuracy $\pm \Omega$ , 4 Wire
200 $\Omega$ to 50 k $\Omega$	$\pm (0.01 \% + 0.5 \Omega)$
50 k $\Omega$ to 500 k $\Omega$	$\pm (0.03 \%)$
Temperature Coefficient ( -10 °C to 13 °C , +33 °C to 60 °C):	
0.002 %/°C + 0.1 $\Omega$ (0 $\Omega$ to 50 k $\Omega$ )	
0.06 %/°C + 0.1 $\Omega$ (50 k $\Omega$ to 500 k $\Omega$ )	
Excitation Current:	10 $\mu$ A (0 $\Omega$ to 50 k $\Omega$ ) 2 $\mu$ A (50 k $\Omega$ to 500 k $\Omega$ )

**Table 11** Equivalent temperature accuracies derived from primary specifications ( $\Omega$ , mV)

Type	Range	Measure Accuracies (ITS-90)
B	600 °C to 800 °C	0.85 °C
	800 °C to 1000 °C	0.68 °C
	1000 °C to 1800 °C	0.57 °C
C	100 °C to 550 °C	0.32 °C
	550 °C to 2300 °C	0.71 °C
E	-200 °C to 0 °C	0.52 °C
	0 °C to 950 °C	0.22 °C
J	-200 °C to 0 °C	0.52 °C
	0 °C to 1200 °C	0.23 °C
K	-200 °C to 0 °C	0.61 °C
	0 °C to 1370 °C	0.24 °C
L	-200 °C to 0 °C	0.36 °C
	0 °C to 900 °C	0.23 °C
M	-20 °C to 0 °C	0.26 °C
	0 °C to 400 °C	0.25 °C
	400 °C to 1400 °C	0.22 °C
N	-200 °C to 0 °C	0.72 °C
	0 °C to 1300 °C	0.28 °C
R	-20 °C to 0 °C	1.09 °C
	0 °C to 500 °C	0.97 °C
	500 °C to 1750 °C	0.49 °C
S	-20 °C to 0 °C	1.05 °C
	0 °C to 500 °C	0.95 °C
	500 °C to 1750 °C	0.56 °C
T	-200 °C to 0 °C	0.60 °C
	0 °C to 400 °C	0.25 °C
U	-200 °C to 0 °C	0.54 °C
	0 °C to 400 °C	0.24 °C
<b>Resolution:</b> 0.01 °		
Note 1: Accuracies are based on internal Reference Junction Compensation..		

# 1523, 1524 Reference Thermometer

## Specifications

**Table 12** Temperature, Thermocouples External Reference Junction

Type	Range	Measure Accuracies (ITS-90)
B	600 to 800 °C	0.85 °C
	800 to 1000 °C	0.68 °C
	1000 to 1800 °C	0.57 °C
C	100 to 550 °C	0.32 °C
	550 to 2300 °C	0.71 °C
E	-200 to 0 °C	0.18 °C
	0 to 950 °C	0.09 °C
J	-200 to 0 °C	0.21 °C
	0 to 1200 °C	0.12 °C
K	-200 to 0 °C	0.31 °C
	0 to 1370 °C	0.15 °C
L	-200 to 0 °C	0.15 °C
	0 to 900 °C	0.11 °C
M	-20 to 0 °C	0.14 °C
	0 to 400 °C	0.14 °C
	400 to 1400 °C	0.14 °C
N	-200 to 0 °C	0.48 °C
	0 to 1300 °C	0.20 °C
R	-20 to 0 °C	1.06 °C
	0 to 500 °C	0.95 °C
	500 to 1750 °C	0.48 °C
S	-20 to 0 °C	1.03 °C
	0 to 500 °C	0.93 °C
	500 to 1750 °C	0.55 °C
T	-200 to 0 °C	0.30 °C
	0 to 400 °C	0.13 °C
U	-200 to 0 °C	0.27 °C
	0 to 400 °C	0.13 °C
<b>Resolution:</b> 0.01 °C		
<b>Note 1:</b> Accuracies are based on external reference junction compensation.		

**Table 13** Temperature, RTD Ranges and Accuracies (RTD-90)

Accuracy ± °C 4-wire Probe
± 0.011 at -100 °C
± 0.015 at 0 °C
± 0.019 at 100 °C
± 0.023 at 200 °C
± 0.031 at 400 °C
± 0.039 at 600 °C
Resolution: 0.001 °C (0.001 °F)

**Table 14** Temperature, Thermistor

Accuracy @ °C
± 0.002 at 0 °C
± 0.003 at 25 °C
± 0.006 at 50 °C
± 0.014 at 75 °C
± 0.030 at 600 °C
<b>Resolution:</b> 0.001 °C (0.001 °F)
Based on a 10kΩ (at 25 °C) thermistor with a beta value of 4000 Ω.

**Table 15** Fast Scan Mode Specifications

Probe Type	Times Normal specification
PRTs 0Ω to 400Ω	2
Thermocouples	2
Thermistors to 100K	5
Thermistors 100K to 500K	10

**Table 16** Sample Interval per Channel in Seconds

Probe Type	Normal Mode (sample rate set 1 second)		Fast Scan Mode (sample rate set to Auto)		Probe combination for two channel
	Channel 1	Channels 1 and 2	Channel 1	Channels 1 and 2	
PRT	1s	1.3s	0.45s	0.9s	PRT and PRT
Thermistor	1s	1s	0.3s	0.6s	Thermistor and Thermistor
Thermocouple	1s	1s	0.3s	0.6s	Thermocouple and Thermistor

## 1523, 1524 Reference Thermometer

### Specifications

---

**Table 17** Channel to Channel Differential Specifications

Probe Type	Times Normal specification
T1 – T2	1
T1 – T2 Fast Scan Mode	See Table “Fast Scan Mode Specifications”
<b>NOTE:</b> Specification is for $T1 - T2 < +/- 10\text{ }^{\circ}\text{C}$ . For Like Probes only. Accuracies do not include probe accuracies.	

## 3 General Operation

This section explains the details of the operation of the 1523/24 reference thermometer with its components and accessories.

### 3.1 Battery

The 1523/24 uses three (3) “AA” alkaline batteries that can power the instrument for 20 hours without replacement. The batteries will discharge more quickly if the backlight is used often. The battery icon will blink as the batteries approach depletion. When the battery icon is blinking, the user should replace batteries immediately to avoid affecting the accuracy of the instrument.

The batteries can be easily removed and replaced in the field by following this procedure:

1. Power the 1523/24 off and unplug the AC adapter from the unit.
2. Remove the yellow boot.
3. With the 1523/24 facing down, remove the screw and battery cover.
4. Remove the batteries.
5. Place new batteries into the unit.
6. Close the battery cover and replace the screw.
7. Replace the yellow boot.



**Warning:** *Used batteries must be disposed of properly. Check your local regulations for additional information. You may return used batteries to the manufacturer. Never dispose of batteries in fire as this may result in explosion with the possibility of personal injury or property damage.*

### 3.2 DC Power Source

The DC power source provides power to the 1523/24 reference thermometer. The AC adapter provided with the 1523/24 is intended to be used for this purpose. Use only the AC adapter supplied with the instrument. The DC power source plugs into the DC power input on the right side of the 1523/24.

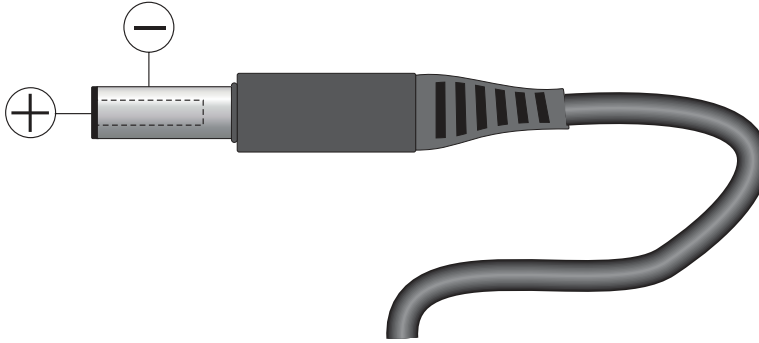

**Figure 15** 12V DC Power source Polarity



**Warning:** The AC adapter has circuits with high voltages inside that could present danger of electric shock or fire if exposed. If the AC adapter is damaged in any way or becomes hot, discontinue its use immediately, disconnect it from any AC supply, and have it replaced. Do not attempt to open, repair, or continue using a damaged or defective AC adapter

### 3.3 Probe

The probe is used to sense temperature. The 1523 is a single channel instrument and can measure using one probe. The 1524 is a dual channel instrument and can measure using two probes simultaneously. The probes attach to the 1523/24 using a Hart INFO-CON probe connector that plugs into the top of the instrument. The probe connector must be properly programmed with the correct characteristics of the probe for measurements to be accurate.

The 1523/24 can be used with various types of PRTs, Thermistors and Thermocouple probes:

- ITS-90 calibrated 25  $\Omega$  or 100  $\Omega$  PRT
- Callender-Van Dusen calibrated 100  $\Omega$  PRT,
- Steinhart-Hart thermistor R(T) polynomial; nominal R (25°C) 2K $\Omega$  to 100K $\Omega$ .
- Types B, C, E, J, K, L, M, N, R, S, T, U Thermocouples

The 1523 can measure PRT probes having 4 wires, thermistors, or thermocouples. The 1524 can measure PRT probes having 4 wires, and thermistors on either channel 1 or channel 2, and can measure thermocouples on channel 1 (only). Channel 2 on the 1524 cannot be used with thermocouples.



### 3.3.1 Internal or External reference junction compensation may be used with this instrument.

### 3.3.2 TC Internal Reference Junction

With internal reference junction compensation, the temperature of the Thermocouple connection is measured automatically and used to calculate the absolute temperature of the thermocouple. The infocon reference junction parameter must be programmed to Internal, and the external temperature parameter in the infocon will be ignored.

### 3.3.3 TC External Reference Junction

With External Reference junction compensation, the reference junction is held at a known fixed temperature. The value of the fixed temperature reference is used to calculate the absolute temperature of the thermocouple.

In this method, the reference junction is created externally and copper wires connect the reference junction to the 1523/24. The reference junction is placed in an ice bath or other temperature source that has a precisely known and stable temperature. This technique offers improved accuracy but is less convenient because of the more complicated connection scheme and the requirement of a precision temperature source.

The external reference temperature parameter and the external reference junction parameter must be set in the infocon connector prior to using this method.

Temperature is generally sensed at the tip of the probe. To get an accurate temperature measurement the probe sheath should be well immersed, with adequate depth and fit into the medium to be measured.



**Caution:** Probes are fragile devices that can be easily damaged by mechanical shock, overheating, and absorption of moisture or fluids in the wires or hub. Damage may not be visibly apparent but nevertheless can cause drift, instability, and loss of accuracy. Observe the following precautions:

- Do not allow probes to be dropped, struck, bent or stressed.
- Do not overheat probes beyond their recommended temperature range.
- Do not allow any part of the probe other than the sheath to be immersed in fluid.
- Do not allow the probe hub or wires to be exposed to excessive temperatures.
- Keep the probe wires clean and away from fluids.

## 3.4 Probe Lock Function

The 1523 may be locked for exclusive operation with a specific probe, for quality control purposes, and each channel of the 1524 may be locked with its own unique probe. Locking the probe also prevents use with other readouts, until the probe is unlocked.

To set the probe lock, plug in the probe to the channel that you want to lock it to. First send the unit password enable command, SYST:PASS:CEN XXXX (where xxxx is the unit password) through the serial port using the 9940 software or a terminal program.

Then send the serial command CALx:DEV:LOCK 1 to the unit, where x is the channel that the probe is connected to.

To unlock a probe send the SYST:PASS:CEN XXXX (where xxxx is the unit password). Then send the command, CALx:DEV:LOCK 0

Any unit can unlock a locked probe. The 9940 software can read in a locked probe's data.

If the probe lock is on and a different probe is attached to the unit or channel the display will show "LOCKED". Measuring is disabled.

If probe lock is off, the instrument can be used with any probe. Refer to the Digital Communication Interface section of this manual

### 3.5 INFO-CON Connector

The probe(s) connects to the top of the 1523/24 reference thermometer using a Hart INFO-CON connector. The probe connector will fit snugly and lock into place when it is fully inserted. The connector includes a memory device that stores the unique characteristics of the probe, allowing the instrument to measure temperature accurately. Generally the probe will be purchased with the connector attached and programmed by the factory. Connectors can be purchased separately and installed on probes by the user. The INFO-CON can be programmed directly from the 1523/24 by authorized personnel using the serial port commands or the 9940 software (see Section 6, Digital Communication Interface on page 43).

If it is necessary to connect an INFO-CON connector to a probe in the field, follow the diagram below for connecting the wires of the probe to the connector terminals. Before opening the INFO-CON case, be sure to be grounded with an ESD strap to avoid damaging the memory chip. If a shield wire is present it should not be connected.

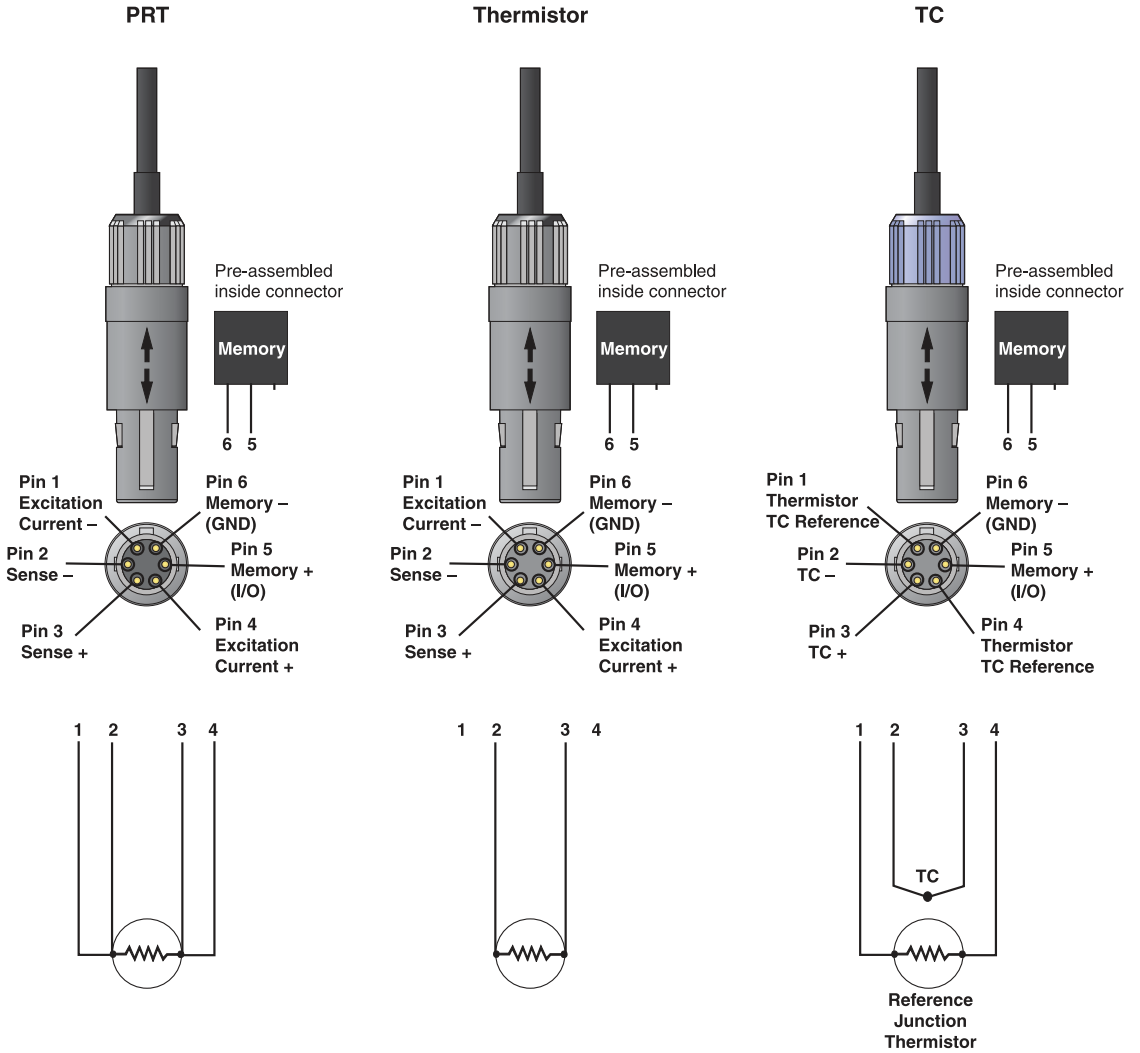

**Figure 16** Probe wiring diagrams



## 4 Display Functions and User Interface

This chapter discusses in detail how to operate the Reference Thermometer using the front panel keys and liquid crystal display (LCD). This includes reading temperature(s) in °C or °F, viewing statistics, using the auxiliary display for differential temperature (T1-T2) or electrical readings ( $\Omega$ , mV), capturing up to 25 discrete data readings with statistics, logging up to 15,000 readings at selected time intervals, and configuring the communication interface. Refer to the full menu structure diagram in the previous section.

### 4.1 Main Screen

The LCD on the front panel allows direct viewing of the temperature readings, auxiliary reading, statistics (MIN, MAX, AVE, and STDDEV), or a graphical representation of the temperature reading over time with the temperature or stats for the temperature above the graph. The temperature displayed is either in °C or °F, and is easily changed by pressing the °C °F key on the front keypad. The main displayed value is the temperature reading from the probe. The auxiliary reading is the value displayed based on the user options from the SETUP menu and includes the reading in ohms, mV, Delta X, T1 – T2, or T2 – T1, or the reference junction temperature if a thermocouple is used. The main screen will also show the menu items and selections when a menu related key is pressed. The following sections describe the keys and menu functions.

### 4.2 STATS

The STATS key allows the user to view the minimum, maximum, average, and the standard deviation of the readings on each channel. When using this feature, press the STATS key to enter this mode. Press the STATS key again to toggle through the statistics options, MAX, MIN, AVE, and STDDEV. The results of the selection are shown in the main numeric display. If the user enters into the graphing mode, the results of the selection will be displayed across the top of the graph in the smaller characters. When using this feature on the 1524 dual channel instrument, both of the channels will display the same selection, MIN, MAX, AVE, or STDDEV. The user is unable to select different statistics options for each channel. Press the RESET or HOME keys to exit the STATS mode.

### 4.3 °C °F

The °C °F key allows the user to quickly change between units. In the main numeric screen, this key will toggle the units in both the main and auxiliary display values. In graphing mode, the unit change will cause the graph to refresh. Select units prior to starting a graphing session. Units are displayed and recorded with temperature readings, auxiliary readings, and logged data.

### 4.4 HOLD

This mode is identified by “HOLD” which appears on the bottom center of the display.

In this mode the data stored and displayed last remains on screen, this includes statistics information. Press the HOLD or HOME keys to exit the hold mode.

## **4.5 SETUP**

The SETUP key accesses the SETUP Menu and allows access to Channel T1 Setup submenus, Channel T2 Setup submenus (1524 only), Instrument setup, and the Date/Time (1524 only) submenus. The submenus allow the user to configure the instrument and its system parameters.

### **4.5.1 Channel T1**

Select the Channel T1 submenu by pressing the ENTER key. This menu allows the user access to view the probe data from the INFO-CON connector and to setup the auxiliary display for channel T1.

#### **4.5.1.1 Probe**

This is a read only field; it tells the user the probe and/or the conversion type used with the related probe.

#### **4.5.1.2 Config**

This is a read only screen, when accessed by pressing the ENTER key, the user can view all of the setup information retained in the INFO-CON connector. This information tells the user the conversion type, serial number, calibration date, all of the coefficients used for this probe, reference junction type (internal or external) if the probe is a thermocouple, and the Min and Max temperatures allowed for the probe.

#### **4.5.1.3 Base X**

This is the reference value used by the DeltaX function in the auxiliary display. DeltaX calculates the difference between the current reading and Base X.

#### **4.5.1.4 Aux Displ**

This is the Auxiliary display selection. In addition to temperature on the main numeric output, the user may choose to display an auxiliary measurement for channel T1. For a resistance thermometer, the user may select to display Ohms, DeltaX, (T1-T2), or None.

If this display feature is for a thermocouple, the user may choose to display RJ Temperature, mV, (T1-T2), DeltaX or None.

##### **4.5.1.4.1 Ohms**

This mode is identified by “ $\Omega$ ” along the top of the screen. In this mode, the resistance in Ohms for the temperature measurement appears on the top of the display. This option is available when the selected channel is reading PRTs or thermistors.

**4.5.1.4.2 mV**

This mode is identified by “mV” along the top of the screen. In this mode, the voltage reading in mVs for the temperature measurement appears on the top of the display. This option is available when the selected channel is reading thermocouples.

**4.5.1.4.3 RJ Temp**

This mode is identified by “RJ” along the top of the screen. In this mode, the reference junction temperature reading appears on the top of the display. This option is available when the selected channel is reading thermocouples and the reference junction is set to Internal.

**4.5.1.4.4 DeltaX**

This mode is identified by “ $\Delta X$ ” along the top of the screen. In this mode, the difference (delta) between the measurement and a previously stored reference value (Base X) appears on the top of the display.

**4.5.1.4.5 T1-T2**

This mode is identified by “ $\Delta T$ ” along the top of the screen in the T1 row. In this mode, the difference between the channel T1 reading and the channel T2 reading is shown on the top of the display in the first row. This mode is only available in model 1524.

**4.5.1.4.6 None**

In this mode, nothing is displayed in the auxiliary display area.

**4.5.1.5 Temp Res**

The Temperature Resolution may be changed from 0 to 3 decimal places when using a resistance thermometer. A maximum of two decimal places is allowed if using a thermocouple probe.

**4.5.1.6 RJ**

Thermocouple reference junction compensation may be either internal or external, depending whether the thermocouple has an external reference junction or not. Reference junction temperatures for the external type may be entered through the display. Reference junction temperatures for internally compensated thermocouples can be shown on the auxiliary display. The reference junction type will be identified in the INFO-CON connector for the specific thermocouple and can only be edited through the serial port.

**4.5.2 Channel T2 (1524 Only)**

Select the Channel T2 submenu by pressing the ENTER key. This menu allows the user access to view the probe data from the INFO-CON connector and to setup the

auxiliary display for Channel T2. Channel T2 is only used for PRTs and thermistors. This channel can not be used for thermocouples. This Submenu is available in model 1524 only.

#### 4.5.2.1 Probe

This is a read only field; it tells the user the probe and/or the conversion type used with the related probe.

#### 4.5.2.2 Config

This is a read only screen, when accessed by pressing the ENTER key, the user can view all of the setup information retained in the INFO-CON connector. This information tells the user the conversion type, serial number, calibration date, all of the coefficients used for this probe, and the Min and Max temperatures allowed for the probe.

#### 4.5.2.3 Base X

This is a reference value that may be stored in the unit for use as a comparison or difference value from the current reading when using the DeltaX auxiliary display.

#### 4.5.2.4 Aux Displ

This is the Auxiliary display selection. In addition to temperature on the main numeric output, the user may choose to display an auxiliary measurement for channel T2. For a resistance thermometer, the user may choose to display Ohms, DeltaX, (T2-T1), or None.

##### 4.5.2.4.1 Ohms

This mode is identified by “ $\Omega$ ” along the top of the screen. In this mode, the resistance in Ohms for the temperature measurement appears on the top of the display. This option is available when the selected channel is reading PRTs or thermistors.

##### 4.5.2.4.2 T2-T1

This mode is identified by “ $\Delta T$ ” along the top of the screen in the T2 row. In this mode, the difference between the Channel T2 reading and the Channel T1 reading is shown on the top of the display. This mode is only available in Channel T2 on model 1524.

##### 4.5.2.4.3 DeltaX

This mode is identified by “ $\Delta X$ ” along the top of the screen. In this mode, the difference (or delta) between the measurement and a previously stored reference value (Base X) appears on the top of the display.



**4.5.2.4.4 None**

In this mode, nothing is displayed in the auxiliary display area.

**4.5.2.5 Temp Res**

The Temperature Resolution may be changed from 0 to 3 decimal places if using a resistance thermometer, or a maximum of two decimal places if using a thermocouple probe.

**4.5.3 Instrument**

The instrument menu allows the user access to the serial port setup, unit Auto-Off timer, backlight timer, contrast and the fast scan rate mode. The Auto-Off timer and backlight timer are power saving settings for use when operating on battery power.

**4.5.3.1 Fast Scan Mode**

This mode allows the user to increase the sample rate in the instrument. When this mode is used, the sample rate is increased at the expense of the accuracy. The instrument specifications are only guaranteed when the Fast Scan Mode is turned off. Refer to alternate specifications for operating in Fast Scan mode. This setting is not stored in the memory and is reset to off at power up.

**4.5.3.2 Contrast**

This is an incremental setting selection that enables the user to change the screen contrast. An increase in value results in a darker contrast. A decrease in value results in a lighter contrast.

**4.5.3.3 Auto-Off**

This timer setting tells the unit how long to stay on before shutting down. Allowable settings Range from 1 to 30 minutes or the user may turn this feature Off. If the unit turns off, this feature will terminate the graphing mode and auto logging mode when shutting down. The user will need to press the POWER key in order to restart the unit.

**4.5.3.4 Backlight Time**

This timer setting tells the unit how long to keep the back light illuminated before shutting down. Allowable settings range from 1 to 30 minutes or the user may turn this feature Off.

**4.5.3.5 Serial Port**

This feature allows the user to turn the serial port On or Off. This is a battery saving feature and is recommended when operating on battery power and when direct uploading to a PC is not required. Data may be gathered in the Demand Log or Auto-Log modes prior to turning on the serial port and uploading the information.

#### 4.5.3.6 Baud Rate

This feature allows the user to change the baud rate from 9600 (default) or 2400 baud.

#### 4.5.3.7 Date/Time

This feature allows the user to change or adjust the Time and Date. The time and date is recorded on all Log files saved. This feature is only available on model 1524.

##### 4.5.3.7.1 Date

The date feature allows the user to adjust the month, day and year in an YYYY/MM/DD format. The date can be adjusted by using the up and down arrow keys while in the date field, and pressing the ENTER key to save the change. The cursor will highlight the year <YYYY> field when entering into this screen. Use the up and down arrow keys to adjust the year. Press the ENTER key to save the change and advance to the month <MM> field. Adjust the months in the same manner and press the ENTER key when complete. This will advance the cursor to the next field, days <DD>. Change the days field to the correct day in the same manner and press the ENTER key when complete. This feature is only available on model 1524.

##### 4.5.3.7.2 Time

The time feature allows the user to adjust the HH/MM/SS in 24 hour format. The time can be adjusted by using the up and down arrow keys while in the time field, and then pressing the ENTER key to save the change. The cursor will highlight the hour <HH> field when entering into the time fields from the date fields. Use the up and down arrow keys to adjust the hour. Press the ENTER key to save the change and advance to the min <MM> field. Adjust the minutes in the same manner and press the ENTER key when complete. This will advance the cursor to the next field, seconds<SS>. Change the seconds field to the correct second in the same manner and press the ENTER key when complete. This feature is only available on model 1524.

## 4.6 SAVE

A point is saved into the demand log when the SAVE key is pressed while in the numeric or graphic display mode. Up to 25 points may be stored using the demand log.

When the SAVE key is pressed, the bottom row of the display will indicate that a save has occurred with a tag ID "SAV01" (followed by a date and time if model 1524). If there are 25 points already stored, SAV FULL (save full) will be displayed for 3 seconds and no new data will be recorded.

## 4.7 ARROWS, UP, DOWN

The up and down arrow keys allow the user to select options within a field indicated by an up and down arrow indicator to the right or left of the field.

## **4.8 ENTER**

The ENTER key is used to select a menu option, accept a setting change, configuration change, or enable a logging session.

## **4.9 RECALL**

The 1523/24 has a Demand Log that stores up to 25 readings that may be displayed on screen or sent out the serial port to a computer. The RECALL menu allows the user to review, delete, or send demand log data out the serial port.

The 1524 has an Auto-Log with the added capability of storing up to 15,000 readings with a time and date stamp on each reading. The readings can be sent to a computer or deleted using this menu.

### **4.9.1 Review Saved**

This menu displays one of up to 25 saved readings on main screen for review. The display shows channel, auxiliary display value, main display value, tag id and time stamp if model 1524. The user can scroll through each log by pressing the up and down arrow keys. The user can exit this review mode by pressing the RECALL or the HOME (SHIFT + ENTER) keys.

### **4.9.2 Send Saved**

This feature sends the entire demand log out the serial port to a computer. When all of the data is sent, the display will show “100%” to the right of the Send Saved command selection to indicate that the send function is complete. This does not affect the stored data. Refer to the Demand Log, and Digital Communications Interface section of this manual for more information.

### **4.9.3 Delete Saved**

This feature allows the user to delete data files saved in the Demand Log. The user may delete a specified file or all files. Use the Up and Down arrow keys to select the file to delete. The instrument default is used to delete all files. The user can exit this menu and return to the main display by pressing the RECALL or HOME (SHIFT + ENTER) key(s).

### **4.9.4 Send Logs**

This feature allows the user to send logged data files out the serial port to a computer. In order to use this feature the user must turn the serial port on, and set the baud rate to the appropriate setting. Refer to Section 5.2, AUTO-LOG on page 39, and Section 6, Digital Communication Interface on page 43 for more information. This feature is available on model 1524 only.

#### **4.9.5 Delete Logs**

This feature allows the user to delete logged data files. The user may delete a specified file identified by the Tag ID, or all files. Use the up and down arrow keys to select the file to delete. The instrument default is to delete all files. The user can exit this menu and return to the main display by pressing the RECALL or HOME (SHIFT + ENTER) key(s). This feature is available on model 1524 only.

#### **4.10 NEXT**

The NEXT key is used to move from field to field in the menu.

#### **4.11 SHIFT**

This feature allows the user to use second function keys (identified in yellow) on the keypad. Following a press of the shift key, “SHIFT” will be displayed on the lower right side of the display. When in the “TREND” mode with a graph displayed, the “SHIFT” will be displayed on the upper left area of the display. Pressing the “SHIFT” key a second time eliminates the second function request.

#### **4.12 RESET**

The RESET key (SHIFT + STATS) is used to exit the STATS mode. Upon exiting the STATS mode the minimum, maximum, average and standard deviation values are reset.

#### **4.13 $\Omega$ mV**

The  $\Omega$  mV key (SHIFT + °C °F) switches the main numeric display from degrees to ohms/mV or ohms/mV to degrees. This feature allows the user to select between the reading in base units (ohms or millivolts) and the reading converted to temperature.

#### **4.14 TREND**

The TREND key (SHIFT + HOLD) switches from numeric to graphic mode, or from graphic to numeric mode. This feature provides the user with a convenient visual display of temperature over time by graphing the data in a temperature vs. time plot. This may be used to assess settling time, stability, disturbances, or oscillations. This feature is affected by the Auto-Off function. If the Auto-Off function is used and the unit turns off during graphing, the graph will be terminated and the unit will restart in numeric mode. It is recommended that the Auto-Off function be turned off before starting a graphing session.

The time scale is displayed on the horizontal axis and is not adjustable. The time scale is fixed at 6 seconds per reading, allowing up to 10 minutes of data to be shown on the graph. When the graph extends to the far right of the screen, the graph will scroll to the left about 25% of the screen and continue plotting.

The temperature scale is displayed on the vertical axis and is adjustable up to 4 orders of magnitude. The display range is shown on the left side of the vertical axis and is ad-

justed using the UP and DOWN ARROW keys to increase or decrease the scale range. The available range selections are +/- 0.01, +/-0.1, +/-1.0, +/- 10.0 °C. The vertical scale center is calculated automatically and displayed.

The graphing function may be used on models 1523 and 1524. The 1523 will always display Channel T1. When using the 1524 instrument, Channel T1 is selected by default, the user may select between Channel T1 and Channel T2 by pressing the “NEXT” key. In this mode, data for both Channel T1 and Channel T2 graphs are maintained simultaneously. Only one channel may be displayed at a time while the other channel is held in memory. When a channel is switched, the graph is replaced with data from the new channel.

While in the graphing mode, the channel being displayed is shown on the top left area of the display, ‘T1’ or ‘T2’. The top right area of the display shows the statistical option, followed by the statistical value for the displayed channel in numeric format. The most recent temperature measurement is displayed in numeric format above the graph and just below the stats value. The statistical option selection may be changed by pressing the “STATS” key until the desired option (MIN, MAX, AVE, or STD) appears on the display. Note: Standard deviation will be shown on the screen in this mode as STD rather than the usual STD DEV.

The graph is cleared when the display mode is changed to or from a numeric format, or if the temperature units are changed. In addition, entering in the SETUP Menu will cause the graph to refresh.

## **4.15 LOG**

The Auto-Log feature allows the user to setup data collection and storage on both channels. This menu selection allows the user to setup the interval of the logged data, a tag or identification label, see the available memory for storage, and session start & stop. This Auto-Log feature is only available in model 1524.

The Auto-Log feature is affected by the Auto-Off function. If the Auto-Off function is used and the unit turns off during a logging session, the logging session will be terminated and the unit will restart with the Auto-Log turned off. It is recommended that the Auto-Off function be turned Off before starting a logging session.

### **4.15.1 Free**

This feature indicates the amount of memory available for storage, in terms of % memory unused. It also indicates how many bytes of memory are available for use.

### **4.15.2 Interval**

This feature allows the user to select the interval used by the processor to take new data. The available selections are Auto, 1, 2, 5, 10, 30 and 60 seconds. If logging with a model 1524 using two active probes and a 1 second interval, a second of data will be skipped approximately every three seconds in order to have unique values in every set of stored data. When the unit is in Auto interval sampling, the Fast Scan Mode Specifications apply. Refer to Table 15 on page 21, Fast Scan Mode Specifications and Table 16 on page 21, Sample Interval per Channel in Seconds

**4.15.3 Tag**

This is a label attached to the stored data set. The tag name may be changed by the user using the serial interface port. This name can be 8 alpha numeric characters long.

**4.15.4 Session**

This feature is used to start or stop logging sessions. Only the available condition (START or STOP) can be selected.

**4.16 HOME**

The HOME key (SHIFT + ENTER) allows the user to return to the main screen from anywhere in the menu.

## 5 LOGS

There are two log features associated with models 1523/1524, the Demand Log and the Auto-Log. Both the 1523 and 1524 have a demand log that stores up to 25 readings. The 1524 has an Auto-Log that can store up to 15,000 readings at specified intervals. The Auto-Log feature is affected by the Auto-Off function. If the Auto-Off function is used and the unit turns off during a logging session, the logging session will be terminated and the unit will restart with the Auto-Log turned off. It is recommended that the Auto-Off function be turned off before starting an Auto logging session.

### 5.1 DEMAND LOG

This feature is used to log and recall up to 25 points. A point is logged using the SAVE key. Logged data is saved in memory and is retained after the unit is turned off. The data can be uploaded to a computer using the Send Saved command in the RECALL Menu, or by remote commands issued through the serial port. Refer to the Digital Communications Interface section of this manual for more information on the serial commands.

Each logged data point contains the following data:

- Current reading with units of measure
- Current statistics, including maximum, minimum, average, and standard deviation.
- User selected secondary readings, including units.
- Time stamp including year, month, day, hour, minute and second (model 1524 only).

### 5.2 AUTO-LOG

This feature is used to log and store up to 15,000 points. A point is logged on a predetermined frequency based on the LOG Menu settings. Logged data is saved in memory and is retained after the unit is turned off. The data can be uploaded to a computer using the Send Logs command in the RECALL Menu, or by remote commands issued through the serial port. Refer to the Digital Communications Interface section for more information on the serial commands.

The LOG key allows the user to access the LOG setup menu. The Log menu allows the user to setup the data collection interval, start a log with a specified Tag ID, see the available memory, and START or STOP a logging session. The RECALL menu allows the user to delete, or send log data out the serial port.

Refer to the Digital Communications Interface section for information on changing Tag IDs or using the computer interface.

#### 5.2.1 Auto-Log Operation

A log session is configured and started or stopped by pressing the LOG key (SHIFT + SAVE). The following screen is displayed:

```
Free: nn% rrrr  
Interval: tt sec. (or Auto)
```

Tag: vv, xxxxxxxx \*  
“yy/mm/dd hh:mm:ss” or “No Data”  
Session: START (or STOP)

Where:

Free: indicates the percentage of unused memory (nn), and the total number of records that can be stored before it becomes full (rrrrr), and automatically stops.

Interval: is the logging interval (tt) expressed in seconds. The choices are Auto, 1, 2, 5, 10, 30, and 60. 10 seconds is the default for a new log. Note: When the unit is Auto interval sampling, the Fast Scan Mode Specifications apply. Refer to Table 15 on page 21, Fast Scan Mode Specifications and Table 16 on page 21, Sample Interval per Channel in Seconds

Tag: is an alpha-numeric identifier (vv) from 1 to 25, followed by a Tag ID (xxxxxxx). The default Tag ID names are DATA\_01 to DATA\_25 or the user specified eight character tag name. If the tag has stored data, an asterisk (\*) will follow the tag name and the following line will contain the time stamp (Date followed by Time). If the tag contains no data, “No Data” will be shown on the line following the Tag name.

*Note: the user specified Tag can only be updated through serial communications through the serial port. Refer to Section 6, Digital Communication Interface on page 43.*

Session: START will be displayed when logging is not in use, STOP will be displayed when logging is in use.

If logging is not in use when Auto-Log is selected, the user may change the interval and Start the logging session. If a logging session is in use, the user may choose to stop the session; no other actions may be performed by the user in this menu window.

The user may exit this screen without performing an action by pressing the LOG key (SHIFT + SAVE) or the HOME key (SHIFT + ENTER).

Once an Auto-Log is started, the present primary value and the units for each channel in use are stored at the selected interval. The lower line on the main screen shows the log status as follows:

LOG n hh:mm:ss

Where n is the number of data points currently logged into the selected Tag ID, and hh:mm:ss is the elapsed time since the log session started.

The update is in the selected interval of the logging session. For example, if the session has a 10 second log interval, the update on the main screen will also be in 10 second intervals.

When the log storage is full, the lower line on the main screen will change to “LOG Full” and will remain until the user turns off the logging session by pressing the LOG key (SHIFT + SAVE) and pressing ENTER to stop the session.



*Note: If logging with a model 1524 using two active probes and a 1 second interval, a second of data will be skipped approximately every three seconds in order to have unique values in every set of stored data. When the unit is in Auto interval sampling, the Fast Scan Mode Specifications apply. Refer to Table 15 on page 21, Fast Scan Mode Specifications and Table 16 on page 21, Sample Interval per Channel in Seconds*

### 5.2.2 Sending Auto Log Data to a Computer

The data from one or all tags can be sent out the serial port to a computer. In order to send data out the serial port, the instrument must be in the main numeric screen, and the logging session must be turned off (no logging or graphing). The user may then press the RECALL key and press the NEXT key to highlight the Send Logs selection, then press ENTER.

The next menu screen will allow the user to select a specific Tag ID to download or choose to down load All tags. Use the up and down arrow keys to make selection.

### 5.2.3 Data Upload Format

Each data line includes the default or the user defined Tag ID, the channel number, the primary value with units, and time and date. Note: The time stamp is available on model 1524 only. If only one channel is active during the logging session, only the data for the active channel will be sent through the serial port. If both channels are active, the records for each channel will alternate on the output. The output format is shown in the following example for a two channel output:

```
DATA_25,1, 22.676, C, 15:19:42,2008-05-24  
DATA_25,2, 23.245, C, 15:19:44,2008-05-24  
DATA_25,1, 23.220, C, 15:19:46,2008-05-24  
DATA_25,2, 23.260, C, 15:19:48,2008-05-24  
DATA_25,1, 22.765, C, 15:19:50,2008-05-24  
DATA_25,2, 23.263, C, 15:19:52,2008-05-24
```

Each data field is comma delimited, and each record is terminated with a carriage return (CR) and a new line (LF) command. For more information on the serial interface protocols, see the Digital Communications Interface section.

### 5.2.4 Deleting Auto Log Data

This feature allows the user to delete logged data files by selecting Delete Logs in the RECALL menu. The user may delete a specified file, identified by the Tag ID, or select All files. Use the Up and Down arrow keys to select the file to delete. The instrument default is to delete All files. Once the user has selected the data files to delete, press ENTER to delete the file. The instrument will request the user to confirm deletion and the user must press ENTER again to delete, or press NEXT to cancel the request. The user can exit this menu and return to the main display by pressing the RECALL or HOME (SHIFT + ENTER) key(s) at any time. This feature is available in model 1524 only.



## 6 Digital Communication Interface

The 1523/24 handheld readout is capable of communicating with and being controlled by an external device through the RS-232 digital interface.

With a digital interface, the instrument may be connected to a computer. This allows the user to obtain measurement data and control operating conditions. The RS-232 serial interface allows serial digital communications over fairly long distances. With the serial interface, the user may access any of the functions, parameters and settings discussed in this section. The 9940 software that came with the unit is available to assist in the communications interface. Refer to the documentation included on the software CD for additional information.



### *Special Note on Using grounded and bare junction thermocouples with RS-232:*

Special precautions should be taken when using RS-232 communications with the 1523/24 and a grounded thermocouple or bare junction thermocouple. A grounded thermocouple has its measurement junction electrically connected to a conductive sheath and a bare thermocouple has an exposed measurement junction. Both thermocouple configurations may expose the circuit to potential ground loops and electrical interference when the 1523/24 is connected to a personal computer through an RS-232 cable. The effect may vary from setup to setup depending on the computer and the overall system.

Ground loops and electrical interference may result in inaccurate measurements if proper precautions are not taken. These precautions involve breaking an undesired electrical connection to ground or to the computer. The following are examples of precautions that may be taken:

1. Use the 1523/24 demand log and auto log functions to avoid connecting to a computer when using grounded junction or bare junction thermocouples. Once the readings are complete, connect the RS-232 cable and upload the data to the personal computer.
2. Use an optically coupled isolator that is connected between the personal computer and the RS-232 cable to the 1523/24. The Isolator breaks the electrical ground loop by only communicating data, using light. Refer Section 1.8 for contact information to purchase the Isolator or if you have any further questions.
3. Use a laptop computer running on its battery without an AC adapter. This may provide enough isolation to minimize the grounded thermocouple measurement errors. The user should test this scenario by taking measurements with and without the RS-232 cable connected to the 1523/24.

### 6.1 Wiring

The serial communications cable attaches to the instrument through the 1/8" mini-jack connector at the top of the instrument. To reduce the possibility of electrical interface,

the serial cable should be shielded with low resistance between the connector and the shield. It should not be much longer than is necessary. Data Upload Format

Each data field is comma delimited, and each record is terminated with a carriage return (CR) and a new line (LF) command.

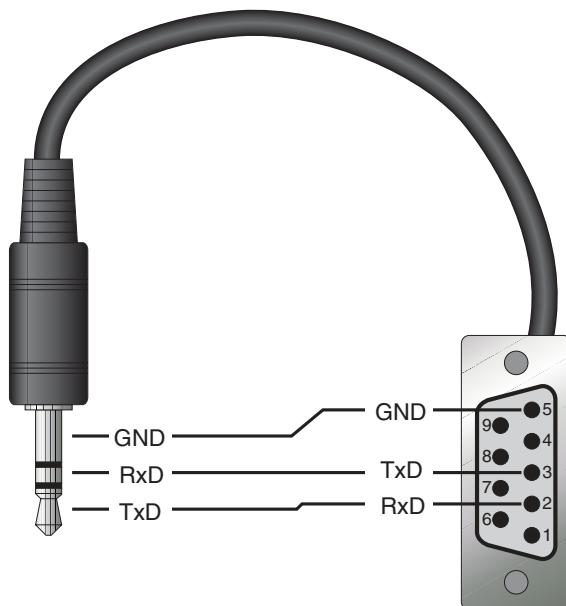

*Figure 17 RS-232 wiring*

### 6.1.1 Setup

Before operation, the serial interface must first be set up by turning on the serial port and programming the BAUD rate. This can be accessed from the main menu by selecting SETUP Instrument.

### 6.1.2 Serial Operation

The serial communications uses 8 data bits, one stop bit, and no parity. The baud rate is set to 9600 as the default. The user can also select 2400 baud.

### 6.1.3 Data Upload Format

Each data field is comma delimited, and each record is terminated with a carriage return (CR) and a new line (LF) command.

## 6.2 Command Syntax

The instrument accepts commands for setting parameters, executing functions or responding with requested data. These commands are in the form of strings of ASCII-

encoded characters. As far as possible, the 1523/24 command syntax conforms to IEEE-488.2 1992, SCPI 1999, with the following exceptions:

Compound commands, separated by semicolons, are not allowed.

Overlapped commands are not supported.

Processing of commands is sequential, and each command is completed before continuing to the next command.

Probe parameters may only be queried and set on one per command basis. There is insufficient memory available to accommodate the potentially long command strings possible with multiple parameters per command.

The MIN, MAX, DEF, and ALL data entry options are not generally allowed.

Parsing is based only on the first 3 or 4 significant letters of a keyword, all subsequent letters up to the next colon, space, or suffix number are ignored. The significant letters are shown in upper case.

All commands and parameters are case insensitive. Lower case letters are changed to upper case before processing.

Null commands (terminator only received) are ignored.

The receive buffer capacity is 96 characters after which an over run error is queued and the buffer contents are ignored. Short form command mnemonics are shown in upper case letters, with the additional letters required for the long form appended in lower case. Either form is permitted.

Many commands have a mnemonic suffix, or parameter value, of 1 or 2 to specify the probe number addressed by the command. If a command with a value of 2 is used on a 1523, which has only one probe, a command error occurs and the command is ignored.

### **6.3 Serial Commands by Function or Group**

In this section, the commands are arranged into the following groups:

Data Logging Commands – commands to report and setup the logging data.

Calibration and Setup Commands – commands to setup the calibration of the instrument

Measurement Commands – commands to report and setup the measure parameters of the instrument.

Probe Setup Commands – commands to report and setup probe information.

Status and Event Commands – commands to report and setup the status of the instrument.

System Commands – commands to report and change the system information, communication, and password of the instrument.

# 1523, 1524 Reference Thermometer

## Serial Commands by Function or Group

**Table 18** Commands by Function or Group

Functions or Groups	SCREEN PARAMETER	Command	Password Protection Group	Read/Write
Data Logging - Automatic	Tag	LOG:AUT:DEL <num>	N/A	W
	(none)	LOG:AUT:FREE?	N/A	R
	(none)	LOG:AUT:LAB?	N/A	R
	(none)	LOG:AUT:LAB <num>	N/A	W
	(none)	LOG:AUT:POIN?	N/A	R
	(none)	LOG:AUT:PRIN <num>	N/A	R
	SESSION	LOG:AUT:STAT?	N/A	R
	SESSION	LOG:AUT:STAT <bool>	N/A	W
	INTERVAL	LOG:AUT:TIM?	N/A	R
	INTERVAL	LOG:AUT:TIM <rate>	N/A	W
	TAG	LOG:AUT:VAL? <num>	N/A	R
Data Logging - Common	TAG	LOG:LAB<n>:NAME?	N/A	R
	TAG	LOG:LAB<n>:NAME <label>	N/A	W
Data Logging - Demand	(none)	LOG:DEM:DEL	N/A	W
	(none)	LOG:DEM:FREE?	N/A	R
	(none)	LOG:DEM:POIN?	N/A	R
	(none)	LOG:DEM:PRIN	N/A	R
	(none)	LOG:DEM:VAL? <num>	N/A	R
	(none)	LOG:DEM:STAT<n>? <num>	N/A	R
Display	TEMP:RES	DISP<chn>:RES?	N/A	R
	TEMP:RES	DISP<chn>:RES <num>	N/A	W
	UNITS	UNIT:TEMP?	N/A	R
	UNITS	UNIT:TEMP <unit>	N/A	W
Calibration & Setup	(none)	CAL:DEV:AUTO?	N/A	R
	(none)	CAL:DEV:AUTO <val>	N/A	W
	(none)	CAL<chn>:DEV:LOCK?	N/A	R
	(none)	Cal<chn>:DEV:LOCK <bool>	Conditional*	W
	(none)	CAL<chn>:DEV:LOCK:DATA?	N/A	R
	(none)	CAL<chn>:DEV:RANG:ADJ<num>?	N/A	R
	(none)	CAL<chn>:DEV:RANG:ADJ<num> <val>	Conditional*	W
	(none)	CAL<chn>:DEV:RANG:CLEA	Conditional*	W
	(none)	CAL<chn>:DEV:RANG:NUM	N/A	R
	(none)	CAL<chn>:DEV:RANG:NUM <val>	Conditional*	W
	(none)	CAL<chn>:DEV:RANG:REF<num>?	N/A	R
	(none)	CAL<chn>:DEV:RANG:REF<num> <val>	Conditional*	W
	(none)	CAL<chn>:DEV:RANG:SEL?	N/A	R
	(none)	CAL<chn>:DEV:RANG:SEL <val>	N/A	W

Functions or Groups	SCREEN PARAMETER	Command	Password Protection Group	Read/Write
Measurement	(none)	CALC:AVER:CLE	N/A	W
	(none)	CALC<prb>:AVER<n>:DATA?	N/A	R
	(none)	CALC:AVER<n>:TYPE?	N/A	R
	(none)	FETC? <prb>	N/A	R
	(none)	MEAS? <prb>	N/A	R
	(none)	READ? <prb>	N/A	R
	(none)	SENS:DATA:MV?	N/A	R
	(none)	SENS<prb>:DATA:OHMS?	N/A	R
	(none)	SENS:DATA:RJ?	N/A	R
	RJ	SENS:RJ:STAT?	N/A	R
	(none)	SENS:RJ:TEMP?	N/A	R
	(none)	SENS:RJ:TEMP <val>	N/A	W
Probe Setup	DATE	CALC<prb>:CONV:DATE:CAL?	N/A	R
	DATE	CALC<prb>:CONV:DATE:CAL <year>.<month>.<day>	Conditional*	W
	(none)	CALC<prb>:CONV:NAM?	N/A	R
	(none)	CALC<prb>:CONV:NAM <conv>	Conditional*	W
	(none)	CALC<prb>:CONV:PAR:CAT?	N/A	R
	(none)	CALC<prb>:CONV:PAR:VAL? <param>	N/A	R
	(none)	CALC<prb>:CONV:PAR:VAL <param>,<num>	Conditional*	W
	(none)	CALC<prb>:CONV:SNUM?	N/A	R
	(none)	CALC<prb>:CONV:SNUM <seri>	Conditional*	W
	(none)	CALC<prb>:CONV:TEST? <res> <mv>[,<rt>]	N/A	R
	(none)	CALC:CONV:UPD	N/A	W
	(none)	CALC<prb>:CONV:IDEN?	N/A	R
	(none)	CALC<prb>:CONV:IDEN <num>	Conditional*	W
	(none)	CALC<prb>:CONV:VERS?	N/A	R
	(none)	CALC<prb>:CONV:VERS <num>	Conditional*	W
Status & Event	(none)	*RST	N/A	W
	(none)	STAT:MEAS:EVEN?	N/A	R
	(none)	STAT:MEAS:COND?	N/A	R
	(none)	STAT:MEAS:ENAB?	N/A	R
	(none)	STAT:MEAS:ENAB <num>	N/A	W
	(none)	STAT:QUES:EVEN?	N/A	R
	(none)	STAT:QUES:COND?	N/A	R
	(none)	STAT:QUES:ENAB?	N/A	R
	(none)	STAT:QUES:ENAB <num>	N/A	W

## 1523, 1524 Reference Thermometer

### Serial Commands - Alphabetic Listing

Functions or Groups	SCREEN PARAMETER	Command	Password Protection Group	Read/Write
System - Communication	BAUD RATE	SYST:COMM:SER:BAUD?	N/A	R
	BAUD RATE	SYST:COMM:SER:BAUD <baud>	N/A	W
	SERIAL PORT	SYST:COMM:SER:OFF	N/A	W
System - Information	(all)	*IDN?	N/A	R
	(none)	*CLS	N/A	W
	(none)	SYST:SNUM?	N/A	R
	(none)	SYST:VERS?	N/A	R
	(none)	SYST:ERR?	N/A	R
	DATE	SYST:DATE?	N/A	R
	DATE	SYST:DATE <year>,<month>,<day>	N/A	W
	TIME	SYST:TIME?	N/A	R
	TIME	SYST:TIME <hour>,<minute>,<second>	N/A	W
System - Password	(none)	SYST:PASS:CDIS	N/A	W
	PASSWORD	SYST:PASS:CEN	N/A	W
	(none)	SYST:PASS:CEN:STAT?	N/A	R
	USER PASSWORD	SYST:PASS:NEW	conditional	W
*indicates the command is password controlled. Reference "System - Password" section for password input.				

## 6.4 Serial Commands - Alphabetic Listing

Each command description provides the structure (long and short format), a description of the command purpose, a command example, an example of what the command returns (as applicable to query commands), and notes specific to the command. The following apply to each group of commands:

- Numeric data, specified by the mnemonic, <num>, uses ASCII characters to represent numbers. Numbers may contain a plus or minus ('+' or '-') sign, decimal point ('.'), and exponent ('E' or 'e') with its sign. If a fractional component is received when only an integer is required, the number is rounded to the nearest integer without any resulting error message. The mnemonics DEF, MIN, and MAX are often acceptable for the default, minimum, and maximum value respectively. Unit suffixes, such as V or OHM, can be appended to numeric parameters and are accepted without error but ignored.
- Unrecognized commands or commands with incorrect syntax or invalid parameters generate error messages in the error queue.
- Upper case letters designate syntax that is required when issuing the command. Lower case letters are optional and may be omitted.
- <> indicates a required parameter.
- [ ] indicates optional parameters.
- ( ) indicates a group of parameters that must be used together.



- For query commands, specifying the MIN, MAX, or DEF parameter causes the instrument to respond with the minimum, maximum, or default setting respectively.
- For set commands, specifying the MIN, MAX, or DEF parameters causes the instrument to use the minimum, maximum, or default setting respectively.
- ‘|’ indicates alternate parameter values.
- <n> indicates a number is required.
- <prb> indicates a probe number (1 or 2) is required.
- <num> indicates numeric value is required.
- <bool> indicates a Boolean value (0 or 1) is required. The mnemonics OFF and ON are also accepted for 0 and 1, respectively.
- <conv> indicates a conversion mnemonic is required.
- <param> indicates a parameter name is required.
- <seri> indicates a serial number is required.
- <unit> indicates a temperature unit is required.
- <temp> indicates a temperature °C/F is required.
- <pass> indicates a password is required.
- <port> indicates a port number is required.
- <label> indicates an eight character label is required.
- <year> indicates a four digit number is required.
- <month> indicates a one or two digit number is required.
- <day> indicates a one or two digit number is required.
- <hour> indicates a one or two digit number is required.
- <minute> indicates a one or two digit number is required.
- <second> indicates a one or two digit number is required.
- <baud> indicates a valid baud number is required.

**\*CLS**

Clear the event registers and the error queue.

Example: \*CLS

This command has no response.

**\*IDN?**

Returns the instrument identification string that indicates the manufacturer, model number, serial number, and firmware version.

Example: \*IDN?

Response: FLUKE,1524,23456,1.00

### **\*RST**

Set the instrument operating parameters to defined conditions.

Example: \*RST

This command has no response.

### **CALCulate:AVERage:CLEar**

Clear the statistical functions for all probes.

Example: CALC:AVER:CLE

### **CALCulate<prb>:AVERage<n>:DATA?**

Returns the value of a statistical calculation for a given probe. The CALCulate suffix, <prb>, specifies the probe, 1 or 2. Default to 1 if omitted. The AVERage suffix, <n>, specifies the calculation type number as listed in Table 19 on page 73. Defaults to 1 if omitted.

Example: CALC2:AVER1:DATA?

Response: 0.017

### **CALCulate:AVERage<n>:TYPE?**

Returns the keyword for the specified field type number. The AVERage suffix, <n>, specifies the calculation type number. Default to 1 if omitted.

Example: CLAC:AVER4:TYPE?

Response: STD

### **CALCulate<prb>:CONVert:DATE:CALibrate?**

Returns the last calibration date for the specified probe. The CALCulate suffix, <prb>, specifies the probe, 1 or 2. Defaults to 1 if omitted. The response is returned in the format <year>,<month>,<day>.

Example: CALC1:CONV:DATE:CAL?

Response: 2000,9,22

### **CALCulate<prb>:CONVert:DATE:CALibrate <year>,<month>,<day>**

Set the last calibration date for the specified probe.

The CALCulate suffix, <prb>, specifies the probe, 1 or 2. Defaults to 1 if omitted.

The <year> parameter is a four-digit number, 2000 to 2099.

The <month> parameter is a one or two-digit number, 1 to 12.

The <day> parameter is a one or two digit number, 1 to 31.

Example: CALC1:CONV:DATE:CAL 2000,8,29

**NOTE:** This command is protected, which requires a password to set it.

Error ‘-2003, “Command protected”’ is queued if the password has not been entered with SYST:PASS:CEN

### **CALCulate<prb>:CONVert:NAME?**

Return the keyword of the selected conversion type for the specified probe.

The CALCulate suffix, <prb>, specifies the probe, 1 or 2. Defaults to 1 if omitted.

Available conversion types are listed in Table 20 on page 73.

Example: CALC1:CONV:NAM?

Response: CVD

### **CALCulate<prb>:CONVert:NAM <conv>**

Set the conversion type for the specified probe.

The CALCulate suffix, <prb>, specifies the probe, 1 or 2. Defaults to 1 if omitted.

The <conv> parameter is the keyword for the conversion type as listed in Table 20 on page 73.

To activate the new probe conversion type and update the display, the command CALC:CONV:UPD must be sent, the probe must be removed and inserted, or the unit power must be cycled on and off.

Example: CALC2:CONV:NAM CVD

**NOTE:** This command is protected, which requires a password to set it.

Error ‘-2003, “Command protected”’ is queued if the password has not been entered with SYST:PASS:CEN

### **CALCulate<prb>:CONVert:PARAMeter:CATalog?**

Return the keywords of the probe characterization parameters associated with the current conversion type for the specified probe.

The CALCulate suffix, <prb>, specifies the probe, 1 or 2. Defaults to 1 if omitted.

Each item in the response list is enclosed in double-quotes and separated from other items by a comma. Each item indicates the keyword of a characterization parameter for the current conversion type. If there are no parameters available for the current conversion type, an empty string is returned.

The list of parameters depends on the selected conversion type as listed in Table 21 on page 74.

Example: CALC2:CONV:PAR:CAT?

Response: "R0", "A", "B", "C", "MINOP", "MAXOP"

**CALCulate<prb>:CONVert:PARAmeter:VALue? <param>**

Return the value of the specified conversion parameter for the specified probe.

The CALCulate suffix, <prb>, specifies the probe, 1 or 2. Defaults to 1 if omitted.

The <param> parameter is the keyword of the parameter as listed in Table 21 on page 74.

Example: CALC2:CONV:PAR:VAL? RTPW

Response: 100.0145

**CALCulate<prb>:CONVert:PARAmeter:VALue <param>,<num>**

Set the value of the specified conversion parameter for the specified probe.

The CALCulate suffix, <prb>, specifies the probe, 1 or 2. Defaults to 1 if omitted.

The <param> parameter is the keyword of the parameter as listed in Table 21 on page 74.

The <num> parameter is the new value with type and range per the list in Table 21 on page 74.

To activate the new values for the parameters MINOP and MAXOP and update the display, the command CALC:CONV:UPD must be sent, the probe must be removed and inserted, or the unit power must be cycled off and on.

Example: CALC2:CONV:PAR:VAL RTPW,100.0145

***NOTE:** This command is protected, which requires a password to set it.*

Error '-2003, "Command protected"' is queued if the password has not been entered with SYST:PASS:CEN

**CALCulate<prb>:CONVert:SNUMber?**

Return the probe serial number for the specified probe.

The CALCulate suffix, <prb>, specifies the probe, 1 or 2. Defaults to 1 if omitted.

Example: CALC2:CONV:SNUM?

Response: A\_336C

**CALCulate<prb>:CONVert:SNUMber <seri>**

Set the probe serial number for the specified probe.

The CALCulate suffix, <prb>, specifies the probe, 1 or 2. Defaults to 1 if omitted.

The <seri> parameter consists of up to ten characters, limited to upper case letters, numeric digits, and the underscore ‘\_’.

Example: CALC2:CONV:SNUM A-336C

**NOTE:** This command is protected, which requires a password to set it.

Error ‘-2003, “Command protected”’ is queued if the password has not been entered with SYST:PASS:CEN

**CALCulate<prb>:CONVert:TEST? <res>|<mv>[,rjt]**

Return the calculated temperature in Celsius for the giving sensor reading.

The CALCulate suffix, <prb>, specifies the probe, 1 or 2. Defaults to 1 if omitted.

The parameter <res> is the sensor reading in ohms for PRT or thermistor.

The parameter <mv> is the sensor reading in millivolts for thermocouples, with optional reference junction temperature <rjt> in Celsius, which defaults to 0 if omitted.

Example: CALC2:CONV:TEST? 100.0

Response: 0.0

**CALCulate<prb>:CONVert:UPDate**

Update the display with the latest configuration data from the probe(s).

All probe data is reread and the display(s) are updated accordingly.

Example: CALC2:CONV:UPD

**CALCulate<prb>:CONVert:IDENtity?**

Return the probe data structure identity number for the specified probe.

The CALCulate suffix, <prb>, specifies the probe, 1 or 2. Defaults to 1 if omitted.

Example: CALC2:CONV:IDEN?

Response: 23

**CALCulate<prb>:CONVert:IDENtity <num>**

Set the probe data structure identity number for the specified probe.

The CALCulate suffix, <prb>, specifies the probe, 1 or 2. Defaults to 1 if omitted.

The <num> parameter is an integer value, 0 to 255.

Example: CALC2:CONV:IDEN 23

**NOTE:** This command is protected, which requires a password to set it.

Error ‘-2003, “Command protected”’ is queued if the password has not been entered with SYST:PASS:CEN

### **CALCulate<prb>:CONVert:VERSion?**

Return the probe data structure version number for the specified probe.

The CALCulate suffix, <prb>, specifies the probe, 1 or 2. Defaults to 1 if omitted.

Example: CALC2:CONV:VERS?

Response: 1

### **CALCulate<prb>:CONVert:VERSion <num>**

Set the probe data structure version number for the specified probe.

The CALCulate suffix, <prb>, specifies the probe, 1 or 2. Defaults to 1 if omitted.

The <num> parameter is an integer value, 0 to 255.

Example: CALC2:CONV:VERS 1

*NOTE: This command is protected, which requires a password to set it.*

Error '-2003, "Command protected"' is queued if the password has not been entered with SYST:PASS:CEN

### **CALibrate:DEVice:AUTO?**

Return the state of the automatic power off feature.

The response is ON or OFF.

Example: CAL:DEV:AUTO?

Response: ON

### **CALibrate:DEVice:AUTO <val>**

Set the state of the automatic power off feature.

The <val> parameter is ON or OFF. When turned on, the timer is set to a default of 30 minutes.

Example: CAL:DEV:AUTO ON

### **CALibrate<chn>:DEVice:LOCK?**

Return the lock status of the channel and the inserted probe if any.

The CALibrate suffix, <chn>, specifies the channel, 1 or 2. Defaults to 1 if omitted.

If no probe is inserted, the response is 0 if the channel is not locked, otherwise 1.

If a probe is inserted, the response is 0 if both the channel and the probe are not locked; otherwise 1 if either is locked.

The CALibrate<chn>:DEVice:LOCK:DATA query may be used to obtain details of the channel and probe locks.

Example: CAL2:DEV:LOCK?

Response: 1

**CALibrate<chn>:DEVice:LOCK<bool>**

Exclusively locks the channel to the inserted probe, or unlocks either.

The CALibrate suffix, <chn>, specifies the channel, 1 or 2. Defaults to 1 if omitted.

The parameter <bool> is 1 to exclusively lock the channel to the inserted probe. No lock takes place and error '-200, "Execution error"' is queued if no probe is inserted, if the channel is already locked, or if the probe is already locked.

The parameter <bool> is 0 to unlock the channel, the inserted probe if any, or both. If no probe is inserted, only the channel is unlocked. If either is already unlocked, no action is taken for the unlocked item and no error is queued.

Example: CAL2:DEV:LOCK 1

*NOTE: This command is protected, which requires a password to set it.*

Error '-203, "Command protected"' is queued if the password has not been entered with SYST:PASS:CEN.

**CALibrate<chn>:DEVice:LOCK:DATA?**

Returns the lock details of the channel and the inserted probe if any.

The CALibrate suffix, <chn>, specifies the channel, 1 or 2. Defaults to 1 if omitted.

The first item returned is the probe serial number to which the channel is exclusively locked. If the channel is not locked, "" is returned.

The second item returned is the unit serial number to which the probe is exclusively locked. If the probe is not locked or no probe is inserted, "" is returned.

The third item returned is the unit channel to which the probe is exclusively locked. If the probe is not locked or no probe is inserted, 0 is returned.

Example: CAL2:DEV:LOCK:DATA?

Response: "ALPHA\_5","51789",2

**CALibrate:DEVice:RANGe:ADJust<num>?**

Return the calibration offset from the reference value for a calibration point of the preselected range.

The ADJust suffix, <num>, specifies the calibration point, 1 to the number set with the associated command CAL:DEV:RANG:NUM. If omitted, offset values for all points are returned, separated by commas.

The range must have been preselected with the command CAL<chn>:DEV:RANG:SEL.

## 1523, 1524 Reference Thermometer

### Serial Commands - Alphabetic Listing

---

The response is expressed in ohms or millivolts depending on the range being calibrated.

Example: CAL:DEV:RANG:ADJ2?

Response: .107

#### **CALibrate:DEVice:RANGe:ADJust<num> <val>**

Set the calibration offset from the reference value for a calibration point of the preselected range.

The ADJust suffix, <num>, specifies the calibration point, 1 to the number set with the associated command CAL:DEV:RANG:NUM. Defaults to 1 if omitted.

The range must have been preselected with the command CAL<chn>:DEV:RANG:SEL.

The parameter <val> is the offset value expressed in ohms or millivolts depending on the range being calibrated.

Example: CAL:DEV:RANG:ADJ2 -.065

***NOTE:** This command is protected, which requires a password to set it.*

Error '-203,"Command protected"' is queued if the password has not been entered with SYST:PASS:CEN.

#### **CALibrate<chn>:DEVice:RANGe:CLEar**

Reset all calibration points for the preselected range of the specified channel to defaults.

The CALibrate suffix, <chn>, specifies the channel, 1 or 2. Defaults to 1 if omitted.

The range must have been preselected with the command CAL<chn>:DEV:RANG:SEL.

All calibration points are set to a gain of one and an offset of zero.

Example: CAL:DEV:RANG:CLE

***NOTE:** This command is protected, which requires a password to set it.*

Error '-203,"Command protected"' is queued if the password has not been entered with SYST:PASS:CEN.

#### **CALibrate:DEVice:RANGe:NUMber?**

Return the number of calibration points for the preselected range.

The range must have been preselected with the command CAL<chn>:DEV:RANG:SEL.

The response is the number of calibration points in use.



Example: CAL:DEV:RANG:NUM?

Response: 2

**CALibrate:DEVice:RANGe:NUMBER <val>**

Set the number of calibration points to use for the preselected range.

The range must have been preselected with the command  
CAL<chn>:DEV:RANG:SEL.

The parameter <val> must be 2 to 4.

Example: CAL:DEV:RANG:NUM 2

*NOTE: This command is protected, which requires a password to set it.*

Error ‘-203,“Command protected”’ is queued if the password has not been entered with SYST:PASS:CEN.

**CALibrate:DEVice:RANGe:REFerence<num>?**

Return the reference value for a calibration point of the preselected range.

The REFerence suffix, <num>, specifies the calibration point, 1 to the number set with the associated command CAL:DEV:RANG:NUM. If omitted, reference values for all points are returned, separated by commas.

The range must have been preselected with the command  
CAL<chn>:DEV:RANG:SEL.

The response is expressed in ohms or millivolts depending on the range being calibrated.

Example: CAL:DEV:RANG:REF2?

Response: 10.568

**CALibrate:DEVice:RANGe:REFerence<num> <val>**

Set the reference value for a calibration point of the preselected range.

The REFerence suffix, <num>, specifies the calibration point, 1 to the number set with the associated command CAL:DEV:RANG:NUM. Defaults to 1 if omitted.

The range must have been preselected with the command  
CAL<chn>:DEV:RANG:SEL.

The parameter <val> is the reference value expressed in ohms or millivolts depending on the range being calibrated.

The reference points, 1 to the specified number, must be entered in ascending order.

Example: CAL:DEV:RANG:REF2 10.568

*NOTE: This command is protected, which requires a password to set it.*

Error ‘-203,”Command protected”’ is queued if the password has not been entered with SYST:PASS:CEN.

### **CALibrate<chn>:DEVice:RANGe:SELECTION?**

Return the range presently being calibrated for the specified channel.

The CALibrate suffix, <chn>, specifies the channel, 1 or 2. Defaults to 1 if omitted.

The response is one of the keywords listed in Table 22 on page 75.

Example: CAL:DEV:RANG:SEL?

Response: LO\_OHMS

### **CALibrate<chn>:DEVice:RANGe:SELECTION <val>**

Set the range presently being calibrated for the specified channel.

The CALibrate suffix, <chn>, specifies the channel, 1 or 2. Defaults to 1 if omitted.

The parameter <val> is one of the keywords in Table 22 on page 75. The value NORMAL exits calibration mode, reconnects the inserted probe if any, and refreshes the display.

This command sets the range to which all of the following commands apply:

CAL:DEV:RANG:CLEAR

CAL:DEV:RANG:NUM

CAL:DEV:RANG:REF

CAL:DEV:RANG:ADJ

Example: CAL:DEV:RANG:SEL LO\_OHMS

### **DISPlay<chn>:RESolution?**

Return the maximum display resolution setting for the channel.

The DISPlay suffix, <chn>, specifies the channel, 1 or 2. Defaults to 1 if omitted.

Example: DISP1:RES?

Response: 2

### **DISPlay<chn>:RESolution <num>**

Set the maximum display resolution for the channel.

The DISPlay suffix, <chn>, specifies the channel, 1 or 2. Defaults to 1 if omitted.

Example: DISP1:RES 3

**FEtCh? <prb>**

Return the last measurement for the specified probe, with units according to the UNIT:TEMP setting if it is a temperature.

The <prb> parameter specifies the probe, 1 or 2. Defaults to 1 if omitted.

If there is no valid measurement available, the response is "0.0, OL".

Example: FETC? 1

Response: 105.236

**LOGging:AUTomatic:DElete <num>**

Delete all entries from an auto tag number.

The parameter <num> is the tag number for which all entries are to be deleted, 1 to 25, or 0 to delete all entries for all tags.

Error '-221,"Settings conflict"' is queued if the data logging storage is corrupt, or if the automatic delete or send display is active.

Example: LOG:AUT:DEL 10

**LOGging:AUTomatic:FREE?**

Return the number of Auto-Log entries free, and in use by all tags.

The response consists of the number free entries, followed by the number of used entries, separated by a comma.

Error '-221,"Settings conflict"' is queued if the data logging storage is corrupt.

Example: LOG:AUT:FREE?

Response: 3760,1126

**LOGging:AUTomatic:LABel?**

Return the tag number to which the LOG:AUT:POIN, LOG:AUT:STAT, and LOG:AUT:VAL commands presently apply.

Return a value of 1 to 25, or 0 if not set.

Error '-221,"Settings conflict"' is queued if the data logging storage is corrupt.

## 1523, 1524 Reference Thermometer

### Serial Commands - Alphabetic Listing

---

Example: LOG:AUT:LAB?

Response: 15

#### **LOGging:AUTomatic:LABel <num>**

Set the tag number to which the LOG:AUT:POIN, LOG:AUT:STAT, and LOG:AUT:VAL commands presently apply.

The <num> parameter specifies tag number, 1 to 25.

Error '-221,"Settings conflict"' is queued if the data logging storage is corrupt.

Example: LOG:AUT:LAB 4

#### **LOGging:AUTomatic:POINt?**

Return the number of Auto-Log entries already stored for a preselected tag number.

The tag number addressed must have been previously selected with the LOG:AUT:LAB command.

Error '-221,"Settings conflict"' is queued if the data logging storage is corrupt, or if no tag is selected with LOG:AUT:LAB.

Example: LOG:AUT:POIN?

Response: 28

#### **LOGging:AUTomatic:PRINt <num>**

Send all Auto-Log entries for a tag number.

The <num> parameter specifies tag number, 1 to 25.

Each data line includes the default or user defined tag name, the channel number, the primary value and units, and the time and date. When both channels are active, records for each channel alternate. When only one channel is active, no records are sent for the inactive channel.

Error '-221,"Settings conflict"' is queued if the data logging storage is corrupt.

Example: LOG:AUT:PRIN 5

Response:

```
DATA_25,1,22.676,C,15:19:42.0,2000-05-24
DATA_25,2,9.960,KO,15:19:44.0,2000-05-24
DATA_25,1,23.220,C,15:19:46.0,2000-05-24
DATA_25,2,23.245,C,15:19:48.0,2000-05-24
DATA_25,1,22.765,C,15:19:50.0,2000-05-24
DATA_25,2,9.962,KO,15:19:52.0,2000-05-24
DATA_25,1,23.087,C,15:19:54.0,2000-05-24
DATA_25,2,23.260,C,15:19:56.0,2000-05-24
```

### **LOGging:AUTomatic:STATus?**

Return the Auto-Log status for a preselected tag number

Returns a 0 if an Auto-Log session is not running, or a 1 if an Auto-Log session is running.

The tag number addressed must have been previously selected with the LOG:AUT:LAB command.

Error '-221,"Settings conflict"' is queued if the data logging storage is corrupt, or if no tag is selected with LOG:AUT:LAB.

Example: LOG:AUT:STAT?

Response: 0

### **LOGging:AUTomatic:STATus <bool>**

Set the Auto-Log status for a preselected tag number

The <bool> parameter turns auto logging on if set to 1, or off if set to 0. If another tag is presently being logged, it is automatically stopped.

The tag number addressed must have been previously selected with the LOG:AUT:LAB command.

Error '-221,"Settings conflict"' is queued if the data logging storage is corrupt, if no tag is selected with LOG:AUT:LAB, or if the LOG or any recall menu display is active.

Example: LOG:AUT:STAT 0

### **LOGging:AUTomatic:TIME?**

Return the Auto-Log interval.

Returns AUTO, 1, 2, 5, 10, 30, or 60. Numeric intervals are expressed in seconds.

Error ‘-221,”Settings conflict”’ is queued if the data logging storage is corrupt.

Example: LOG:AUT:TIM?

Response: 1

### **LOGging:AUTomatic:TIME <rate>**

Set the Auto-Log interval.

The <rate> parameter must be one of the following values: AUTO, 1, 2, 5, 10, 30, or 60. Numeric intervals are expressed in seconds. AUTO logs unique values as often as they are available.

Error ‘-221,”Settings conflict”’ is queued if the data logging storage is corrupt, if the LOG menu is active, or if data logging is active.

Example: LOG:AUT:TIM 1

### **LOGging:AUTomatic:VALue? <num>**

Return the specified Auto-Log entry for a preselected tag number.

The <num> parameter specifies the Auto-Log entry to return. Specifying 0 returns the first (oldest) log entry. Specifying a value greater than the number of logged points returns the last log entry.

Each data line includes the default or user defined tag name, the channel number, the primary value and units, and the time and date. When both channels are active, records for each channel alternate. When only one channel is active, no records are sent for the inactive channel.

The tag number addressed must have been previously selected with the LOG:AUT:LAB command.

Error ‘-221,”Settings conflict”’ is queued if the data logging storage is corrupt, or if no tag is selected with LOG:AUT:LAB.

Example: LOG:AUT:VAL? 10

Response:

DATA\_25,1,23.220,C,15:19:46.7,2000-05-24

DATA\_25,2,23.220,C,15:19:46.7,2000-05-24

### **LOGging:DEMAND:DELeTe**

Delete all entries from the demand log.

Error ‘-221,”Settings conflict”’ is queued if the data logging storage is corrupt, or if the demand recall or demand delete display is active.

Example: LOG:DEM:DEL

**LOGging:DEMAND:FREE?**

Return the number of demand log entries free, and in use

The response consists of the number free entries, followed by the number of used entries, separated by a comma.

Error '-221,"Settings conflict"' is queued if the data logging storage is corrupt.

Example: LOG:DEM:FREE?

Response: 8,17

**LOGging:DEMAND:POINT?**

Return the number of demand log entries already stored.

Error '-221,"Settings conflict"' is queued if the data logging storage is corrupt.

Example: LOG:DEM:POIN?

Response: 17

**LOGging:DEMAND:PRINT**

Send all demand log entries.

This example shows the 1524 return data. A single channel, and no time and date, are shown on the 1523 return data.

Each data line includes the default or user defined demand log description, the channel number, the primary value and units, and on the 1524 the time and date. When both channels are active, records for each channel alternate. When only one channel is active, no records are sent for the inactive channel.

Error '-221,"Settings conflict"' is queued if the data logging storage is corrupt.

## 1523, 1524 Reference Thermometer

Serial Commands - Alphabetic Listing

---

Example: LOG:DEM:PRIN

Response:

DTEST,1,22.676,C,15:19:42,2000-05-24

DTEST,2,9.960,KO,15:19:44,2000-05-24

DTEST,1,23.220,C,15:19:46,2000-05-24

DTEST,2,23.245,C,15:19:48,2000-05-24

DTEST,1,22.765,C,15:19:52,2000-05-24

DTEST,2,9.962,KO,15:19:54,2000-05-24

DTEST,1,23.087,C,15:19:56,2000-05-24

DTEST,2,23.260,C,15:19:58,2000-05-24

### **LOGging:DEMAND:VALue? <num>**

Return the specified demand log entry.

The <num> parameter specifies the demand log entry to return, 1 to 25. Specifying 0 returns the first (oldest) log entry. Specifying a value greater than the number of logged points returns the last log entry.

The example shows the 1524 return data. A single channel, and no time and date, are shown on the 1523 return data.

Each data line includes the default or user defined demand log description, the channel number, the primary value and units, and on the 1524 the time and date. When both channels are active, records for each channel alternate. When only one channel is active, no records are sent for the inactive channel.

Error '-221,"Settings conflict"' is queued if the data logging storage is corrupt.

Example: LOG:DEM:VAL? 10

Response:

DTEST,1,125.820,C,15:19:46,2000-05-24

DTEST,2,23.220,C,15:19:46,2000-05-24

### **LOGging:DEMAND:STATistic<n>? <num>**

Return the specified demand log statistical or auxiliary value for the specified demand log entry.

The STATistic suffix, <n>, specifies the demand log statistical type number as listed in Table 23 on page 76. Defaults to 1 if omitted.

The <num> parameter specifies the demand log entry to return, 1 to 25. Specifying 0 returns the first (oldest) log entry. Specifying a value greater than the number of logged points returns the last log entry.



The example shows the 1524 return data. A single channel, and no time and date, are shown on the 1523 return data.

Each data line includes the default or user defined demand log description, the channel number, the requested value and units, and on the 1524 the time and date. When both channels are active, records for each channel alternate. When only one channel is active, no records are sent for the inactive channel.

Error '-221,"Settings conflict"' is queued if the data logging storage is corrupt.

Example: LOG:DEM:STAT2? 10

Response:

DTEST,1,803.220,C,15:19:46,2000-05-24

DTEST,2,-157.158,C,15:19:46,2000-05-24

### **LOGging:LABel<n>:NAME?**

Return the user defined tag name of the specified auto logging tag number, or the demand log user defined name.

If the LABEL suffix, <n>, is supplied, it specifies the auto logging tag number of the user defined tag name to return, 1 to 25. If no user defined name has been entered for the tag number, the default tag name DATA\_nn is returned.

If no suffix is supplied, the demand log user defined name is returned. If no user defined name has been entered for the demand log, the default name DEMAND is returned.

Error '-221,"Settings conflict"' is queued if the data logging storage is corrupt.

Example: LOG:LAB18:NAME?

Response: DATA\_18

### **LOGging:LABel<n>:NAME <label>**

Set the user defined tag name of the specified auto logging tag number, or the demand log user defined name.

If the LABEL suffix, <n>, is supplied, it specifies the auto logging tag number of the new name, 1 to 25.

If no suffix is supplied, the new name is saved for the demand log.

The <name> parameter can be up to 8 characters in length and can include any upper case letters, numeric digits, and the underscore ('\_').

Error '-221,"Settings conflict"' is queued if the data logging storage is corrupt.

Example: LOG:LAB18:NAME BATH

### **MEASure? <prb>**

Return the last measurement for the specified probe, with units according to the UNIT:TEMP setting if it is a temperature.

The <prb> parameter specifies the probe, 1 or 2. Defaults to 1 if omitted.

If there is no valid measurement available the response is "0.0,OL".

Example: MEAS? 1

Response: 0.127

### **READ? <prb>**

Return the last measurement for the specified probe, with units according to the UNIT:TEMP setting if it is a temperature.

The <prb> parameter specifies the probe, 1 or 2. Defaults to 1 if omitted.

If there is no valid measurement available the response is "0.0,OL".

Example: READ? 2

Response: 55.011

### **SENSe<prb>:DATA:MV?**

Return the present direct or thermocouple millivolt reading for the specified probe.

The SENSe suffix, <prb>, specifies the probe, 1 or 2. Defaults to 1 if omitted.

The response is expressed in millivolts. If there is no valid measurement available the response is "0.0,OL".

If the presently selected input type is not millivolts or thermocouple, there will be no response and error '-221,"Settings conflict"' will be queued.

Example: SENS2:DATA:MV?

Response: 7.356895

### **SENSe<prb>:DATA:OHMS?**

Return the present direct, PRT, RJ, or thermistor ohms reading for the specified probe.

The SENSe suffix, <prb>, specifies the probe, 1 or 2. Defaults to 1 if omitted.

The response is expressed in ohms. For a thermocouple probe, the response is the reference junction ohms value. If there is no valid measurement available the response is "0.0,OL".

If the presently selected input type is millivolts, there will be no response and error '-221,"Settings conflict"' will be queued.

Example: SENS2:DATA:OHMS?

Response: 100.45

**SENSe:DATA:RJ?**

Return the present internal or external reference junction temperature reading for the specified probe.

The response is expressed in degrees Celsius.

If the presently selected input type is not millivolts or thermocouple, there will be no response and error '-221,"Settings conflict"' will be queued.

Example: SENS:DATA:RJ?

Response: 23.568

**SENSe:RJ:STATe?**

Return the state of the reference junction for a given probe.

The response is OFF (no compensation), ON (automatic internal compensation), or EXT (external compensation). If EXT is selected, the SENS:RJ:TEMP command must be used to set the external compensation temperature.

Example: SENS:RJ:STAT?

Response: EXT

**SENSe:RJ:TEMPerature?**

Return the external reference junction temperature for a given probe.

The response is expressed in degrees Celsius.

Example: SENS:RJ:TEMP?

Response: 22.731

**SENSe:RJ:TEMP <val>**

Set the external reference junction temperature for a given probe.

The parameter <val> is expressed in degrees Celsius, and may range from -10C to 60C.

Example: SENS:RJ:TEMP 23.123

**STATus:MEASure:EVENT?**

Read and clear the Measurement Event Register, indicating whether or not a new measurement is available to be read.

The bit assignments are as follows:

bit 0: probe 1 new measurement  
bits 1 to 7: not used  
bit 8: probe 2 new measurement  
bits 9 to 15: not used

Example: STAT:MEAS?

Response: 257

### **STATus:MEASure:CONDition?**

Return the Measurement Condition Register, indicating whether or not measuring is active.

The bit assignments are the same as for STATus:MEASure?

Example: STAT:MEAS:COND?

Response: 257

### **STATus:MEASure:ENABle?**

Return the Measurement Event Enable Register.

The bit assignments are the same as for STATus:MEASure?.

Example: STAT:MEAS:ENAB?

Response: 0

### **STATus:MEASure:ENABle <num>**

Set the Measurement Event Enable Register.

The <num> parameter specifies the event enable bits which are to be set, 0 to 65535 decimal. The bit assignments are the same as for STATus:MEASure?

Example: STAT:MEAS:ENAB 257

### **STATus:QUESTionable:EVENT?**

Read and clear the Questionable Event Register, indicating any measurement warnings.

The bit assignments are as follows:

bit 0: probe 1 not inserted  
bit 1: probe 1 measurement under range  
bit 2: probe 1 measurement over range  
bit 3: probe 1 EEPROM fault (bad checksum or version number is not supported)

bit 4: probe 1 locked  
bits 5 to 7: not used  
bit 8: probe 2 not inserted  
bit 9: probe 2 measurement under range  
bit 10: probe 2 measurement over range  
bit 11: probe 2 EEPROM fault (bad checksum or  
version number is not supported)  
bit 12: probe 2 locked  
bits 13 to 14: not used  
bit 15: Data logging EEPROM initialization failure

Example: STAT:QUES?

Response: 256

### **STATus:QUESTionable:CONDition?**

Return the Questionable Condition Register, indicating any measurement warning conditions.

The bit assignments are the same as for the STATus:QUESTionable?.

Example: STAT:QUES:COND?

Response: 256

### **STATus:QUESTionable:ENABle?**

Return the Questionable Event Enable Register.

The bit assignments are the same as for STATus:QUESTionable?.

Example: STAT:QUES:ENAB?

Response: 0

### **STATus:QUESTionable:ENABle <num>**

Set the Questionable Event Enable Register.

The <num> parameter specifies the event enable bits which are to be set, 0 to 65535 decimal. The bit assignments are the same as for the STATus:QUESTionable?.

Example: STAT:QUES:ENAB 1799

### **SYSTem:COMMunicate:SERial:BAUD?**

Return the present serial port baud rate setting.

The response is the present baud rate setting.

Example: SYST:COMM:SER:BAUD?

Response: 9600

**SYSTem:COMMunicate:SERial:BAUD <baud>**

Set the serial port baud rate.

The <baud> parameter is the new baud rate, 2400 or 9600.

After this command is sent, the remote program must switch to the same baud rate for all commands sent to the unit.

Example: SYST:COMM:SER:BAUD 2400

**SYSTem:COMMunicate:SERial:OFF**

Turn off the serial port.

After this command is sent, the unit will not respond to any further commands. The port control item on the Instrument Setup screen of the unit must be used to turn the serial port back on.

Example: SYST:COMM:SER:OFF

**SYSTem:DATE?**

Return the date.

The response is returned in the format <year>,<month>,<day>.

This command is only available in the model 1524, and results in a command error if used with the model 1523.

Example: SYST:DATE?

Response: 2000,9,22

**SYSTem:DATE <year>,<month>,<day>**

Set the date.

The <year> parameter is a four-digit number, 2000 to 2099.

The <month> parameter is a one or two-digit number, 1 to 12.

The <day> parameter is a one or two-digit number. 1 to 31.

This command is only available in the model 1524, and results in a command error if used with the model 1523.

Example: SYST:DATE 2000,8,29

**SYSTem:ERRor?**

Return a system error message if any are present in the system error queue, otherwise it returns 0, "No error".

The error queue may contain up to ten messages. The messages are reported in the order in which they occurred. Reading a message from the queue removes the message so that the next message can be read. If more than ten errors occur before being read, the most recent is replaced by -350, "Queue overflow". Possible error messages are listed in Table 24 on page 76.

Example: SYST:ERR?

Response: 0, "No error"

**SYSTem:PASSword:CDISable**

Disable access to password protected commands.

Example: SYST:PASS:CDIS

This command has no response.

**SYSTem:PASSword:CENable <pass>**

Enable access to password protected commands.

The <pass> parameter is the present password.

Example: SYST:PASS:CEN 1234

This command has no response.

**SYSTem:PASSword:CENable:STATe?**

Return present state of password protection.

The response is 0 if password protection is disabled, or 1 if it is enabled.

Example: SYST:PASS:CEN:STAT?

Response: 0

**SYSTem:PASSword:NEW <pass>**

Set new password.

The <pass> parameter is the new password. It can be up to 10 characters in length and can include any upper case letters, numeric digits, and the underscore ('\_').

The default password at time of shipping is 1234.

## 1523, 1524 Reference Thermometer

### Serial Commands - Alphabetic Listing

---

Example: SYST:PASS:NEW 4321

This command has no response.

**NOTE:** This command is protected, which requires a password to set it.

Error ‘-203,”Command protected”’ is queued if the old password has not been entered with SYST:PASS:CEN.

#### **SYSTem:SNUMber?**

Return the device serial number.

If the serial number has not been set at the factory, a 0 is returned.

Example: SYST:SNUM?

Response: 509002

#### **SYSTem:TIME?**

Return the current system time in 24 hour format.

The response is returned in the 24 hour format, <hour>,<minute>,<second>.

This command is only available in the model 1524, and results in a command error if used with the model1523.

Example: SYST:TIME?

Response: 18,43,23

#### **SYSTem:TIME <hour>,<minute>,<second>**

Set the current system time.

The <hour>, <minute>, and <second> parameters must all be supplied.

The <hour> parameter is a one or two-digit number, 0 to 23.

The <minute> parameter is a one or two-digit number, 0 to 59.

The <second> parameter is a one or two-digit number 0 to 59.

This command is only available in the model 1524, and results in a command error if used with the model1523.

Example: SYST:TIME 18,43,23

#### **SYSTem:VERSion?**

Return the SCPI version number.



Example: SYST:VERS?

Response: 1999.0

**UNIT:TEMPerature?**

Return the temperature unit.

The response is either C for Celsius or F for Fahrenheit.

Example: UNIT:TEMP?

Response: C

**UNIT:TEMPerature <unit>**

Set the temperature unit.

The <unit> parameter is either C for Celsius or F for Fahrenheit.

Example: UNIT:TEMP C

**Table 19** *Statistical Types*

Number	Type	Keyword
1	Maximum	MAX
2	Minimum	MIN
3	Average	AVE
4	Standard Deviation	STD
5	Delta X	DX
6	Delta T	DT

**Table 20** *Probe Conversion Types*

Probe	Conversion	Keyword
<b>PRT</b>	ITS90	ITS
	ITS90-5	ITS5
	CVD	CVD
	PT100	RPRT
	Resistance	TRES
<b>Thermistor</b>	Polynomial R(T)	TRES
	Resistance	RTHM

## 1523, 1524 Reference Thermometer

Serial Commands - Alphabetic Listing

Probe	Conversion	Keyword
Thermocouple	Millivolts	V
	B	B
	C	C
	E	E
	J	J
	K	K
	L	L
	M	M
	N	N
	R	R
	S	S
	T	T
U	U	

**Table 21** Probe Characterization Parameters

Conversion	Keyword	Value
ITS90	RTPW	Double Floating Point
	A	Double Floating Point
	B	Double Floating Point
	C	Double Floating Point
	D	Double Floating Point
	A4	Double Floating Point
	B4	Double Floating Point
	MINOP	Integer, °C
	MAXOP	Integer, °C
ITS90-5	RTPW	Double Floating Point
	A	Double Floating Point
	B	Double Floating Point
	C	Double Floating Point
	A	Double Floating Point
	B5	Double Floating Point
	MINOP	Integer, °C
	MAXOP	Integer, °C
CVD	R0	Double Floating Point
	A	Double Floating Point
	B	Double Floating Point
	C	Double Floating Point
	MINOP	Integer, °C
	MAXOP	Integer, °C

Conversion	Keyword	Value
<b>PT100</b>	R0	Double Floating Point
	MINOP	Integer, °C
	MAXOP	Integer, °C
<b>Resistance</b>	MINOP	Integer, Ω
	MAXOP	Integer, Ω
<b>Polynomial R(T)</b>	B0	Double Floating Point
	B1	Double Floating Point
	B2	Double Floating Point
	B3	Double Floating Point
	MINOP	Integer, °C
	MAXOP	Integer, °C
<b>Thermocouple, mV</b>	MINOP	Integer, mV
	mV	MAXOP
<b>Thermocouple, other</b>	C0	Double Floating Point
	other	C1
	C2	Double Floating Point
	C3	Double Floating Point
	B0	Double Floating Point, internal RJ only
	B1	Double Floating Point, internal RJ only
	B2	Double Floating Point, internal RJ only
	B3	Double Floating Point, internal RJ only
	RJTYPE	0 external, 1 internal
	RJTEMP	Double Floating Point, External temperature, °C
	MINOP	Integer, °C
	MAXOP	Integer, °C

**Table 22** Calibration Range Identifiers

Range	Keyword
Normal operation	NORMAL
Millivolts calibration	MV
Reference junction calibration	RJ_OHMS
Very Low Ohms calibration	L75_OHMS
Low Ohms calibration	LO_OHMS
Medium Ohms calibration	MED_OHMS
High Ohms calibration	HI_OHMS

## 1523, 1524 Reference Thermometer

### Serial Commands - Alphabetic Listing

---

**Table 23** Demand Log Statistical Types

Number	Type
1	Maximum
2	Minimum
3	Average
4	Standard Deviation
5	Auxiliary Value

For all query commands, when an error is detected and an error message is placed in the queue, no response is returned for the query.

For all action commands, when an error is detected and an error message is placed in the queue, no action is taken.

If a thermocouple is inserted into channel 2, all commands except the SYST:ERR query command place the error '-221, "Settings conflict"' in the queue. This action complements the full lockout of all the keypad keys in this same circumstance.

Error messages are retrieved from the queue using the SYST:ERR query.

**Table 24** Error Messages

Number	Message
0	"No error"
-100	"Command error"
-200	"Execution error"
-203	"Command protected"
-221	"Settings conflict"
-350	"Queue overflow"
-360	"Communication error"
-363	"Input buffer overrun"

## **7 Calibration of Your Reference Thermometer Readout**

### **7.1 General**

*NOTE: For assistance with the process or any questions regarding the calibration of the Reference Thermometer, contact an Authorized Service Center. (See Section 1.8, Authorized Service Centers on page 5.)*

This procedure is to be considered a general guideline. Each laboratory should write their own procedure based on their equipment and their quality program. Each procedure should be accompanied by an uncertainty analysis also based on the laboratory's equipment and environment.

The 1523/24 Reference Thermometers are calibrated with a traceable calibration at the factory. This calibration is supported by good practices including an extensive uncertainty budget.

### **7.2 Introduction**

The reference resistors and voltage source must have low enough uncertainties to fit within your uncertainty budget. These uncertainties consist of a number of items including temperature coefficients and long term drift. There are other uncertainties to consider as well.

### **7.3 Terminology**

*NOTE: The Unit Under Test is referred to as the (UUT).*

### **7.4 Fundamentals**

It is assumed that the user is familiar with the 1523/24 Reference Thermometer User's Guide and Technical Guide.

The user shall be familiar with 4 wire and 2 wire resistance connections.

The user shall be familiar with the voltage source.

### **7.5 Environmental Test Conditions**

Temperature range:  $23^{\circ}\text{C} \pm 4^{\circ}\text{C}$

Ambient relative humidity: below 60%

### **7.6 Calibration Equipment**

The tables below describe the equipment needed to perform a 1523/24 reference thermometer calibration. The specifications for the reference resistors and voltage source are minimum requirements to meet a test uncertainty ratio (TUR) of 4 to 1.

# 1523, 1524 Reference Thermometer

## Manual Calibration

**Table 25** Test Equipment Specifications

Classification	Minimum Use	Recommended Equipment
Voltage Source	$\pm 6\text{ppm} \pm 0.6\mu\text{V}$	Fluke 5700
4 wire Reference Resistors	See Total Uncertainty column Table X	Vishay VHP100 Resistors
4 wire cable	Low resistance, Low EMF	N/A
Lemo Connector	6 pin	LEMO PAG.M0.6GL.AC39G

**Table 26** Standard Reference Resistor Specification

Resistance	Us1 (k=2)		Us2 (k=2)		Ut (k=2)	
	Reference Resistor Uncertainty (ppm)	Reference Resistor Uncertainty ( $\Omega$ )	TCR Uncertainty (ppm)	TCR Uncertainty ( $\Omega$ )	Total Uncertainty ( $\Omega$ )	Total Uncertainty (ppm)
0	--	0.00004	--	--	0.000540	--
25	28	0.0007	0.3	0.0000075	0.000700	28.0016
75	15.73	0.00117975	0.3	0.0000225	0.001180	15.7329
100	14	0.0014	0.3	0.00003	0.001400	14.0032
200	11.5	0.0023	0.3	0.00006	0.002301	11.5039
400	10.25	0.0041	0.3	0.00012	0.0041	10.2544
10000	35	0.35	0.3	0.003	0.3500	35.0013
40000	26.25	1.05	0.3	0.012	1.0501	26.2517
100000	74	7	0.3	0.03	7.0001	70.0006
300000	70	21	0.3	0.09	21.0002	70.0006
500000	70	35	0.3	0.15	35.0003	70.0006

**Table 27** Standard Voltage Reference Specification

Voltage mV	Reference Voltage Total Uncertainty (mV)
-10	0.00125
0	0.00110
25	0.00145
75	0.00210

## 7.7 Manual Calibration

### 7.7.1 General

This procedure outlines a manual process that closely follows the way the Reference Thermometer was calibrated at the factory. The user should adjust their calibration process to meet the needs of their facility and process. The following flow charts summarizes the process.

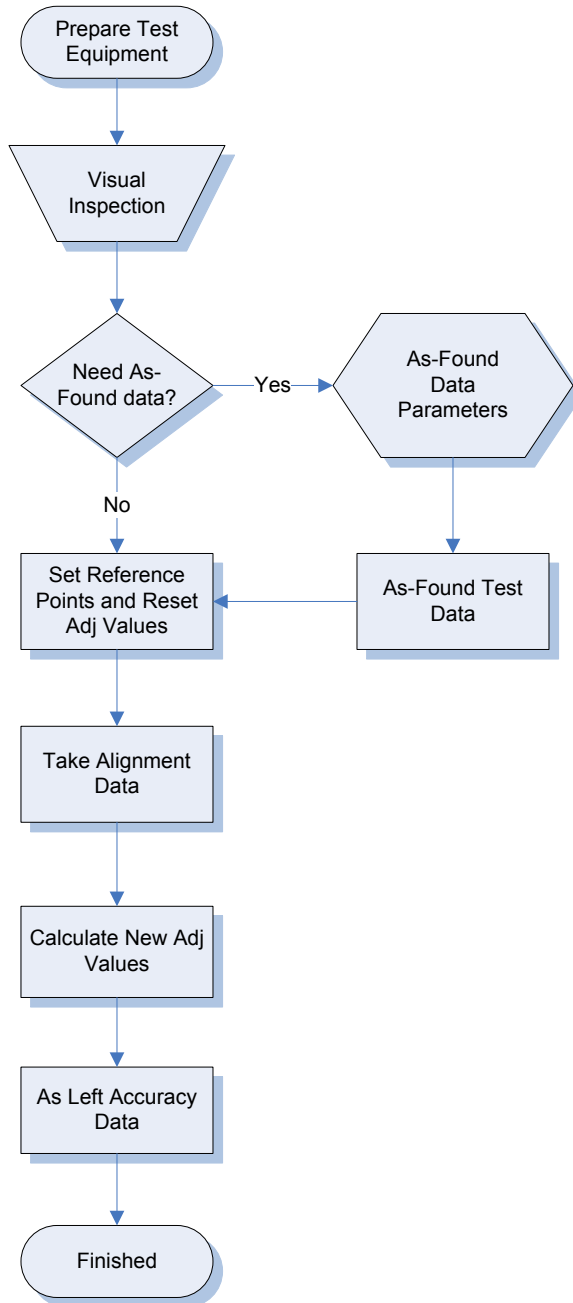

Figure 18 Flow chart for manual calibration

### 7.7.2 As Found Data Procedure

As Found data is used to determine if the readings and measurements taken since the last calibration are within specification. The data is also used to determine the amount of “drift” (how much the accuracies have changed over time) that the instrument has undergone.

#### 7.7.2.1 As Found Calibration Parameters

Recording the as found calibration parameters allows the user to compare the current parameters to the parameters set during the last calibration.

#### 7.7.2.2 As Found Data

The data taken at this step allows the user to compare the results to the previous calibration.

### 7.7.3 Alignment Procedure

The alignment procedure aligns each of the reference thermometer’s ranges to a set of known reference voltage and resistance standards. Reference points and their adjustment values are reset.

#### 7.7.3.1 Alignment Test Data

Once the reference points have been set and their adjustment points reset to zero, data at each calibration point is taken for each of the voltage and resistance ranges.

#### 7.7.3.2 Calculate New Adjustment Values

The alignment test data is used to calculate new Adjust (ADJ) values for each range based on the errors of certain cal points.

### 7.7.4 As Left Data

Data at each calibration point is taken for each of the voltage and resistance ranges and compared to the accuracy specifications. The standard deviation of the readings is calculated to ensure that it meets the specification.

## 7.8 Preparation for Reference Thermometer Calibration

### 7.8.1 Serial Communication

Enable the serial port of the UUT by pressing the SETUP key. Press NEXT to highlight Select Instrument then press ENTER. Press NEXT until the parameter Serial Port is shown. Toggle the up / down keys to select On and press ENTER. Press SETUP or HOME to return to the main screen.



### 7.8.2 Cabling

Use short (<1 meter) four-wire cabling from the UUT to the resistance and voltage references. The cabling should be connected to a Lemo Connector that does not contain a probe memory IC.

The 4-wire resistance connection uses pins 1 and 2 for one side of the reference resistor and pins 3 and 4 for the other side.

For the voltage calibration, connect only pins 2 and 3 to the voltage source. Pin 3 is the positive terminal and pin 2 is the negative terminal.

The thermocouple reference junction resistance test uses pins 1 and 4 to connect to the 10K reference resistor. This is a two wire connection for this test; DO NOT connect any other pins.

### 7.8.3 Scan Mode

The UUT must have the Fast Scan Mode and the Auto-Off mode turned off. Refer to the Instrument Settings menu.

### 7.8.4 AC Adapter

The UUT can be calibrated with or without the AC adapter. If using batteries, ensure they are new before starting the calibration procedure.

## 7.9 Manual Calibration Process

**NOTE:** 1. The 1523/24 is tested and calibrated using the tests outlined below in the order indicated. Details on performing each of the tests can be found in the subsequent section of this document.

2. For test specifications, durations, soak times, and other detailed information, refer to the specification tables below.

**Table 28** 1523/24 Accuracy Test Settings and Specifications

Resistance Range	Reference (Nominal) ( $\Omega$ )	Soak (Sec)	Samples	Spec ( $\pm\Omega$ )	Std Dev Spec ( $\pm\Omega$ )
L75_OHMS	0	20	40	0.002	0.0005
	25	20	40	0.003	0.00075
	75	20	40	0.005	0.00125
LO_OHMS	75	20	40	0.005	0.00125
	100	20	40	0.006	0.0015
	200	20	40	0.01	0.0025
	400	20	40	0.018	0.0045
MED_OHMS	200	20	40	0.52	0.13
	400	20	40	0.54	0.135
	10k	20	40	1.5	0.375
	40k	20	40	4.5	1.125

## 1523, 1524 Reference Thermometer

### Manual Calibration Process

Resistance Range	Reference (Nominal) ( $\Omega$ )	Soak (Sec)	Samples	Spec ( $\pm\Omega$ )	Std Dev Spec ( $\pm\Omega$ )
HI_OHMS	40k	20	40	12.0	3.0
	100k	20	40	30.0	7.5
	300k	20	40	90.0	22.5
	500k	20	40	150.0	37.5
RJ_OHMS	10k	20	40	5.0	1.25

**Table 29** 1523/24 Accuracy Test Settings and Specifications – Voltage

Reference (Nominal) (mV)	Soak (Sec)	Samples	Spec ( $\pm$ mV)	StdDev Spec ( $\pm$ mV)
-10	20	40	0.0055	0.00138
0	20	40	0.005	0.00125
25	20	40	0.0063	0.00156
75	20	40	0.0088	0.00219

## 7.9.1 Procedure

### 7.9.1.1 Visual Inspection

Perform a visual inspection of the UUT for signs of physical damage. If a problem is found, correct it before proceeding with the test., Contact an Authorized Service Center for repair or recalibration before proceeding.

### 7.9.1.2 1523/24 Calibration Parameters (As Found)

**NOTE:** If not taking As Found data, skip to the 1523/24 alignment section.

When the calibration process must collect As Found data, the following UUT configuration and control settings must remain at their current values until all As Found data has been collected. See table below.

**Table 30** As Found Readout/Calibration Parameter Settings

Parameter	Description
# of Cal Ref Points	Each Cal Range has 1 to 4 Ref Cal Points
Cal Ref Points	Reference values set to each cal point
Cal Adj values	Offsets used at each Cal Ref point

- Using a terminal program set the terminal program communication settings to:

Baud 9600  
 Parity None  
 Flow Control None  
 Stop Bits 1

2. Set the UUT password enable by sending the following commands through the serial port:  
SYST:PASS:CEN XXXX (XXXX is the current UUT password)  
Query the password enable to ensure communication is working and that it is enabled before continuing. Do this by sending the following command:  
SYST:PASS:CEN?  
The returned value should be a 1. If not recheck the serial cable connection and the terminal program communication settings listed in step 1.
3. Set the UUT to the L75\_OHMS cal range by sending the following commands through the serial port:  
CAL1:DEV:RANG:SEL L75\_OHMS
4. Query the Ref points by sending the following Command:  
CAL1:DEV:RANG:REF?
5. Query the ADJ values for the range by sending the following Command:  
CAL1:DEV:RANG:ADJ?  
The ADJ values will be in order of the ref points queried in the previous step.
6. Set the UUT in the LO\_OHMS cal range by sending the following commands through the serial port:  
CAL1:DEV:RANG:SEL LO\_OHMS
7. Query the Ref points by sending the following Command:  
CAL1:DEV:RANG:REF?
8. Query the ADJ values for the range by sending the following Command:  
CAL1:DEV:RANG:ADJ?  
The ADJ values will be in order of the ref points queried in the previous step.
9. Set the UUT in the MED\_OHMS cal range by sending the following commands through the serial port:  
CAL1:DEV:RANG:SEL MED\_OHMS
10. Query the Ref points by sending the following Command:  
CAL1:DEV:RANG:REF?
11. Query the ADJ values for the range by sending the following Command:  
CAL1:DEV:RANG:ADJ?  
The ADJ values will be in order of the ref points queried in the previous step.
12. Set the UUT in the HI\_OHMS cal range by sending the following commands through the serial port:  
CAL1:DEV:RANG:SEL HI\_OHMS
13. Query the Ref points by sending the following Command:  
CAL1:DEV:RANG:REF?
14. Query the ADJ values for the range by sending the following Command:  
CAL1:DEV:RANG:ADJ?

The ADJ values will be in order of the ref points queried in the previous step.

15. Set the UUT in the MV\_OHMS cal range by sending the following commands through the serial port:

```
CAL1:DEV:RANG:SEL MV_OHMS
```

16. Query the Ref points by sending the following Command:

```
CAL1:DEV:RANG:REF?
```

17. Query the ADJ values for the range by sending the following Command:

```
CAL1:DEV:RANG:ADJ?
```

The ADJ values will be in order of the ref points queried in the previous step.

18. Record the as found alignment parameters.

### 7.9.1.3 1523/24 Accuracy Test (As Found)

19. Connect the calibration cable, described in the Preparation and Settings for Reference readout Calibration section, to Channel T1 of the UUT. Using a terminal program set the terminal program communication settings to:

```
Baud 9600
Parity None
Flow Control None
Stop Bits 1
```

20. Connect an electrical short (less than 0.00054 ) to all 4 wires of the calibration cable connected to the UUT.

21. Set the UUT password enable by sending the following commands through the serial port:

```
SYST:PASS:CEN XXXX (XXXX is the current UUT password)
```

22. Query the password enable to ensure communication is working and that it is enabled before continuing. Do this by sending the following command:

```
SYST:PASS:CEN?
```

The returned value should be a 1. If not recheck the serial cable connection and the terminal program communication settings listed in step 1.

#### 7.9.1.3.1 L75 Ohms Range

23. Set the UUT in the L75\_OHMS cal range by sending the following commands through the serial port:

```
CAL1:DEV:RANG:SEL L75_OHMS
```

24. Query the reading every 2 seconds for 40 readings using the following command:

```
MEAS?
```

Record the data.

25. Connect a 25 Ohm resistor (28 ppm) to the calibration cable connected to the UUT.
26. Query the reading every 2 seconds for 40 readings using the following command:  
MEAS?  
Record the data.
27. Connect a 75 Ohm resistor to the calibration cable connected to the UUT.
28. Query the reading every 2 seconds for 40 readings using the following command:  
MEAS?  
Record the data.

#### **7.9.1.3.2 Lo Ohms Range**

29. Set the UUT in the LO\_OHMS cal range by sending the following commands through the serial port:  
CAL1:DEV:RANG:SEL LO\_OHMS
30. Connect a 75 Ohm resistor to the calibration cable connected to the UUT.
31. Query the reading every 2 seconds for 40 readings using the following command:  
MEAS?  
Record the data.
32. Connect a 100 Ohm resistor to the calibration cable connected to the UUT.
33. Query the reading every 2 seconds for 40 readings using the following command:  
MEAS?  
Record the data.
34. Connect a 200 Ohm resistor to the calibration cable connected to the UUT.
35. Query the reading every 2 seconds for 40 readings using the following command:  
MEAS?  
Record the data.
36. Connect a 400 Ohm resistor to the calibration cable connected to the UUT.
37. Query the reading every 2 seconds for 40 readings using the following command:  
MEAS?  
Record the data.

**Note:** Steps 38 through 42 apply to the 1524 only. Proceed to step 43 if using a 1523.

38. **(1524 ONLY)** Set Channel T2 of the UUT in the LO\_OHMS cal range by sending the following commands through the serial port:  
CAL2:DEV:RANG:SEL LO\_OHMS

39. Turn off T1 by sending the following command.  
CAL1:DEV:RANGE:SEL NORMAL  
Disconnect resistor.
40. Connect a 100 Ohm resistor to the calibration cable connected to the UUT on Channel T2.
41. Query the reading every 2 seconds for 40 readings using the following command:  
MEAS? 2  
Record the data.
42. Turn off Channel T2 by sending the serial command:  
CAL2:DEV:RANG:SEL NORMAL  
Connect the calibration cable to Channel T1.

### 7.9.1.3.3 Medium Ohms Range

43. Set the UUT in the MED\_OHMS cal range by sending the following commands through the serial port:  
CAL1:DEV:RANG:SEL MED\_OHMS
44. Connect a 200 ohm resistor to the calibration cable connected to the UUT.
45. Query the reading every 2 seconds for 40 readings using the following command:  
MEAS?  
Record the data.
46. Connect a 400 Ohm resistor to the calibration cable connected to the UUT.
47. Query the reading every 2 seconds for 40 readings using the following command:  
MEAS?  
Record the data.
48. Connect a 10K Ohm resistor to the calibration cable connected to the UUT.
49. Query the reading every 2 seconds for 40 readings using the following command:  
MEAS?  
Record the data.
50. Connect a 40K Ohm resistor to the calibration cable connected to the UUT.
51. Query the reading every 2 seconds for 40 readings using the following command:  
MEAS?  
Record the data.

**Note:** Steps 52 through 56 apply to the 1524 only. Proceed to step 57 if using a 1523.

52. **(1524 ONLY)** Set Channel T2 of the UUT in the MED\_OHMS cal range by sending the following commands through the serial port:  
CAL2:DEV:RANG:SEL MED\_OHMS
53. Turn off T1 by sending the following command.  
CAL1:DEV:RANGE:SEL NORMAL  
Disconnect resistor.
54. Connect a 10K Ohm resistor to the calibration cable connected to the UUT on Channel T2.
55. Query the reading every 2 seconds for 40 readings using the following command:  
MEAS? 2  
Record the data.
56. Turn off Channel T2 by sending the serial command:  
CAL2:DEV:RANG:SEL NORMAL  
Connect the calibration cable to Channel T1.

#### **7.9.1.3.4 High Ohms Range**

57. Set the UUT in the HI\_OHMS cal range by sending the following commands through the serial port:  
CAL1:DEV:RANG:SEL HI\_OHMS
58. Connect a 40K Ohm resistor to the calibration cable connected to the UUT.
59. Query the reading every 2 seconds for 40 readings using the following command:  
MEAS?  
Record the data.
60. Connect a 100K Ohm resistor to the calibration cable connected to the UUT.
61. Query the reading every 2 seconds for 40 readings using the following command:  
MEAS?  
Record the data.
62. Connect a 300K Ohm resistor to the calibration cable connected to the UUT.
63. Query the reading every 2 seconds for 40 readings using the following command:  
MEAS?  
Record the data.
64. Connect a 500K Ohm resistor to the calibration cable connected to the UUT.
65. Query the reading every 2 seconds for 40 readings using the following command:  
MEAS?

Record the data.

*Note: Steps 66 through 70 apply to the 1524 only. Proceed to step 71 if using a 1523.*

66. **(1524 ONLY)** Set Channel T2 of the UUT in the HI\_OHMS cal range by sending the following commands through the serial port:

CAL2:DEV:RANG:SEL HI\_OHMS

67. Turn off T1 by sending the following command.

CAL1:DEV:RANGE:SEL NORMAL

Disconnect resistor.

68. Connect a 100K Ohm resistor to the calibration cable connected to the UUT on Channel T2.

69. Query the reading every 2 seconds for 40 readings using the following command:

MEAS? 2

Record the data.

70. Turn off Channel T2 by sending the serial command:

CAL2:DEV:RANG:SEL NORMAL

Connect the calibration cable to Channel T1.

### 7.9.1.3.5 Millivolt Range

71. Set the UUT in the mV cal range by sending the following commands through the serial port:

CAL1:DEV:RANG:SEL MV

72. Connect the voltage source to the calibration cable as described in the Preparation & Settings for Reference readout Calibration section.

73. Set the output of the voltage source to -10 mV.

74. Query the reading every 2 seconds for 40 readings using the following command:

MEAS?

Record the data.

75. Set the output of the voltage source to 0 mV.

76. Query the reading every 2 seconds for 40 readings using the following command:

MEAS?

Record the data.

77. Set the output of the voltage source to 25 mV.

78. Query the reading every 2 seconds for 40 readings using the following command:

MEAS?

Record the data.



79. Set the output of the voltage source to 75 mV.
80. Query the reading every 2 seconds for 40 readings using the following command:  
MEAS?  
Record the data.

### 7.9.1.3.6 Reference Junction Ohms Range

81. Set the UUT in the RJ\_OHMS cal range by sending the following commands through the serial port:  
CAL1:DEV:RANG:SEL RJ\_OHMS
82. Connect a 10K Ohm resistor to the calibration cable connected to the UUT.  
NOTE: Only connect pins 1 and 4 to the 10K Reference resistor. This is a 2 wire test.
83. Query the reading every 2 seconds for 40 readings using the following command:  
MEAS?  
Record the data.
84. For all As Found data, calculate the average and standard deviation for each set of data. Compare the standard deviation to the specification. If the UUT does not meet the standard deviation specification, re-take data at the suspect range(s). If the data is still exceeds the specification, contact an Authorized Service Center for assistance. Verify the average of each data set is less than the Accuracy limit listed in the Accuracy Test Settings and Specification tables.

## 7.9.2 1523/24 Alignment

Prior to performing the alignment, the following UUT configuration and control settings must be set to the values indicated in the 1523/24 Alignment Settings table.



**Caution:** Failure to do this will cause large errors in the measurement readings and invalidate the calibration.

**Table 31** 1523/24 Alignment Settings

Setting	Cal Range	Value	Description
NUM	MV	2	MV Range # of cal points
NUM	L75_OHMS	2	L75_OHMS Range # of cal points
NUM	LO_OHMS	2	LO_OHMS Range # of cal points
NUM	MED_OHMS	2	MED_OHMS Range # of cal points
NUM	HI_OHMS	2	HI_OHMS Range # of cal points
Ref1, Ref2	MV	0, 75	mV Ref Calibration points
Ref1, Ref2	L75_OHMS	0, 75	L75_OHMS Ref Calibration points
Ref1, Ref2	LO_OHMS	75, 400	LO_OHMS Ref Calibration points

## 1523, 1524 Reference Thermometer

### Manual Calibration Process

---

Setting	Cal Range	Value	Description
Ref1, Ref2	MED_OHMS	400, 40000	MED_OHMS Ref Calibration points
Ref1, Ref2	HI_OHMS	40000, 500000	HI_OHMS Ref Calibration points
Adj1 & Adj2	MV	0,0	MV Ref Point Adjustment Values
Adj1 & Adj2	L75_OHMS	0,0	L75_OHMS Ref Point Adjustment Values
Adj1 & Adj2	LO_OHMS	0,0	LO_OHMS Ref Point Adjustment Values
Adj1 & Adj2	MED_OHMS	0,0	MED_OHMS Ref Point Adjustment Values
Adj1 & Adj2	HI_OHMS	0,0	HI_OHMS Ref Point Adjustment Values

**NOTE:** All serial commands below must be sent in the order shown. Not doing so will cause other calibration parameters to change values. This produces large errors in the calibration.

1. Using a terminal program set the terminal program communication settings to:

```
Baud 9600
Parity None
Flow Control None
Stop Bits 1
```

Plug the provided serial communications cable into the UUT.

2. Set the number of Ref points to 2 for each range by sending the following serial commands.

```
SYST:PASS:CEN XXXX (where XXXX is the current UUT password)
CAL:DEV:RANG:SEL L75_OHMS
CAL:DEV:RANG:NUM 2
CAL:DEV:RANG:SEL LO_OHMS
CAL:DEV:RANG:NUM 2
CAL:DEV:RANG:SEL MED_OHMS
CAL:DEV:RANG:NUM 2
CAL:DEV:RANG:SEL HI_OHMS
CAL:DEV:RANG:NUM 2
CAL:DEV:RANG:SEL MV
CAL:DEV:RANG:NUM 2
```

3. Set all Reference points to their designated values (see Table 31 on previous page, 1523/24 Alignment settings) for each range by sending the following commands:

```
CAL:DEV:RANG:SEL L75_OHMS
CAL:DEV:RANGE:REF1 0.0
CAL:DEV:RANGE:REF2 75.0
```

CAL:DEV:RANG:SEL LO\_OHMS  
CAL:DEV:RANGE:REF1 75.0  
CAL:DEV:RANGE:REF2 400.0  
CAL:DEV:RANG:SEL MED\_OHMS  
CAL:DEV:RANGE:REF1 400  
CAL:DEV:RANGE:REF2 40000  
CAL:DEV:RANG:SEL HI\_OHMS  
CAL:DEV:RANGE:REF1 40000  
CAL:DEV:RANGE:REF2 500000  
CAL:DEV:RANG:SEL MV  
CAL:DEV:RANGE:REF1 0.0  
CAL:DEV:RANGE:REF2 75

4. Set all adjustment parameters to 0.0 for each range by sending the following commands:

CAL:DEV:RANG:SEL L75\_OHMS  
CAL:DEV:RANGE:ADJ1 0.0  
CAL:DEV:RANGE:ADJ2 0.0  
CAL:DEV:RANG:SEL LO\_OHMS  
CAL:DEV:RANGE:ADJ1 0.0  
CAL:DEV:RANGE:ADJ2 0.0  
CAL:DEV:RANG:SEL MED\_OHMS  
CAL:DEV:RANGE:ADJ1 0.0  
CAL:DEV:RANGE:ADJ2 0.0  
CAL:DEV:RANG:SEL HI\_OHMS  
CAL:DEV:RANGE:ADJ1 0.0  
CAL:DEV:RANGE:ADJ2 0.0  
CAL:DEV:RANG:SEL MV  
CAL:DEV:RANGE:ADJ1 0.0  
CAL:DEV:RANGE:ADJ2 0.0

5. Take alignment data by following (or repeating) the steps in the As Found Data section. Do not take alignment data for Channel T2.
6. Calculate the average and the standard deviation of the alignment data..
7. Calculate the adjustment values for each range and record the value using the formula below:

$$ADJ_x = \text{average} - \text{nominal}$$

X represents which ADJ value for that range, 1 or 2

Average is the average of the 40 measured samples at one reference point.

Nominal is the exact known value of the reference resistor or voltage source.

The following are the individual formulas for each ADJ value:

**7.9.2.1 L75\_OHMS Range**

ADJ1 = ave0  $\Omega$  – 0  $\Omega$  nominal

ADJ2 = ave75  $\Omega$  – 75  $\Omega$  nominal

**7.9.2.2 LO\_OHMS Range**

ADJ1 = ave75  $\Omega$  – 75  $\Omega$  nominal

ADJ2 = ave400  $\Omega$  – 400  $\Omega$  nominal

**7.9.2.3 MED\_OHMS Range**

ADJ1 = ((ave400 $\Omega$  – 400 $\Omega$  nominal) + ((ave40,000 $\Omega$  – 40,000 $\Omega$  nominal)\*0.005)+ (ave200 $\Omega$  – 200 $\Omega$  nominal))/2

ADJ2 = ave40,000 $\Omega$  – 40,000 $\Omega$  nominal

**7.9.2.4 HI\_OHMS Range**

ADJ1 = ave40,000 $\Omega$  – 40,000 $\Omega$  nominal

ADJ2 = 0.8333 (ave300,000 $\Omega$  – 300,000 $\Omega$  nominal) + 0.5(ave500,000 $\Omega$  – 500,000 $\Omega$  nominal)

**7.9.2.5 Millivolt Range**

ADJ1 = ave0mV – 0mV nominal

ADJ2 = ave75mV – 75mV nominal

8. Send the calculated ADJ values from step 7 to the UUT using the following serial commands. The XXXX represents the new calculated value.

```
CAL:DEV:RANG:SEL L75_OHMS
```

```
CAL:DEV:RANGE:ADJ1 XXXX
```

```
CAL:DEV:RANGE:ADJ2 XXXX
```

```
CAL:DEV:RANG:SEL LO_OHMS
```

```
CAL:DEV:RANGE:ADJ1 XXXX
```

```
CAL:DEV:RANGE:ADJ2 XXXX
```

```
CAL:DEV:RANG:SEL MED_OHMS
```

```
CAL:DEV:RANGE:ADJ1 XXXX
```

```
CAL:DEV:RANGE:ADJ2 XXXX
```

```
CAL:DEV:RANG:SEL HI_OHMS
```

```
CAL:DEV:RANGE:ADJ1 XXXX
```

```
CAL:DEV:RANGE:ADJ2 XXXX
```

CAL:DEV:RANG:SEL MV

CAL:DEV:RANGE:ADJ1 XXXX

CAL:DEV:RANGE:ADJ2 XXXX

### **7.9.3 1523/24 As Left Test Data**

1. Take as Left data by following the steps in the As Found Data section.
2. Calculate the average and the standard deviation of the measurements taken in step 1, including the Channel T2 data. Record the results.
3. Compare the error with the specification in the Accuracy Test Setting and Specification tables for each range to determine the pass/fail status. Record the result.



## 8 Troubleshooting

Below are several situations that may arise followed by possible causes of the problem and suggested actions. If you can not resolve the problem, contact an Authorized Service Center. (See Section 1.8, Authorized Service Centers on page 5.)

Problem	Solution
<b>“Battery Symbol” is displayed</b>	The battery is low and needs to be changed. When this symbol appears, the batteries should be replaced to ensure the accuracy of readings.
<b>“Waiting for Data” is displayed when a probe is plugged in.</b>	The instrument is unable to detect that a probe is connected. Check that a probe with a properly programmed INFO-CON connector is attached.
<b>“locked” is displayed</b>	<b>The incorrect probe is attached to the unit or channel in the case of the 1524.</b> The meter is set to accept only the probe with the given serial number to the specified channel. Attach the correct probe or have the instrument properly programmed for the new probe. See Section 3.4, Probe Lock Function on page 25.
<b>Cannot change INFO-CON settings using the 9940 software or manually through the serial port.</b>	<b>The pass code entered was not correct.</b> Note: The factory set pass code is 1234.
<b>The instrument display is blank when it should show measurements.</b>	<b>Make sure the instrument has power, either from the batteries or the AC adapter.</b> Verify that the initialization information appears on the display when the power is switched on. Check to make sure that a probe is properly connected. Check to make sure that the INFO-CON connector is programmed properly using the 9940 software.
<b>While attempting to measure resistance the display shows an incorrect or erratic value.</b>	<b>Poor or incorrect connection of the probe.</b> A common mistake is to connect the wires of the probe to the wrong terminals. Check the wiring carefully (see Figure 16 on page 27). <b>Open, shorted, or damaged sensor or lead wires.</b> Check the resistance across the sensor using a handheld digital multi-meter. Check the resistance between common pairs of leads. Check to make sure there is no conductivity between any of the leads and the probe sheath. Use a good-quality sensor to avoid errors caused by drift, hysteresis, or insulation leakage. <b>Stem conduction error.</b> Make sure the stem of the probe is immersed in the medium with adequate depth and a tight fit. <b>Electrical interference.</b> Intense radio frequency radiation near the thermometer or the probe can induce noise into the measurement circuits resulting in erratic readings. Try eliminating the source of interference or moving the thermometer to a different location.





## 9 Maintenance

This instrument has been designed with the utmost care. Ease of operation and simplicity of maintenance have been a central theme in the product development. With proper care the instrument should require very little maintenance. Avoid operating the instrument in oily, wet, dirty, or dusty environments.

If the outside of the instrument becomes soiled, it may be wiped clean with a damp cloth and mild detergent. Do not use harsh chemicals on the surface which may damage the LCD or the plastic outside shell.

If a hazardous material is spilled on or inside the equipment, the user is responsible for taking the appropriate decontamination steps as outlined by the national safety council with respect to the material.

Before using any cleaning or decontamination method except those recommended by Fluke, users should check with an Authorized Service Center to ensure that the proposed method will not damage the equipment.

If the AC adapter becomes damaged, have it replaced immediately. Never disassemble the AC adapter or attempt to repair it.

If the instrument is used in a manner not in accordance with the equipment design, the operation of the thermometer may be impaired or safety hazards may arise.

**Note:** Use only AA alkaline batteries.



---

# Index

## Symbols

1523/24 Alignment 89  
9940 software 43  
\*CLS 49  
°F, °C 29  
\*IDN? 49  
\*RST 50  
Ω mV 36

## A

AC adapter 23, 97  
AC Adapter 81  
Accuracy Test 84  
action commands 76  
Alignment Procedur 80  
Alignment Test Data 80  
ARROWS, UP, DOWN 34  
As Found 82  
As Found Data 80  
As Left Data 80  
As Left Test Data 93  
Authorized Service Center 77  
Authorized Service Centers 5  
Auto Log 41  
Auto-Log 35, 37  
AUTO-LOG 39  
Auto-Off 33, 81

## B

Battery 23  
battery icon 23  
Baud Rate 34  
buffer capacity 45

## C

CALCulate:AVERage:CLEar 50  
CALCulate:AVERage<n>:TYPE? 50  
CALCulate<prb>:AVERage<n>:DATA? 50  
CALCulate<prb>:CONVert:DATE:CALibrate?  
50

CALCulate<prb>:CONVert:DATE:CALibrate  
<year>,<month>,<day 50  
CALCulate<prb>:CONVert:IDENTity? 53  
CALCulate<prb>:CONVert:IDENTity <num> 53  
CALCulate<prb>:CONVert:NAM <conv 51  
CALCulate<prb>:CONVert:NAME? 51  
CALCulate<prb>:CONVert:PARAmeter:CATal  
og? 51  
CALCulate<prb>:CONVert:PARAmeter:VALue?  
<param> 52  
CALCulate<prb>:CONVert:PARAmeter:VALue  
<param>,<num> 52  
CALCulate<prb>:CONVert:SNUMber? 52  
CALCulate<prb>:CONVert:SNUMber <seri 52  
CALCulate<prb>:CONVert:TEST?  
<res>|<mv>[,<rtj 53  
CALCulate<prb>:CONVert:UPDat 53  
CALCulate<prb>:CONVert:VERSion? 54  
CALCulate<prb>:CONVert:VERSion <num> 54  
CALibrate<chn>:DEVICE:LOCK? 54  
CALibrate<chn>:DEVICE:LOCK<bool 55  
CALibrate<chn>:DEVICE:LOCK:DATA? 55  
CALibrate<chn>:DEVICE:RANGe:CLEar 56  
CALibrate<chn>:DEVICE:RANGe:SELECTION? 58  
CALibrate<chn>:DEVICE:RANGe:SELECTION  
<val> 58  
CALibrate:DEVICE:AUTO? 54  
CALibrate:DEVICE:AUTO <val> 54  
CALibrate:DEVICE:RANGe:ADJust<num>? 55  
CALibrate:DEVICE:RANGe:ADJust<num> <val  
56  
CALibrate:DEVICE:RANGe:NUMber? 56  
CALibrate:DEVICE:RANGe:NUMber <val> 57  
CALibrate:DEVICE:RANGe:REFerence<num>?  
57  
CALibrate:DEVICE:RANGe:REFerence<num>  
<val 57  
Calibration 77  
Calibration and Setup Commands 45  
Calibration Equipment 77  
Calibration Parameters 82  
Calibration Process 81  
Calibration Range Identifiers 75  
Channel T1 Setup 30  
Channel T2 Setup 30

Clamp-On Ferrites 4  
cleaning 97  
Commands, Calibration and Setup 45  
Commands, Data Logging 45  
Commands, Measurement 45  
Commands, Probe Setup 45  
Commands, Serial 48  
Commands, Status and Event 45  
Commands, System 45  
Contrast 33

### **D**

Data Logging Commands 45  
Data Upload Format 41  
Date/Time 34  
Demand Log 35  
DEMAND LOG 39  
DISPlay<chn>:RESolution? 58  
DISPlay<chn>:RESolution <num> 58  
Display Functions 29

### **E**

ENTER 35  
error message 76  
Error Messages 76

### **F**

Fast Scan Mod 33  
Fast Scan Mode 40, 81  
ferrite 4  
FETCh? <prb> 59

### **H**

High Ohms Range 87  
HI\_OHMS Range 92  
HOLD 29  
HOME 38

### **I**

INFO-CON 24, 26  
Interval 37

### **L**

L75 Ohms Range 84  
L75\_OHMS Range 92

LOG 37  
LOG Full 40  
LOGging:AUTomatic:DELeTe <num> 59  
LOGging:AUTomatic:FREE? 59  
LOGging:AUTomatic:LABel? 59  
LOGging:AUTomatic:LABel <num> 60  
LOGging:AUTomatic:POINt? 60  
LOGging:AUTomatic:PRINt <num> 60  
LOGging:AUTomatic:STATus? 61  
LOGging:AUTomatic:STATus <bool> 61  
LOGging:AUTomatic:TIME? 61  
LOGging:AUTomatic:TIME <rate> 62  
LOGging:AUTomatic:VALue? <num> 62  
LOGging:DEMAND:DELeTe 62  
LOGging:DEMAND:FREE? 63  
LOGging:DEMAND:POINt? 63  
LOGging:DEMAND:PRINt 63  
LOGging:DEMAND:STATistic<n>? <num> 64  
LOGging:DEMAND:VALue? <num> 64  
LOGging:LABel<n>:NAME? 65  
LOGging:LABel<n>:NAME <label> 65  
LOGS 39  
Lo Ohms Range 85  
LO\_OHMS Range 92

### **M**

Maintenance 97  
Measurement Commands 45  
MEASure? <prb> 66  
Medium Ohms Range 86  
Menu, 1523 11  
Menu, 1524 14  
Millivolt Range 88, 92

### **N**

NEXT 36

### **P**

Probe 24  
Probe Lock 25  
Probe parameters 45  
Probe Setup Commands 45  
Probe wiring diagrams 27  
PRTs 24

---

## Q

query commands 76

## R

READ? <prb 66

RECALL 35

reference junction compensation 31

Reference Junction Ohms Range 89

RESET 36

RS-232 43

## S

Safety Information 1

SAVE 34

SENSe:DATA:RJ? 67

SENSe<prb>:DATA:MV? 66

SENSe<prb>:DATA:OHMS? 66

SENSe:RJ:STATe 67

SENSe:RJ:TEMPeRature? 67

SENSe:RJ:TEMP <val> 67

serial commands 90

Serial Communication 80

Serial Operation 44

SETUP 30

SHIFT 36

Specifications 17

Standard Equipment 1

STATS 29

Status and Event Commands 45

STATus:MEASure:CONDition? 68

STATus:MEASure:ENABle? 68

STATus:MEASure:ENABle <num> 68

STATus:MEASure:EVENT? 67

STATus:QUESTionable:CONDition? 69

STATus:QUESTionable:ENABle 69

STATus:QUESTionable:ENABle <num> 69

STATus:QUESTionable:EVENT? 68

Syntax, Command 44

System Commands 45

SYSTem:COMMunicate:SERial:BAUD? 69

SYSTem:COMMunicate:SERial:BAUD <baud>

70

SYSTem:COMMunicate:SERial:OFF 70

SYSTem:DATE? 70

SYSTem:DATE <year>,<month>,<day> 70

SYSTem:ERRor? 71

SYSTem:PASSword:CDISable 71

SYSTem:PASSword:CENable <pass> 71

SYSTem:PASSword:CENable:STATe? 71

SYSTem:PASSword:NEW <pass> 71

SYSTem:SNUMber? 72

SYSTem:TIME? 72

SYSTem:TIME <hour>,<minute>,<second> 72

SYSTem:VERSion? 72

## T

Tag 38

Thermistors 24

Thermocouple 24

TREND 36

Troubleshooting 95

## U

UNIT:TEMPeRature? 73

UNIT:TEMPeRature <unit> 73

Unit Under Test 77

User Interface 29

## V

Visual Inspection 82

