

# DFMC 0,5/ 6-ST-2,54 - PCB connector



1844617

<https://www.phoenixcontact.com/us/products/1844617>

Please be informed that the data shown in this PDF document is generated from our online catalog. Please find the complete data in the user documentation. Our general terms of use for downloads are valid.

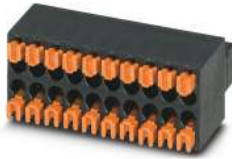

PCB connector, nominal cross section: 0.5 mm<sup>2</sup>, color: black, nominal current: 6 A, rated voltage (III/2): 160 V, contact surface: Gold, contact connection type: Socket, number of potentials: 12, number of rows: 2, number of positions: 6, number of connections: 12, product range: DFMC 0,5/..-ST, pitch: 2.54 mm, connection method: Push-in spring connection, conductor/PCB connection direction: 0 °, plug-in system: COMBICON DFMC 0,5, locking: without, mounting: without, type of packaging: packed in cardboard

## Your advantages

- Gold-plated contacts ensure transfer quality remains stable over the long term
- Time saving push-in connection, tools not required
- Defined contact force ensures that contact remains stable over the long term
- Intuitive use through colour coded actuation lever
- Optimized for tight installation situations: operation and conductor connection from one direction

## Commercial data

Item number	1844617
Packing unit	1 pc
Minimum order quantity	100 pc
Sales key	AA01
Product key	AAAFDA
GTIN	4046356964289
Weight per piece (including packing)	3.03 g
Weight per piece (excluding packing)	3.03 g
Customs tariff number	85366990
Country of origin	PL

# DFMC 0,5/ 6-ST-2,54 - PCB connector



1844617

<https://www.phoenixcontact.com/us/products/1844617>

## Technical data

### Product properties

Type	Standard
Product line	COMBICON Connectors XS
Product type	PCB connector
Product family	DFMC 0,5/..-ST
Number of positions	6
Pitch	2.54 mm
Number of connections	12
Number of rows	2
Mounting flange	without
Number of potentials	12

### Electrical properties

Nominal current $I_N$	6 A
Nominal voltage $U_N$	160 V
Degree of pollution	3
Contact resistance	2.7 m $\Omega$
Rated voltage (III/3)	32 V
Rated surge voltage (III/3)	2.5 kV
Rated voltage (III/2)	160 V
Rated surge voltage (III/2)	2.5 kV
Rated voltage (II/2)	160 V
Rated surge voltage (II/2)	2.5 kV

### Connection data

#### Connection technology

Type	Standard
Connector system	COMBICON DFMC 0,5
Nominal cross section	0.5 mm <sup>2</sup>
Contact connection type	Socket

#### Interlock

Locking type	without
Mounting flange	without

#### Conductor connection

Connection method	Push-in spring connection
Conductor/PCB connection direction	0 °
Conductor cross section rigid	0.14 mm <sup>2</sup> ... 0.5 mm <sup>2</sup>
Conductor cross section flexible	0.14 mm <sup>2</sup> ... 0.5 mm <sup>2</sup>
Conductor cross section AWG	26 ... 20
Conductor cross section flexible, with ferrule without plastic	0.25 mm <sup>2</sup> ... 0.34 mm <sup>2</sup>

# DFMC 0,5/ 6-ST-2,54 - PCB connector

1844617

<https://www.phoenixcontact.com/us/products/1844617>

sleeve	
Conductor cross section, flexible, with ferrule, with plastic sleeve	0.14 mm <sup>2</sup> ... 0.25 mm <sup>2</sup>
Cylindrical gauge a x b / diameter	- / 1.2 mm
Stripping length	7 mm

## Material specifications

### Material data - contact

Note	WEEE/RoHS-compliant, free of whiskers according to IEC 60068-2-82/JEDEC JESD 201
Contact material	Cu alloy
Surface characteristics	Selective coating
Metal surface terminal point (top layer)	Tin (5 - 7 µm Sn)
Metal surface terminal point (middle layer)	Nickel (1 - 3 µm Ni)
Metal surface contact area (top layer)	Gold (0.25 Au)
Metal surface contact area (middle layer)	Nickel (2 - 3 µm Ni)

### Material data - housing

Color (Housing)	black (9005)
Insulating material	LCP
Insulating material group	IIIa
CTI according to IEC 60112	175
Flammability rating according to UL 94	V0

### Material data - actuating element

Color (Actuating element)	orange (2003)
Insulating material	LCP
Insulating material group	IIIa
CTI according to IEC 60112	175
Flammability rating according to UL 94	V0

## Dimensions

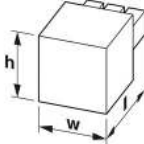
Dimensional drawing	
Pitch	2.54 mm
Width [w]	15.74 mm
Height [h]	10.5 mm
Length [l]	15.85 mm

## Mounting

Connection method	Push-in spring connection
-------------------	---------------------------

## Mechanical tests

### Conductor connection

Specification	IEC 60999-1:1999-11
Result	Test passed

### Test for conductor damage and slackening

Specification	IEC 60999-1:1999-11
Result	Test passed

### Repeated connection and disconnection

Specification	IEC 60999-1:1999-11
Result	Test passed

### Pull-out test

Specification	IEC 60999-1:1999-11
Conductor cross section/conductor type/tractive force setpoint/actual value	0.14 mm <sup>2</sup> / solid / > 10 N
	0.14 mm <sup>2</sup> / flexible / > 10 N
	0.5 mm <sup>2</sup> / solid / > 20 N
	0.5 mm <sup>2</sup> / flexible / > 20 N

### Insertion and withdrawal forces

Result	Test passed
No. of cycles	100
Insertion strength per pos. approx.	2 N
Withdraw strength per pos. approx.	1 N

### Resistance of inscriptions

Specification	IEC 60068-2-70:1995-12
Result	Test passed

### Polarization and coding

Specification	IEC 60512-13-5:2006-02
Result	Test passed

### Visual inspection

Specification	IEC 60512-1-1:2002-02
Result	Test passed

### Dimension check

Specification	IEC 60512-1-2:2002-02
Result	Test passed

## Environmental and real-life conditions

### Vibration test

Specification	IEC 60068-2-6:2007-12
Frequency	10 - 500 - 10 Hz

# DFMC 0,5/ 6-ST-2,54 - PCB connector



1844617

<https://www.phoenixcontact.com/us/products/1844617>

Sweep speed	1 octave/min
Amplitude	0.35 mm (10 Hz ... 60.1 Hz)
Sweep speed	5g (60.1 Hz ... 500 Hz)
Test duration per axis	2 h

## Durability test

Specification	IEC 60512-9-1:2010-03
Impulse withstand voltage at sea level	2.95 kV
Contact resistance R <sub>1</sub>	2.7 mΩ
Contact resistance R <sub>2</sub>	2.9 mΩ
Contact resistance R <sub>2</sub> 2nd level	3.1 mΩ
Insertion/withdrawal cycles	100
Insulation resistance, neighboring positions	> 5 MΩ

## Climatic test

Specification	DIN 50018:2013-05
Corrosive stress	1.0 dm <sup>3</sup> SO <sub>2</sub> on 300 dm <sup>3</sup> /40 °C/3 cycles
Thermal stress	100 °C/168 h
Power-frequency withstand voltage	1.39 kV

## Ambient conditions

Ambient temperature (operation)	-40 °C ... 100 °C (dependent on the derating curve)
Ambient temperature (storage/transport)	-40 °C ... 70 °C
Relative humidity (storage/transport)	30 % ... 70 %
Ambient temperature (assembly)	-5 °C ... 100 °C

## Electrical tests

### Thermal test | Test group C

Specification	IEC 60512-5-1:2002-02
Tested number of positions	16

### Insulation resistance

Specification	IEC 60512-3-1:2002-02
Insulation resistance, neighboring positions	> 5 MΩ

### Temperature cycles

Specification	IEC 60999-1:1999-11
Result	Test passed

### Air clearances and creepage distances |

Specification	IEC 60664-1:2007-04
Insulating material group	IIIa
Comparative tracking index (IEC 60112)	CTI 175
Rated insulation voltage (III/3)	32 V
Rated surge voltage (III/3)	2.5 kV
minimum clearance value - non-homogenous field (III/3)	1.5 mm

# DFMC 0,5/ 6-ST-2,54 - PCB connector



1844617

<https://www.phoenixcontact.com/us/products/1844617>

minimum creepage distance (III/3)	1.3 mm
Rated insulation voltage (III/2)	160 V
Rated surge voltage (III/2)	2.5 kV
minimum clearance value - non-homogenous field (III/2)	1.5 mm
minimum creepage distance (III/2)	1.6 mm
Rated insulation voltage (II/2)	160 V
Rated surge voltage (II/2)	2.5 kV
minimum clearance value - non-homogenous field (II/2)	1.5 mm
minimum creepage distance (II/2)	1.6 mm

## Packaging specifications

Type of packaging	packed in cardboard
-------------------	---------------------

Drawings

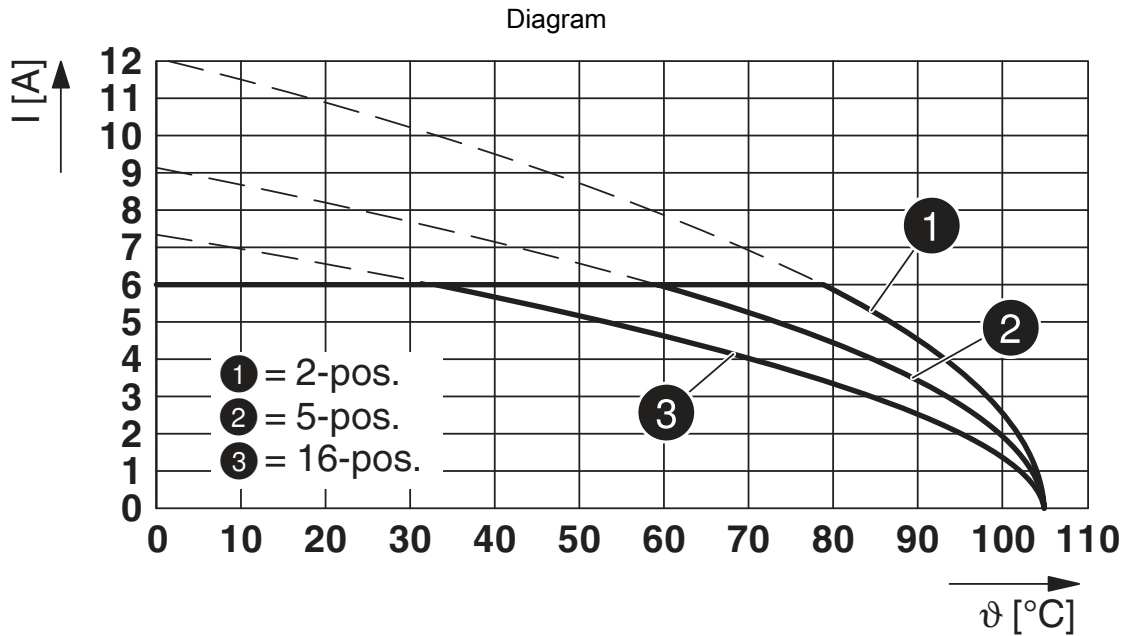

Type: DFMC 0,5/...-ST-2,54 with DMCV 0,5/...-G1-2,54 SMD R...

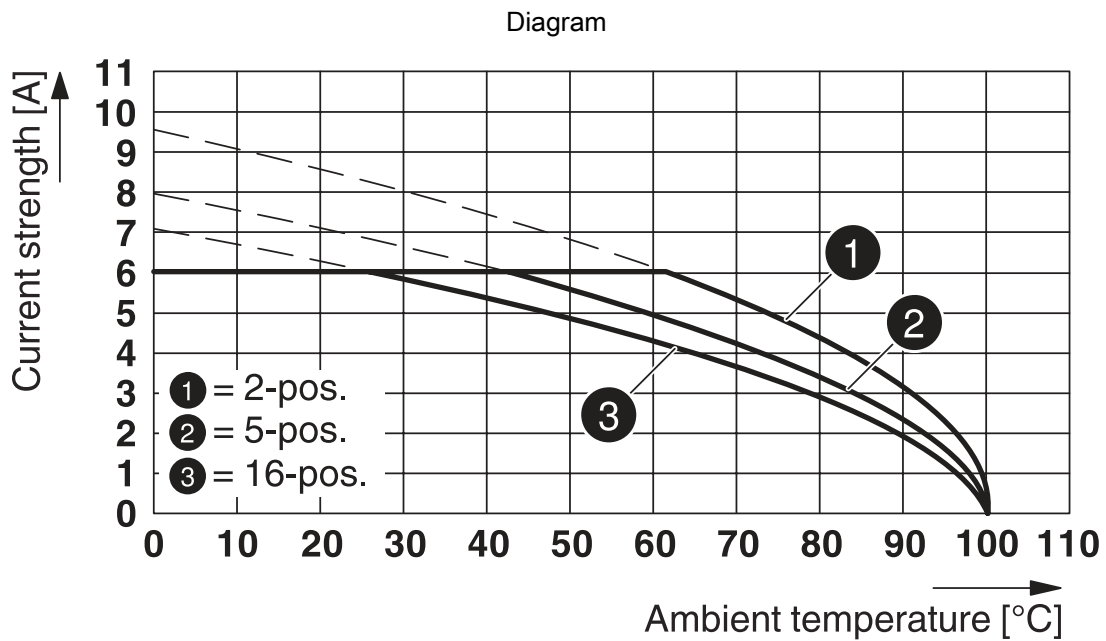

Type: DFMC 0,5/...-ST-2,54 with DMC 0,5/...-G1-2,54 P...THR R...

# DFMC 0,5/ 6-ST-2,54 - PCB connector



1844617

<https://www.phoenixcontact.com/us/products/1844617>

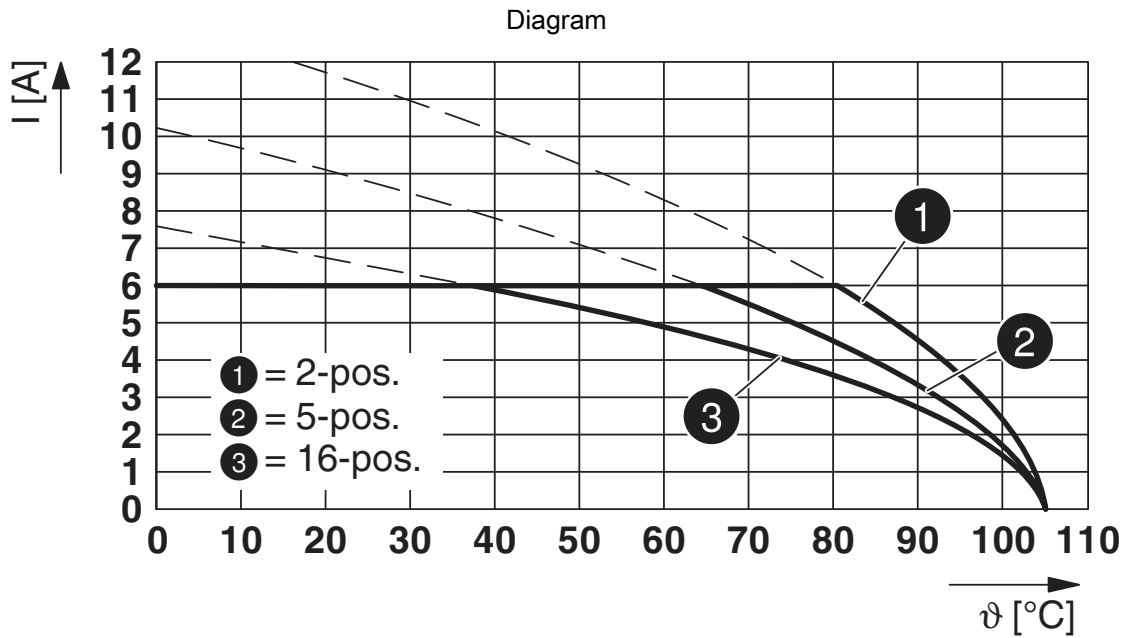

Type: DFMC 0,5/...-ST-2,54 with DMC 0,5/...-G1-2,54 SMD R...

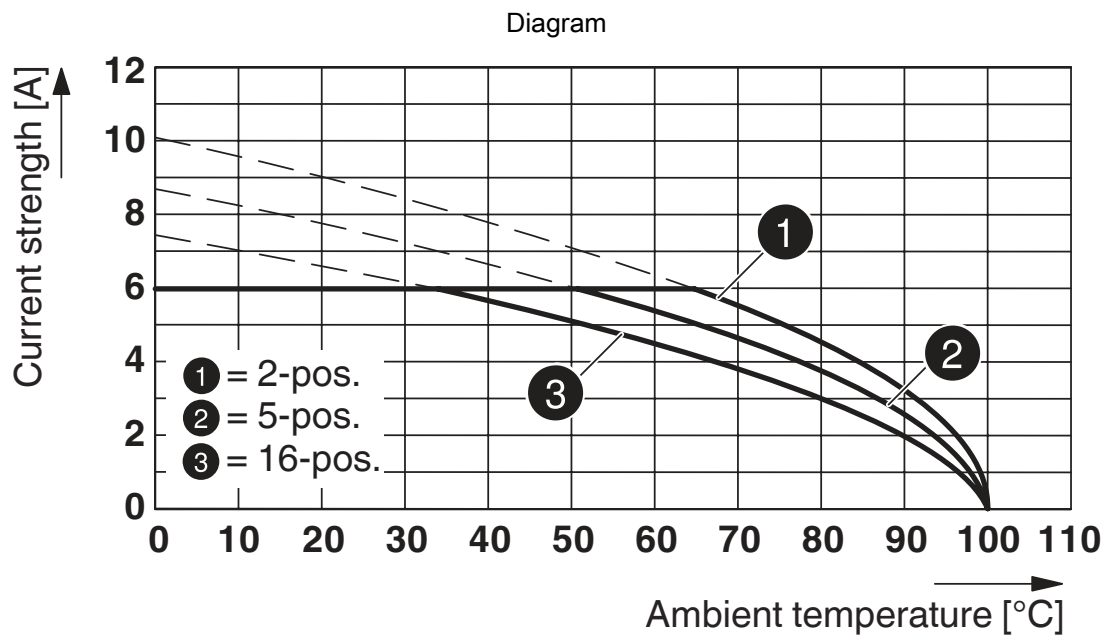

Type: DFMC 0,5/...-ST-2,54 with DMCV 0,5/...-G1-2,54 P... THRR...



# DFMC 0,5/ 6-ST-2,54 - PCB connector





1844617

<https://www.phoenixcontact.com/us/products/1844617>

## Approvals

To download certificates, visit the product detail page: <https://www.phoenixcontact.com/us/products/1844617>

 <b>IECEE CB Scheme</b> Approval ID: DE1-55740	Nominal voltage $U_N$	Nominal current $I_N$	Cross section AWG	Cross section $\text{mm}^2$
	160 V	6 A	-	0.14 - 0.5

 <b>EAC</b> Approval ID: B.01687
--

 <b>cULus Recognized</b> Approval ID: E60425-19920306	Nominal voltage $U_N$	Nominal current $I_N$	Cross section AWG	Cross section $\text{mm}^2$
Use group B				
Field wiring	150 V	5 A	26 - 20	-
Factory wiring	150 V	6 A	26 - 20	-
Use group C				
Factory wiring	50 V	6 A	26 - 20	-

 <b>VDE Gutachten mit Fertigungsüberwachung</b> Approval ID: 40042389	Nominal voltage $U_N$	Nominal current $I_N$	Cross section AWG	Cross section $\text{mm}^2$
	160 V	6 A	-	0.14 - 0.5

# DFMC 0,5/ 6-ST-2,54 - PCB connector



1844617

<https://www.phoenixcontact.com/us/products/1844617>

## Classifications

### ECLASS

ECLASS-11.0	27460202
ECLASS-12.0	27460202
ECLASS-13.0	27460202

### ETIM

ETIM 8.0	EC002638
----------	----------

### UNSPSC

UNSPSC 21.0	39121400
-------------	----------

# DFMC 0,5/ 6-ST-2,54 - PCB connector



1844617

<https://www.phoenixcontact.com/us/products/1844617>

## Environmental product compliance

China RoHS	Environmentally friendly use period: unlimited = EFUP-e
	No hazardous substances above threshold values

# DFMC 0,5/ 6-ST-2,54 - PCB connector

1844617

<https://www.phoenixcontact.com/us/products/1844617>

## Accessories

### SZS 0,4X2,0 - Screwdriver

1205202

<https://www.phoenixcontact.com/us/products/1205202>



Micro screwdriver, bladed, size: 0.4 x 2.0 x 60 mm, 2-component grip, with non-slip grip and twist cap

---

### SK 2,54/2,8:FORTL.ZAHLEN - Marker card

0804853

<https://www.phoenixcontact.com/us/products/0804853>



Marker card, white, labeled, horizontal: consecutive numbers 1 ... 10, 11 ... 20, etc. up to 91 ... 99, mounting type: adhesive, for terminal block width: 2.54 mm, lettering field size: 2.54 x 2.8 mm

# DFMC 0,5/ 6-ST-2,54 - PCB connector

1844617

<https://www.phoenixcontact.com/us/products/1844617>

## A 0,25- 7 - Ferrule

3202478

<https://www.phoenixcontact.com/us/products/3202478>



Ferrule, length: 7 mm, color: silver

---

## A 0,34- 7 - Ferrule

3009202

<https://www.phoenixcontact.com/us/products/3009202>



Ferrule, length: 7 mm, color: silver

# DFMC 0,5/ 6-ST-2,54 - PCB connector

1844617

<https://www.phoenixcontact.com/us/products/1844617>

## CRIMPFOX 6 - Crimping pliers

1212034

<https://www.phoenixcontact.com/us/products/1212034>



Crimping pliers, for ferrules without insulating collar according to DIN 46228 Part 1 and ferrules with insulating collar according to DIN 46228 Part 4, 0.25 mm<sup>2</sup> ... 6.0 mm<sup>2</sup>, lateral entry, trapezoidal crimp

---

## DMC 0,5/ 6-G1-2,54 P20THR R44 - PCB header

1844769

<https://www.phoenixcontact.com/us/products/1844769>



PCB headers, nominal cross section: 0.5 mm<sup>2</sup>, color: black, nominal current: 6 A, rated voltage (III/2): 160 V, contact surface: Gold, contact connection type: Pin, number of potentials: 12, number of rows: 2, number of positions: 6, number of connections: 12, product range: DMC 0,5/..-G1-THR, pitch: 2.54 mm, mounting: THR soldering, pin layout: Linear pinning, solder pin [P]: 2 mm, number of solder pins per potential: 1, plug-in system: COMBICON DFMC 0,5, Pin connector pattern alignment: Standard, locking: without, mounting: without, type of packaging: 44 mm wide tape, Sample values available under SAMPLE DMC...

## DFMC 0,5/ 6-ST-2,54 - PCB connector

1844617

<https://www.phoenixcontact.com/us/products/1844617>

### DMCV 0,5/ 6-G1-2,54 P20THR R44 - PCB header

1844918

<https://www.phoenixcontact.com/us/products/1844918>



PCB headers, nominal cross section: 0.5 mm<sup>2</sup>, color: black, nominal current: 6 A, rated voltage (III/2): 160 V, contact surface: Gold, contact connection type: Pin, number of potentials: 12, number of rows: 2, number of positions: 6, number of connections: 12, product range: DMCV 0,5/..-G1-THR, pitch: 2.54 mm, mounting: THR soldering, pin layout: Linear pinning, solder pin [P]: 2 mm, number of solder pins per potential: 1, plug-in system: COMBICON DFMC 0,5, Pin connector pattern alignment: Standard, locking: without, mounting: without, type of packaging: 44 mm wide tape, Sample values available under SAMPLE DMC...

### DMC 0,5/ 6-G1-2,54 SMD R44 - PCB header

1845069

<https://www.phoenixcontact.com/us/products/1845069>



PCB headers, nominal cross section: 0.5 mm<sup>2</sup>, color: black, nominal current: 6 A, rated voltage (III/2): 160 V, contact surface: Gold, contact connection type: Pin, number of potentials: 12, number of rows: 2, number of positions: 6, number of connections: 12, product range: DMC 0,5/..-G1-SMD, pitch: 2.54 mm, mounting: SMD soldering, pin layout: Linear pinning, solder pin [P]: 2 mm, number of solder pins per potential: 1, plug-in system: COMBICON DFMC 0,5, Pin connector pattern alignment: Standard, locking: without, mounting: without, type of packaging: 44 mm wide tape, Sample values available under SAMPLE DMC...

# DFMC 0,5/ 6-ST-2,54 - PCB connector



1844617

<https://www.phoenixcontact.com/us/products/1844617>

## DMCV 0,5/ 6-G1-2,54 SMD R44 - PCB header

1845218

<https://www.phoenixcontact.com/us/products/1845218>



PCB headers, nominal cross section: 0.5 mm<sup>2</sup>, color: black, nominal current: 6 A, rated voltage (III/2): 160 V, contact surface: Gold, contact connection type: Pin, number of potentials: 12, number of rows: 2, number of positions: 6, number of connections: 12, product range: DMCV 0,5/...-G1-SMD, pitch: 2.54 mm, mounting: SMD soldering, pin layout: Linear pinning, solder pin [P]: 2 mm, number of solder pins per potential: 1, plug-in system: COMBICON DFMC 0,5, Pin connector pattern alignment: Standard, locking: without, mounting: without, type of packaging: 44 mm wide tape, Sample values available under SAMPLE DMC...

---

Phoenix Contact 2023 © - all rights reserved

<https://www.phoenixcontact.com>

Phoenix Contact USA  
586 Fulling Mill Road  
Middletown, PA 17057, United States  
(+717) 944-1300  
[info@phoenixcon.com](mailto:info@phoenixcon.com)