4 MHz PWM 2A Buck Regulator with HyperLight Load[®] and Power Good

Features

- Input Voltage: 2.7V to 5.5V
- Output Voltage: Fixed or Adjustable (0.62V to 3.6V)
- Up to 2A Output Current
- Up to 93% Peak Efficiency
- 85% Typical Efficiency at 1 mA
- Power Good (PG) Output
- Programmable Soft-Start
- 22 μ A Typical Quiescent Current
- 4 MHz PWM Operation in Continuous Mode
- Ultra-Fast Transient Response
- Low Ripple Output Voltage:
 - 35 mV_{PP} Ripple in HyperLight Load[®] Mode
 - 5 mV Output Voltage Ripple in Full PWM Mode
- Fully Integrated MOSFET Switches
- 0.01 μ A Shutdown Current
- Thermal Shutdown and Current Limit Protection
- 10-Pin 2.5 mm x 2.5 mm Thin DFN Package
- -40°C to +125°C Junction Temperature Range

Applications

- Solid State Drives (SSD)
- Mobile Handsets
- Portable Media/MP3 Players
- Portable Navigation Devices (GPS)
- WiFi/WiMax/WiBro Modules
- Wireless LAN Cards
- Portable Applications

General Description

The MIC23153 is a high-efficiency 4 MHz 2A synchronous buck regulator with HyperLight Load[®] mode, Power Good (PG) output indicator, and programmable soft-start. HyperLight Load[®] provides very high efficiency at light loads and ultra-fast transient response that makes the MIC23153 perfectly suited for supplying processor core voltages.

An additional benefit of this proprietary architecture is very low output ripple voltage throughout the entire load range with the use of small output capacitors. The tiny 2.5 mm x 2.5 mm thin DFN package saves precious board space and requires only four external components.

The MIC23153 is designed for use with a very small inductor, down to 0.47 μ H, and an output capacitor as small as 2.2 μ F that enables a total solution size, less than 1 mm in height.

The MIC23153 has a very-low quiescent current of 22 μ A and achieves a peak efficiency of 93% in continuous conduction mode. In discontinuous conduction mode, the MIC23153 can achieve 85% efficiency at 1 mA.

The MIC23153 is available in 10-pin 2.5 mm x 2.5 mm TDFN package with an operating junction temperature range from -40°C to +125°C.

MIC23153

Package Types

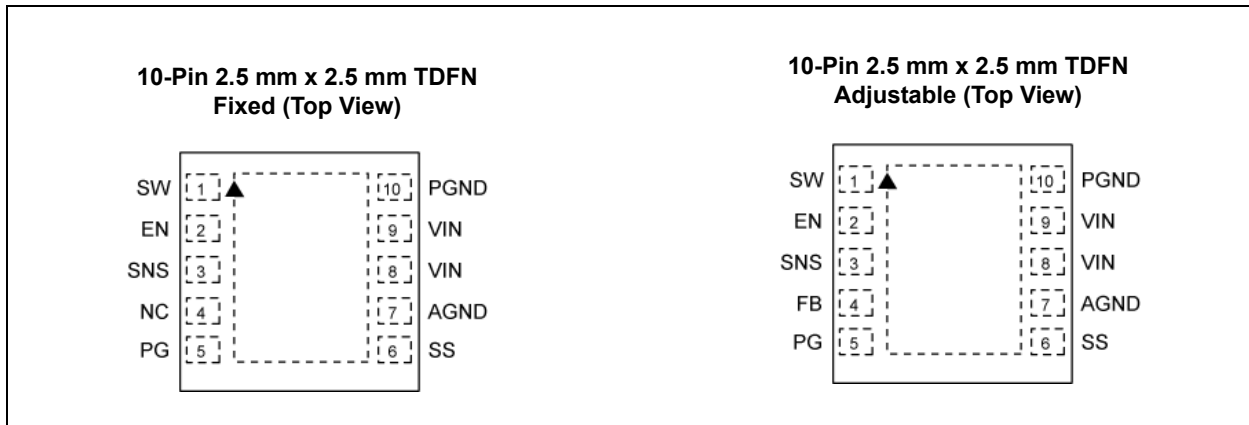

Typical Application Circuits

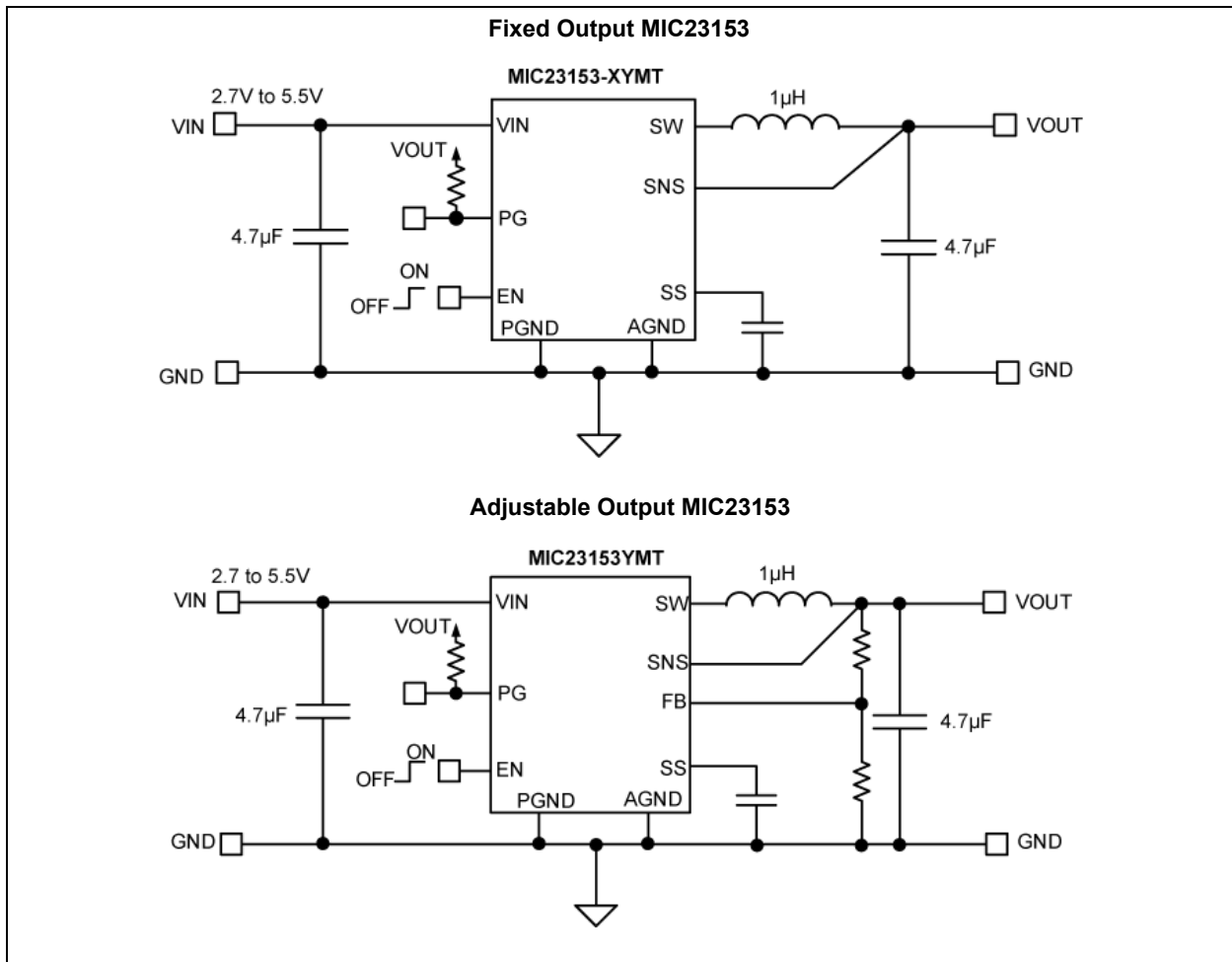

Functional Block Diagrams

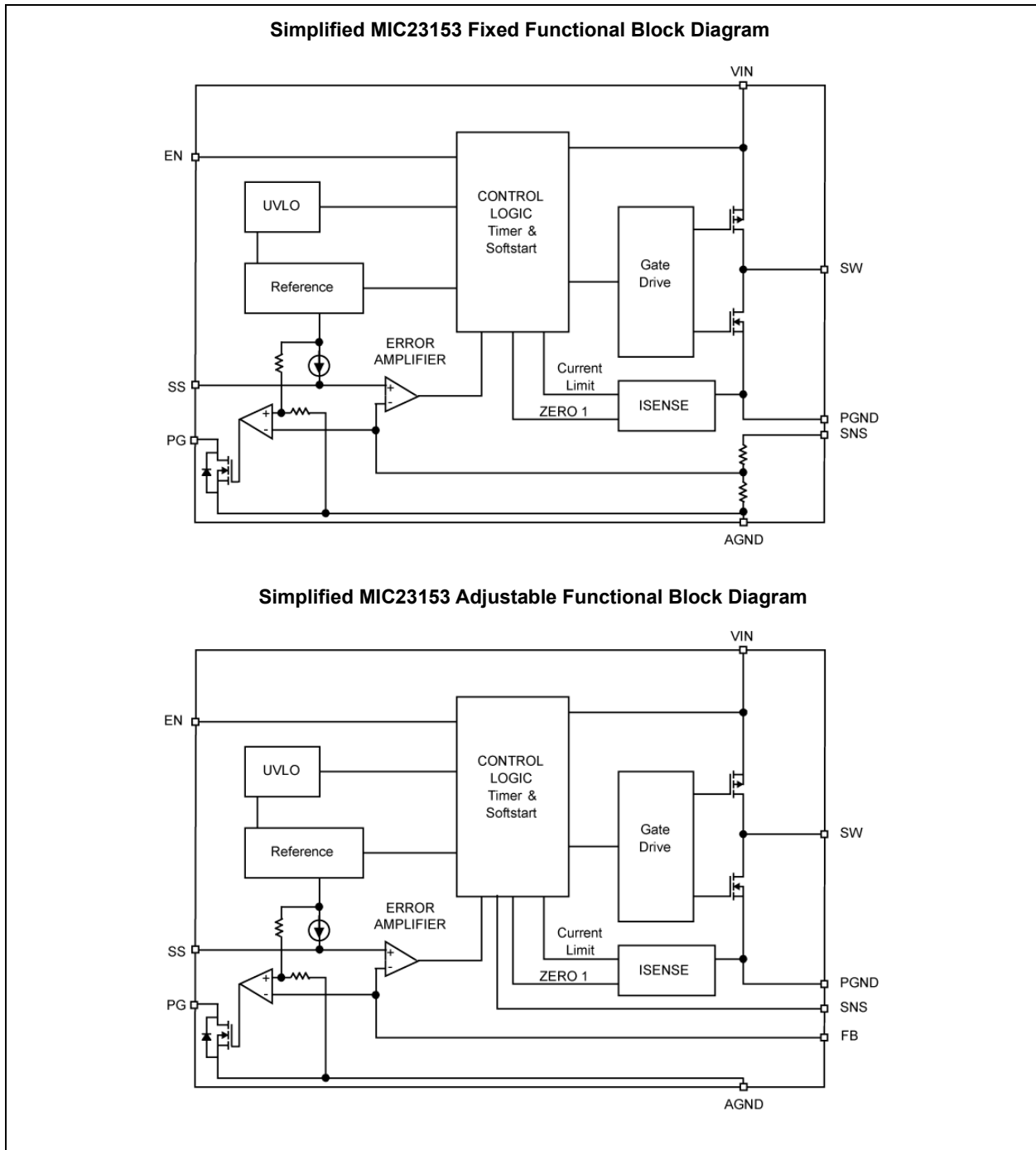

MIC23153

1.0 ELECTRICAL CHARACTERISTICS

Absolute Maximum Ratings †

Supply Voltage (V_{IN})	-0.3 to +6V
Sense Voltage (V_{SNS})	-0.3 to V_{IN}
Output Switch Voltage (V_{SW})	-0.3 to V_{IN}
Enable Input Voltage (V_{EN})	-0.3 to V_{IN}
Power Good (PG) Voltage (V_{PG})	-0.3 to V_{IN}
ESD Rating (Note 1)	ESD Sensitive

Operating Ratings ‡

Supply Voltage (V_{IN})	+2.7V to +5.5V
Enable Input Voltage (V_{EN})	0V to V_{IN}
Sense Voltage (V_{SNS})	0.62V to 3.6V

† **Notice:** Stresses above those listed under “Absolute Maximum Ratings” may cause permanent damage to the device. This is a stress rating only and functional operation of the device at those or any other conditions above those indicated in the operational sections of this specification is not intended. Exposure to maximum rating conditions for extended periods may affect device reliability. Specifications are for packaged product only.

‡ **Notice:** The device is not guaranteed to function outside its operating ratings.

Note 1: Devices are ESD sensitive. Handling precautions are recommended. Human body model, 1.5 k Ω in series with 100 pF.

ELECTRICAL CHARACTERISTICS

Electrical Characteristics: $T_A = 25^\circ\text{C}$, $V_{IN} = V_{EN} = 3.6\text{V}$; $L = 1\ \mu\text{H}$; $C_{OUT} = 4.7\ \mu\text{F}$; unless otherwise specified. **Bold** values indicate $-40^\circ\text{C} \leq T_J \leq +125^\circ\text{C}$. Specification for packaged product only.

Parameter	Symbol	Min.	Typ.	Max.	Units	Conditions
Supply Voltage Range	—	2.7	—	5.5	V	—
Undervoltage Lockout Threshold	V_{UVLO}	2.45	2.55	2.65	V	Turn-On
Undervoltage Lockout Hysteresis	—	—	75	—	mV	—
Quiescent Current	I_Q	—	22	45	μA	$I_{OUT} = 0\ \text{mA}$, $SNS > 1.2 \times V_{OUT(NOM)}$
Shutdown Current	I_{SHD}	—	0.01	5	μA	$V_{EN} = 0\text{V}$; $V_{IN} = 5.5\text{V}$
Output Voltage Accuracy	V_{OUT_ACC}	-2.5	—	+2.5	%	$V_{IN} = 3.6\text{V}$ if $V_{OUT(NOM)} < 2.5\text{V}$, $I_{LOAD} = 20\ \text{mA}$
						$V_{IN} = 4.5\text{V}$ if $V_{OUT(NOM)} \geq 2.5\text{V}$ $I_{LOAD} = 20\ \text{mA}$
Feedback Regulation Voltage	V_{REF}	0.6045	0.62	0.635	V	$I_{LOAD} = 20\ \text{mA}$
Current Limit	I_{LIM}	2.2	3.3	—	A	$SNS = 0.9 \times V_{OUT(NOM)}$
Output Voltage Line Regulation	—	—	0.3	—	%/ V	$V_{IN} = 3.6\text{V}$ to 5.5V if $V_{OUT(NOM)} < 2.5\text{V}$, $I_{LOAD} = 20\ \text{mA}$
				—		$V_{IN} = 4.5\text{V}$ to 5.5V if $V_{OUT(NOM)} \geq 2.5\text{V}$, $I_{LOAD} = 20\ \text{mA}$

ELECTRICAL CHARACTERISTICS (CONTINUED)

Electrical Characteristics: $T_A = 25^\circ\text{C}$, $V_{IN} = V_{EN} = 3.6\text{V}$; $L = 1\ \mu\text{H}$; $C_{OUT} = 4.7\ \mu\text{F}$; unless otherwise specified. **Bold** values indicate $-40^\circ\text{C} \leq T_J \leq +125^\circ\text{C}$. Specification for packaged product only.

Parameter	Symbol	Min.	Typ.	Max.	Units	Conditions
Output Voltage Load Regulation	—	—	0.3	—	%	20 mA < I_{LOAD} < 500 mA, $V_{IN} = 3.6\text{V}$ if $V_{OUT(NOM)} < 2.5\text{V}$
		—				20 mA < I_{LOAD} < 500 mA, $V_{IN} = 5.0\text{V}$ if $V_{OUT(NOM)} \geq 2.5\text{V}$
		—	0.7	—	%	20 mA < I_{LOAD} < 1A, $V_{IN} = 3.6\text{V}$ if $V_{OUT(NOM)} < 2.5\text{V}$
		—				20 mA < I_{LOAD} < 1A, $V_{IN} = 5.0\text{V}$ if $V_{OUT(NOM)} \geq 2.5\text{V}$
PWM Switch On-Resistance	$R_{DSON,P}$	—	0.2	—	Ω	$I_{SW} = 100\ \text{mA PMOS}$
	$R_{DSON,N}$	—	0.19	—		$I_{SW} = -100\ \text{mA NMOS}$
Switching Frequency	F_{SW}	—	4	—	MHz	$I_{OUT} = 120\ \text{mA}$
Soft-Start Time	—	—	320	—	μs	$V_{OUT} = 90\%$, $C_{SS} = 470\ \text{pF}$
Soft-Start Current	—	—	2.7	—	μA	$V_{SS} = 0\text{V}$
Power Good Threshold (Rising)	—	86	92	96	%	—
Power Good Threshold Hysteresis	—	—	7	—	%	—
Power Good Delay Time	—	—	68	—	μs	Rising
Enable Threshold	V_{EN}	0.5	0.9	1.2	V	Turn-On
Enable Input Current	—	—	0.1	2	μA	—
Overtemperature Shutdown	T_{SHD}	—	160	—	$^\circ\text{C}$	—
Overtemperature Shutdown Hysteresis	T_{SHD_HYST}	—	20	—	$^\circ\text{C}$	—

MIC23153

TEMPERATURE SPECIFICATIONS (Note 1)

Parameters	Sym.	Min.	Typ.	Max.	Units	Conditions
Temperature Ranges						
Junction Temperature Range	T_J	-40	—	+125	°C	—
Storage Temperature Range	T_S	-65	—	+150	°C	—
Lead Temperature	—	—	—	+260	°C	Soldering, 10 seconds
Package Thermal Resistances						
Thermal Resistance TDFN 2.5 mm x 2.5 mm	θ_{JA}	—	90	—	°C/W	—
Thermal Resistance TDFN 2.5 mm x 2.5 mm	θ_{JC}	—	63	—	°C/W	—

Note 1: The maximum allowable power dissipation is a function of ambient temperature, the maximum allowable junction temperature and the thermal resistance from junction to air (i.e., T_A , T_J , θ_{JA}). Exceeding the maximum allowable power dissipation will cause the device operating junction temperature to exceed the maximum +125°C rating. Sustained junction temperatures above +125°C can impact the device reliability.

2.0 TYPICAL PERFORMANCE CURVES

Note: The graphs and tables provided following this note are a statistical summary based on a limited number of samples and are provided for informational purposes only. The performance characteristics listed herein are not tested or guaranteed. In some graphs or tables, the data presented may be outside the specified operating range (e.g., outside specified power supply range) and therefore outside the warranted range.

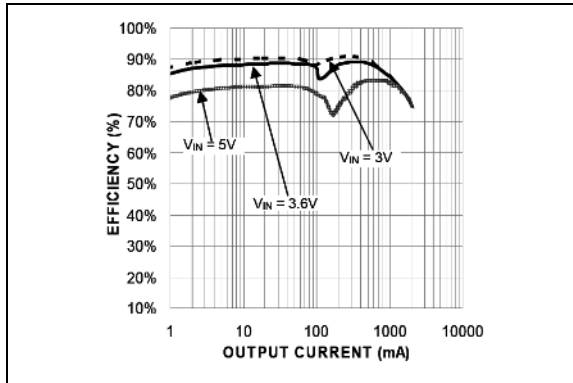

FIGURE 2-1: Efficiency vs. Output Current ($V_{OUT} = 1.8V @ 25^{\circ}C$).

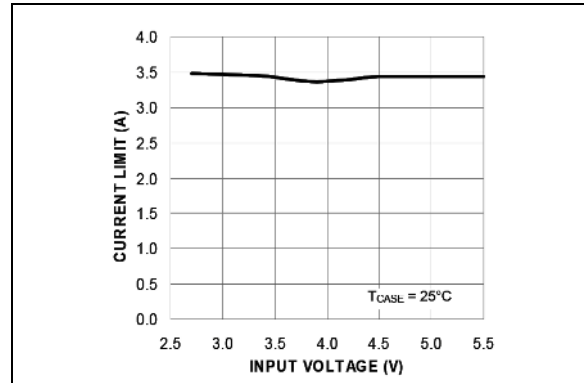

FIGURE 2-4: Current Limit vs Input Voltage.

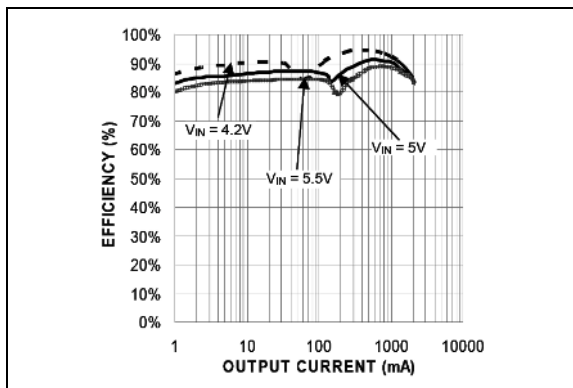

FIGURE 2-2: Efficiency vs. Output Current ($V_{OUT} = 3.3V @ 25^{\circ}C$).

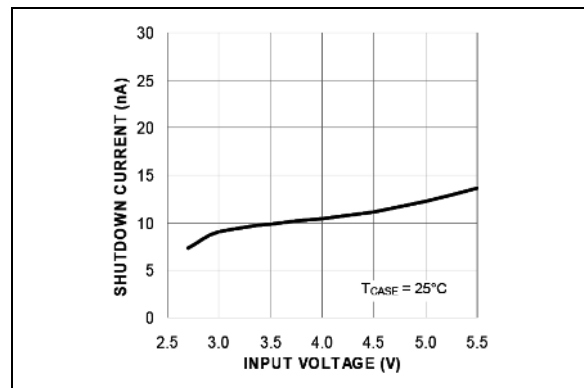

FIGURE 2-5: Shutdown Current vs Input Voltage.

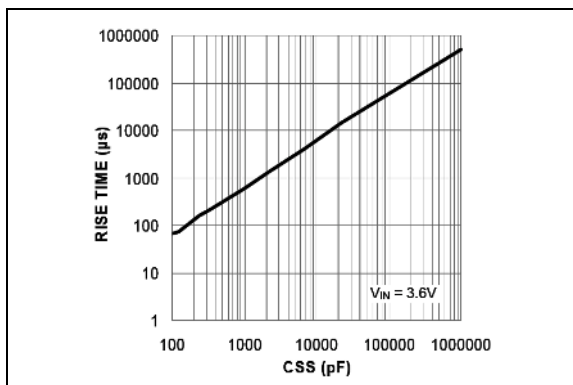

FIGURE 2-3: V_{OUT} Rise Time vs. C_{SS} .

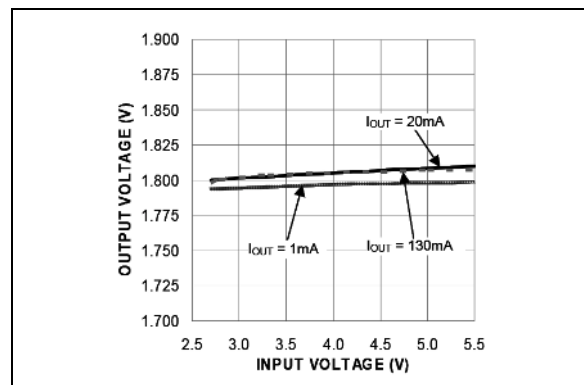

FIGURE 2-6: Line Regulation (Low Loads).

MIC23153

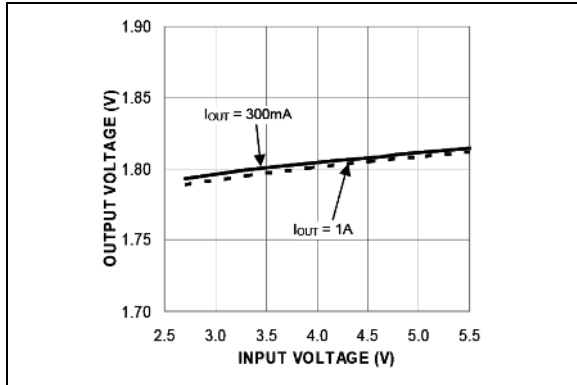

FIGURE 2-7: Line Regulation (High Loads).

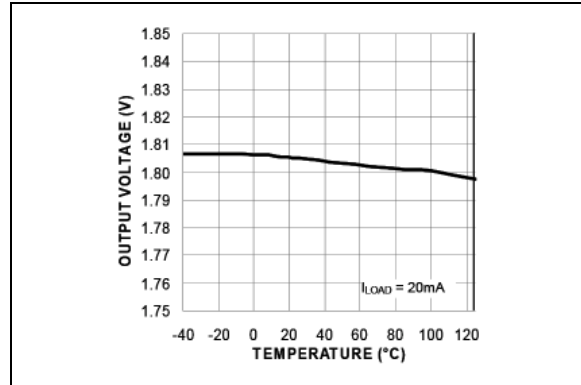

FIGURE 2-10: Output Voltage vs. Temperature.

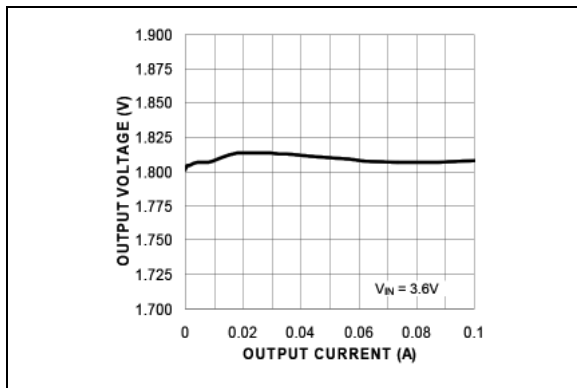

FIGURE 2-8: Output Voltage vs. Output Current (HLL).

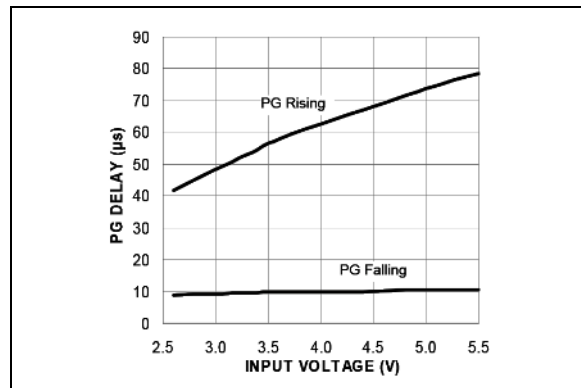

FIGURE 2-11: Power Good Delay Time vs. Input Voltage.

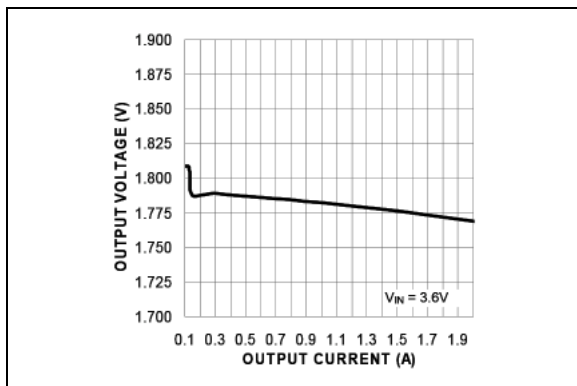

FIGURE 2-9: Output Voltage vs. Output Current (CCM).

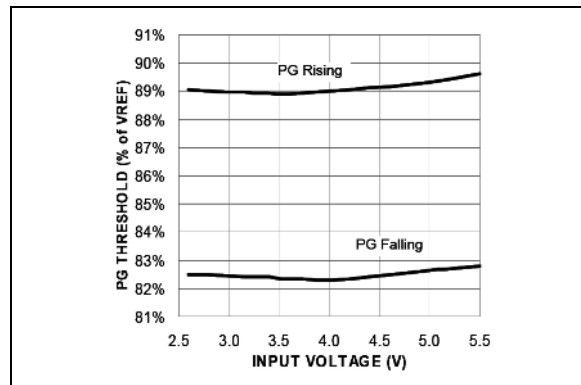

FIGURE 2-12: Power Good Thresholds vs. Input Voltage.

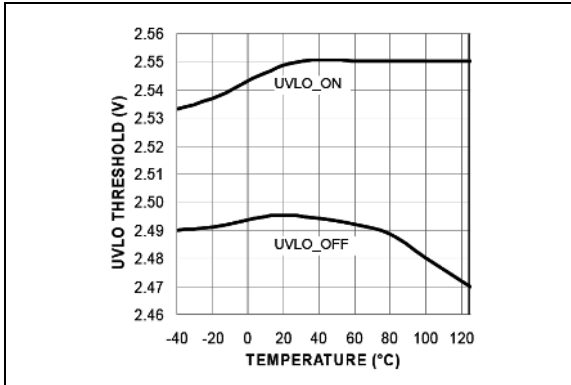

FIGURE 2-13: UVLO Threshold vs. Temperature.

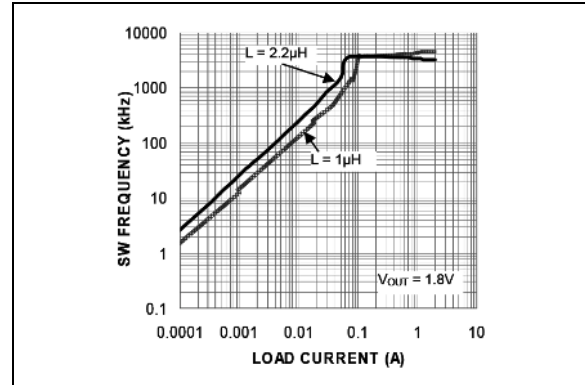

FIGURE 2-16: Switching Frequency vs. Load Current.

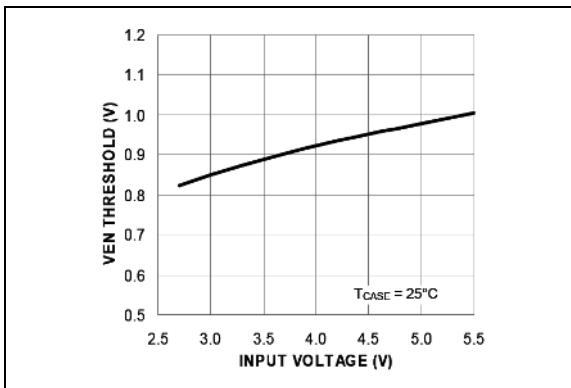

FIGURE 2-14: Enable Threshold vs. Input Voltage.

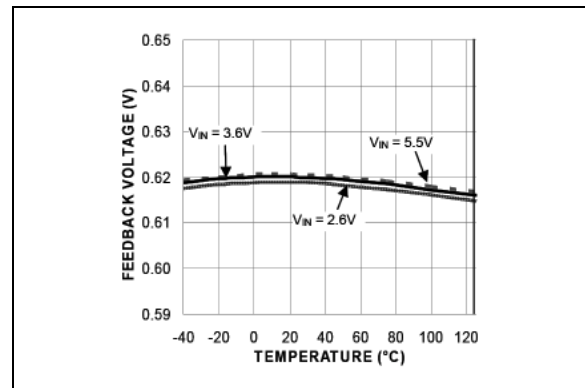

FIGURE 2-17: Feedback Voltage vs. Temperature.

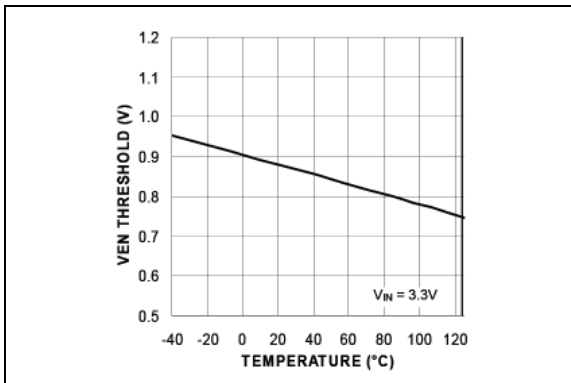

FIGURE 2-15: Enable Threshold vs. Temperature.

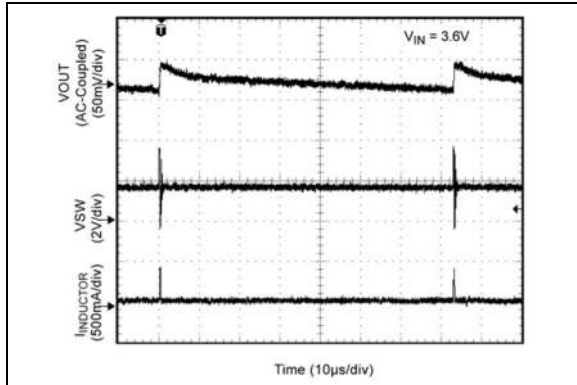

FIGURE 2-18: Switching Waveform Discontinuous Mode (Load = 1 mA).

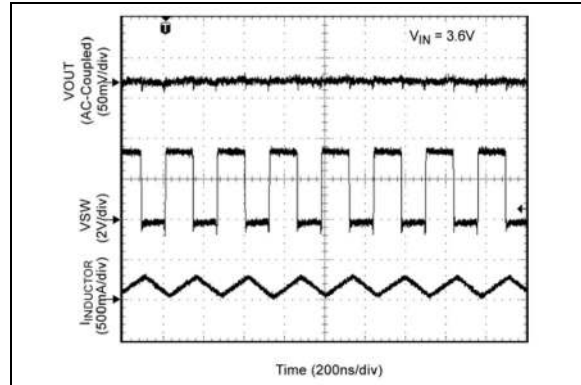

FIGURE 2-21: Switching Waveform Continuous Mode (Load = 150 mA).

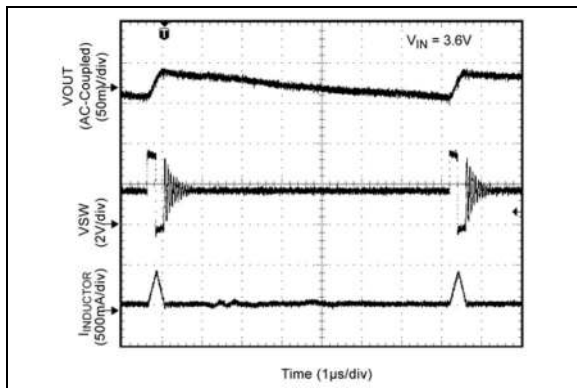

FIGURE 2-19: Switching Waveform Discontinuous Mode (Load = 10 mA).

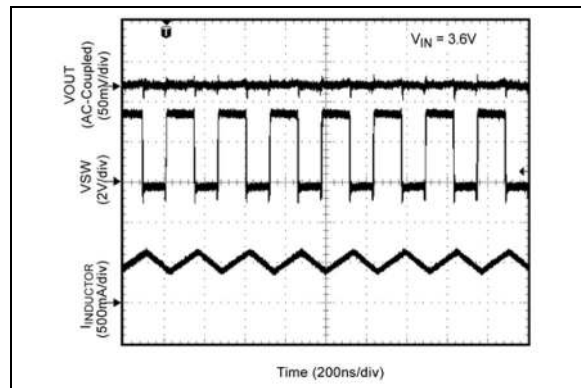

FIGURE 2-22: Switching Waveform Continuous Mode (Load = 500 mA).

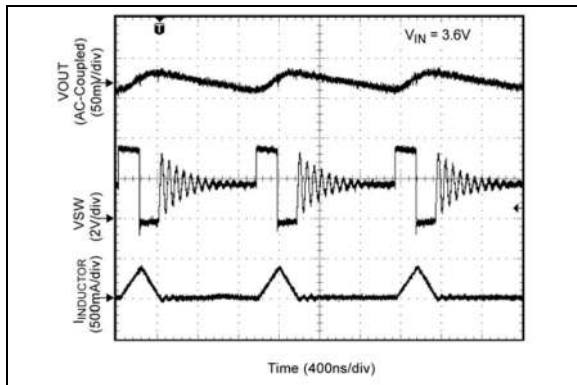

FIGURE 2-20: Switching Waveform Discontinuous Mode (Load = 50 mA).

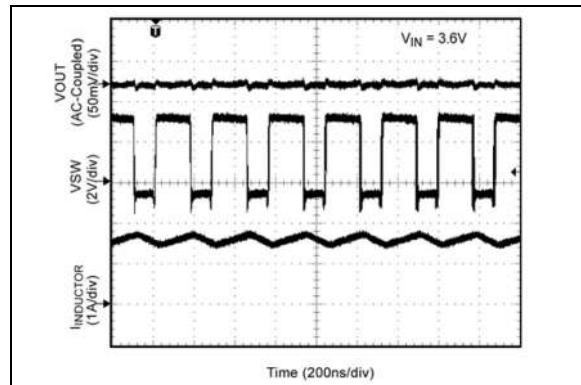

FIGURE 2-23: Switching Waveform Continuous Mode (Load = 1.5A).

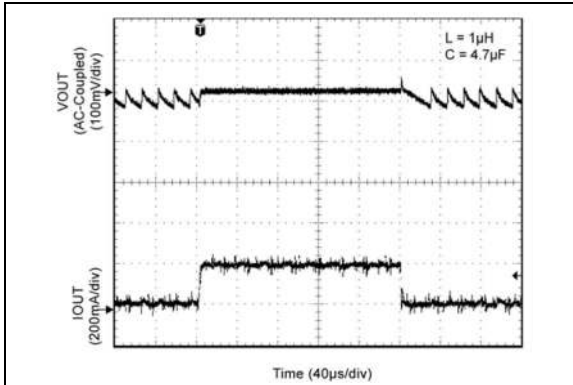

FIGURE 2-24: Load Transient (10 mA to 200 mA).

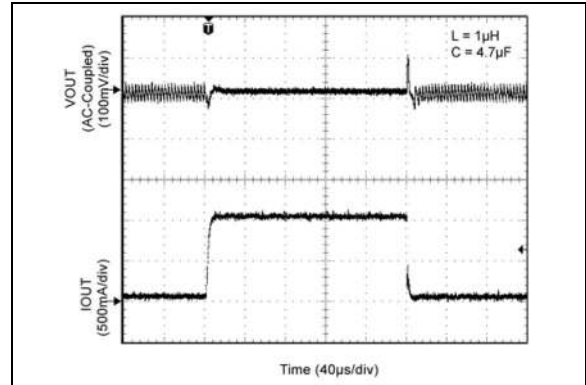

FIGURE 2-27: Load Transient (50 mA to 1A).

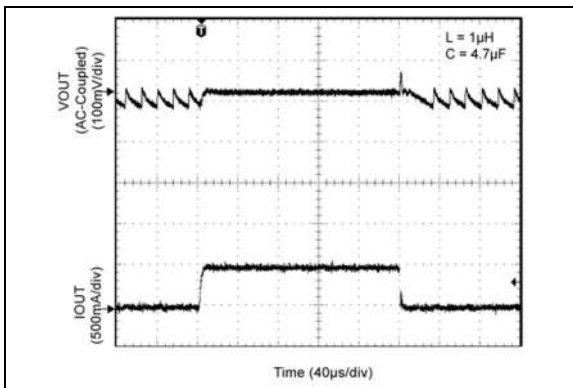

FIGURE 2-25: Load Transient (10 mA to 500 mA).

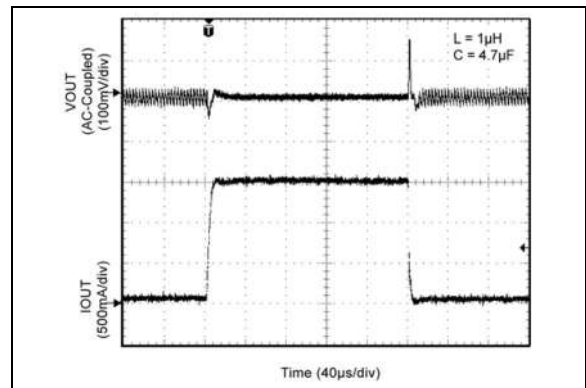

FIGURE 2-28: Load Transient (50 mA to 1.5A).

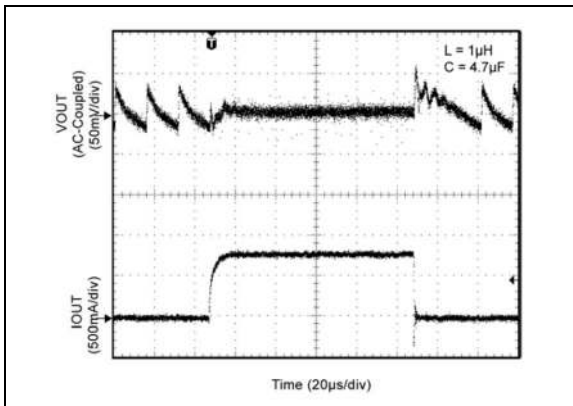

FIGURE 2-26: Load Transient (10 mA to 750 mA).

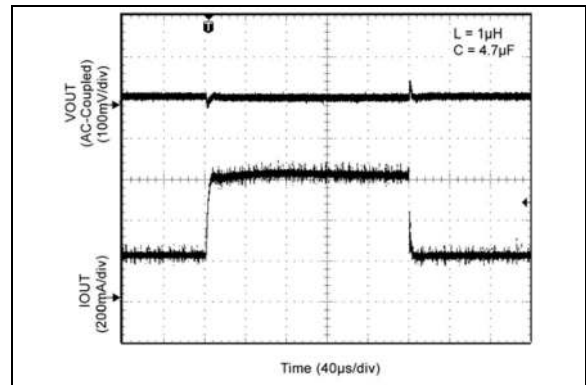

FIGURE 2-29: Load Transient (200 mA to 600 mA).

MIC23153

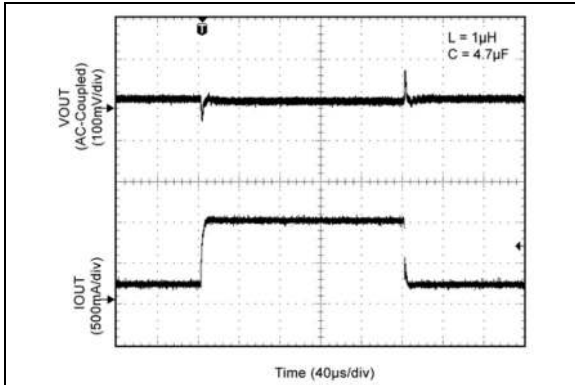

FIGURE 2-30: Load Transient (200 mA to 1A).

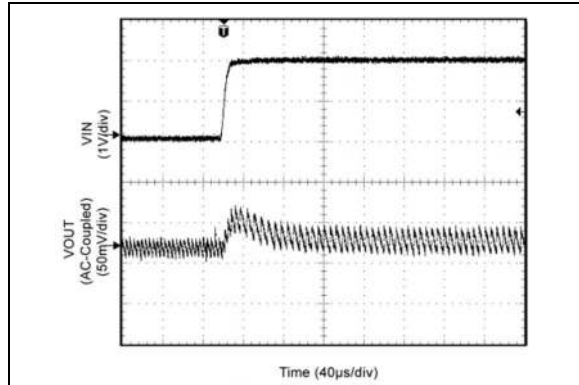

FIGURE 2-33: Line Transient (3.6V to 5.5V @ 20 mA Load).

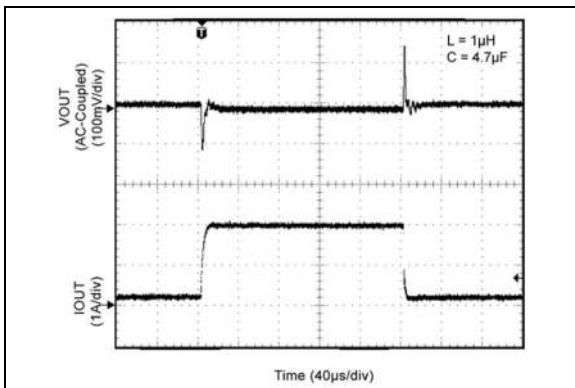

FIGURE 2-31: Load Transient (200 mA to 2A).

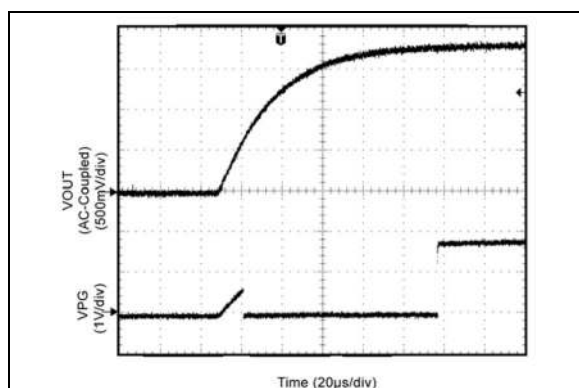

FIGURE 2-34: Start-Up and Power Good Waveform.

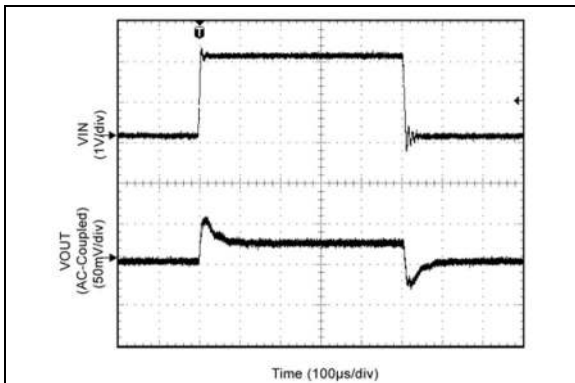

FIGURE 2-32: Line Transient (3.6V to 5.5V @ 1.5A Load).

3.0 PIN DESCRIPTIONS

The descriptions of the pins are listed in [Table 3-1](#).

TABLE 3-1: PIN FUNCTION TABLE

Pin Number (Fixed)	Pin Number (Adjustable)	Pin Name	Description
1	1	SW	Switch (Output): Internal power MOSFET output switches.
2	2	EN	Enable (Input): Logic high enables operation of the regulator. Logic low will shut down the device. Do not leave floating.
3	3	SNS	Sense: Connect to V_{OUT} as close to output capacitor as possible to sense output voltage.
4	—	NC	Not Internally Connected.
—	4	FB	Feedback: Connect a resistor divider from the output to ground to set the output voltage.
5	5	PG	Power Good: Open-drain output for the power good indicator. Use a pull-up resistor from this pin to a voltage source to detect a power good condition.
6	6	SS	Soft-Start: Place a capacitor from this pin to ground to program the soft start time. Do not leave floating, 100 pF minimum C_{SS} is required.
7	7	AGND	Analog Ground: Connect to central ground point where all high current paths meet (C_{IN} , C_{OUT} , PGND) for best operation.
8, 9	8, 9	VIN	Input Voltage: Connect a capacitor to ground to decouple the noise.
10	10	PGND	Power Ground.

MIC23153

4.0 FUNCTIONAL DESCRIPTION

4.1 VIN

The input supply (VIN) provides power to the internal MOSFETs for the switch mode regulator along with the internal control circuitry. The VIN operating range is 2.7V to 5.5V so an input capacitor, with a minimum voltage rating of 6.3V, is recommended. Due to the high switching speed, a minimum 2.2 μ F bypass capacitor placed close to VIN and the power ground (PGND) pin is required.

4.2 EN

A logic high signal on the enable pin activates the output voltage of the device. A logic low signal on the enable pin deactivates the output and reduces supply current to 0.01 μ A. MIC23153 features external soft start circuitry via the soft-start (SS) pin that reduces inrush current and prevents the output voltage from overshooting at start up. Do not leave the EN pin floating.

4.3 SW

The switch (SW) connects directly to one end of the inductor and provides the current path during switching cycles. The other end of the inductor is connected to the load, SNS pin and output capacitor. Due to the high speed switching on this pin, the switch node should be routed away from sensitive nodes whenever possible.

4.4 SNS

The sense (SNS) pin is connected to the output of the device to provide feedback to the control circuitry. The SNS connection should be placed close to the output capacitor.

4.5 AGND

The analog ground (AGND) is the ground path for the biasing and control circuitry. The current loop for the signal ground should be separate from the power ground (PGND) loop.

4.6 PGND

The power ground pin is the ground path for the high current in PWM mode. The current loop for the power ground should be as small as possible and separate from the analog ground (AGND) loop as applicable.

4.7 Power Good (PG)

The Power Good (PG) pin is an open drain output which indicates logic high when the output voltage is typically above 92% of its steady state voltage. A pull up resistor of more than 5 k Ω should be connected from PG to V_{OUT}.

4.8 Soft-Start

The soft-start (SS) pin is used to control the output voltage ramp up time. The approximate equation for the ramp time in milliseconds is:

EQUATION 4-1:

$$t(ms) = 270 \times 10^3 \times In(10) \times C_{SS}$$

Where:

t = The time in milliseconds

C_{SS} = External soft-start capacitance (in Farads)

For example, for a C_{SS} = 470 pF, t_{RISE} ~ 0.3 ms or 300 μ s. See [Section 2.0, Typical Performance Curves](#) for a graphical guide. The minimum recommended value for C_{SS} is 100 pF.

4.9 FB

The feedback (FB) pin is provided for the adjustable voltage option (no internal connection for fixed options). This is the control input for programming the output voltage. A resistor divider network is connected to this pin from the output and is compared to the internal 0.62V reference within the regulation loop.

The output voltage can be programmed between 0.65V and 3.6V using the following equation:

EQUATION 4-2:

$$V_{OUT} = V_{REF} \left(1 + \frac{R1}{R2} \right)$$

Where:

R1 = Top resistor

R2 = Bottom resistor

Example feedback resistor values:

TABLE 4-1: FEEDBACK RESISTOR VALUES

V _{OUT}	R1	R2
1.2V	274 k Ω	294 k Ω
1.5V	316 k Ω	221 k Ω
1.8V	301 k Ω	158 k Ω
2.5V	324 k Ω	107 k Ω
3.3V	309 k Ω	71.5 k Ω

5.0 APPLICATIONS INFORMATION

The MIC23153 is a high performance DC-to-DC step-down regulator offering a small solution size. Supporting an output current up to 2A inside a tiny 2.5 mm x 2.5 mm TDFN package, the IC requires only three external components while meeting today's miniature portable electronic device needs. Using the HyperLight Load[®] switching scheme, the MIC23153 is able to maintain high efficiency throughout the entire load range while providing ultra-fast load transient response. The following sections provide additional device application information.

5.1 Input Capacitor

A 2.2 μF ceramic capacitor or greater should be placed close to the VIN pin and PGND pin for bypassing. A Murata GRM188R60J475ME84D, size 0603, 4.7 μF ceramic capacitor is recommended based upon performance, size, and cost. A X5R or X7R temperature rating is recommended for the input capacitor. Y5V temperature rating capacitors, aside from losing most of their capacitance over temperature, can also become resistive at high frequencies. This reduces their ability to filter out high frequency noise.

5.2 Output Capacitor

The MIC23153 is designed for use with a 2.2 μF or greater ceramic output capacitor. Increasing the output capacitance will lower output ripple and improve load transient response but could also increase solution size or cost. A low equivalent series resistance (ESR) ceramic output capacitor such as the Samsung CL10B475KQ8NQNC, size 0603, 4.7 μF ceramic capacitor is recommended based upon performance, size, and cost. Both the X7R or X5R temperature rating capacitors are recommended. The Y5V and Z5U temperature rating capacitors are not recommended due to their wide variation in capacitance over temperature and increased resistance at high frequencies.

5.3 Inductor Selection

When selecting an inductor, it is important to consider the following factors (not necessarily in the order of importance):

- Inductance
- Rated current value
- Size requirements
- DC resistance (DCR)

The MIC23153 is designed for use with a 0.47 μH to 2.2 μH inductor. For faster transient response, a 0.47 μH inductor will yield the best result. For lower output ripple, a 2.2 μH inductor is recommended.

Maximum current ratings of the inductor are generally given in two methods; permissible DC current and saturation current. Permissible DC current can be rated either for a 40°C temperature rise or a 10% to 20% loss in inductance. Ensure the inductor selected can handle the maximum operating current. When saturation current is specified, make sure that there is enough margin so that the peak current does not cause the inductor to saturate. Peak current can be calculated as follows:

EQUATION 5-1:

$$I_{PEAK} = \left[I_{OUT} + V_{OUT} \left(\frac{1 - V_{OUT}/V_{IN}}{2 \times f \times L} \right) \right]$$

As shown by the calculation above, the peak inductor current is inversely proportional to the switching frequency and the inductance; the lower the switching frequency or the inductance the higher the peak current. As input voltage increases, the peak current also increases.

DC resistance (DCR) is also important. While DCR is inversely proportional to size, DCR can represent a significant efficiency loss. Refer to the [Section 5.6 "Efficiency Considerations"](#).

The transition between high loads (CCM) to HyperLight Load[®] (HLL) mode is determined by the inductor ripple current and the load current.

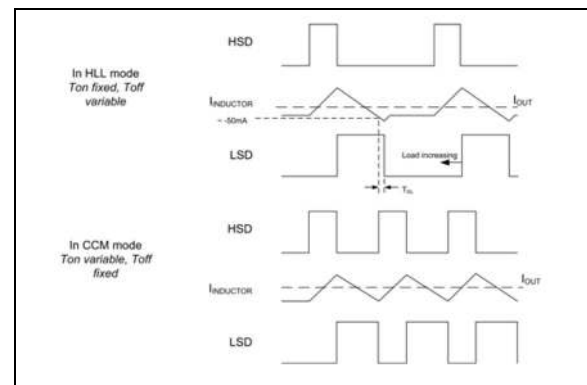

FIGURE 5-1: Control Signals.

The diagram shows the signals for high side switch drive (HSD) for t_{ON} control, the inductor current and the low side switch drive (LSD) for t_{OFF} control.

In HLL mode, the inductor is charged with a fixed Ton pulse on the high side switch (HSD). After this, the LSD is switched on and current falls at a rate V_{OUT}/L . The controller remains in HLL mode while the inductor falling current is detected to cross approximately -50 mA . When the LSD (or t_{OFF}) time reaches its

MIC23153

minimum and the inductor falling current is no longer able to reach this –50 mA threshold, the part is in CCM mode and switching at a virtually constant frequency.

Once in CCM mode, the t_{OFF} time will not vary. Therefore, it is important to note that if L is large enough, the HLL transition level will not be triggered.

That inductor is:

EQUATION 5-2:

$$L_{MAX} = \frac{V_{OUT} \times 135ns}{2 \times 50mA}$$

5.4 Compensation

The MIC23153 is designed to be stable with a 0.47 μ H to 2.2 μ H inductor with a 4.7 μ F ceramic (X5R) output capacitor.

5.5 Duty Cycle

The typical maximum duty cycle of the MIC23153 is 80%.

5.6 Efficiency Considerations

Efficiency is defined as the amount of useful output power, divided by the amount of power supplied.

EQUATION 5-3:

$$\eta = \left(\frac{V_{OUT} \times I_{OUT}}{V_{IN} \times I_{IN}} \right) \times 100$$

Maintaining high efficiency serves two purposes. It reduces power dissipation in the power supply, reducing the need for heat sinks and thermal design considerations and it reduces consumption of current for battery powered applications. Reduced current draw from a battery increases the devices operating time which is critical in hand held devices.

There are two types of losses in switching converters; DC losses and switching losses. DC losses are simply the power dissipation of I^2R . Power is dissipated in the high-side switch during the on cycle. Power loss is equal to the high-side MOSFET $R_{DS(ON)}$ multiplied by the switch current squared. During the off cycle, the low-side N-channel MOSFET conducts, also dissipating power. Device operating current also reduces efficiency. The product of the quiescent (operating) current and the supply voltage represents

another DC loss. The current required driving the gates on and off at a constant 4 MHz frequency and the switching transitions make up the switching losses.

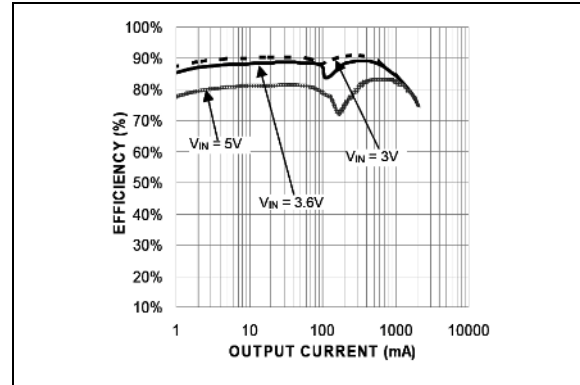

FIGURE 5-2: Efficiency Under Load
 $V_{OUT} = 1.8V @ 25^{\circ}C$.

Figure 5-2 shows an efficiency curve. From no load to 100 mA, efficiency losses are dominated by quiescent current losses, gate drive and transition losses. By using the HyperLight Load[®] mode, the MIC23153 is able to maintain high efficiency at low output currents.

Over 100 mA, efficiency loss is dominated by MOSFET $R_{DS(ON)}$ and inductor losses. Higher input supply voltages will increase the gate to source threshold on the internal MOSFETs, thereby reducing the internal $R_{DS(ON)}$. This improves efficiency by reducing DC losses in the device. All but the inductor losses are inherent to the device. In which case, inductor selection becomes increasingly critical in efficiency calculations. As the inductors are reduced in size, the DC resistance (DCR) can become quite significant.

The DCR losses can be calculated by using [Equation 5-4](#):

EQUATION 5-4:

$$P_{DCR} = I_{OUT}^2 \times DCR$$

From that, the loss in efficiency due to inductor resistance can be calculated by using [Equation 5-5](#):

EQUATION 5-5:

$$EfficiencyLoss = \left[1 - \left(\frac{V_{OUT} \times I_{OUT}}{V_{OUT} \times I_{OUT} + P_{DCR}} \right) \right] \times 100$$

Efficiency loss due to DCR is minimal at light loads and gains significance as the load is increased. Inductor selection becomes a trade-off between efficiency and size in this case.

5.7 HyperLight Load[®] Mode

The MIC23153 uses a minimum on and off time proprietary control loop. When the output voltage falls below the regulation threshold, the error comparator begins a switching cycle that turns the PMOS on and keeps it on for the duration of the minimum on-time. When the output voltage is over the regulation threshold, the error comparator turns the PMOS off for a minimum off-time. The NMOS acts as an ideal rectifier that conducts when the PMOS is off. Using a NMOS switch instead of a diode allows for lower voltage drop across the switching device when it is on. The asynchronous switching combination between the PMOS and the NMOS allows the control loop to work in discontinuous mode for light load operations. In discontinuous mode, MIC23153 works in pulse frequency modulation (PFM) to regulate the output. As the output current increases, the switching frequency increases. This improves the efficiency of the MIC23153 during light load currents. As the load current increases, the MIC23153 goes into continuous conduction mode (CCM) at a constant frequency of 4 MHz. The equation to calculate the load when the MIC23153 goes into continuous conduction mode may be approximated by the following [Equation 5-6](#):

EQUATION 5-6:

$$I_{LOAD} = \left(\frac{(V_{IN} - V_{OUT}) \times D}{2 \times L \times f} \right)$$

As shown in the above equation, the load at which MIC23153 transitions from HyperLight Load[®] mode to PWM mode is a function of the input voltage (V_{IN}), output voltage (V_{OUT}), duty cycle (D), inductance (L) and frequency (f). As shown in [Figure 5-3](#), as the output current increases, the switching frequency also increases until the MIC23153 goes from HyperLight Load[®] mode to PWM mode at approximately 120 mA. The MIC23153 will switch at a relatively constant frequency around 4 MHz once the output current is over 120 mA.

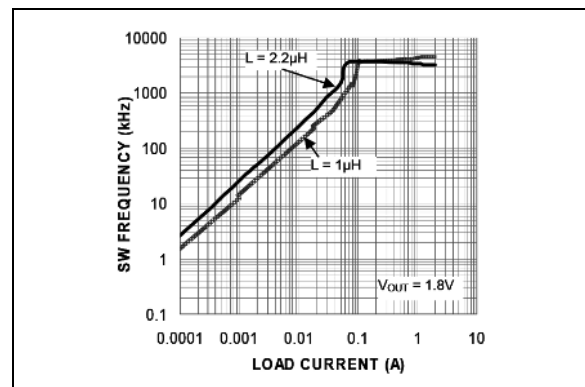

FIGURE 5-3: Switching Frequency vs. Output Current.

MIC23153

6.0 PACKAGING INFORMATION

6.1 Package Marking Information

10-Lead TDFN*

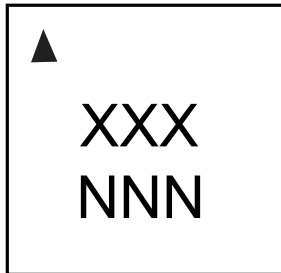

Example

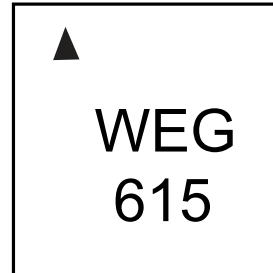

Part Number	Code
MIC23153-GYMT-TR	WEG
MIC23153YMT-TR	WEA

Note: The content of this table applies to 10-Lead TDFN.

Legend:	XX...X	Product code or customer-specific information
	Y	Year code (last digit of calendar year)
	YY	Year code (last 2 digits of calendar year)
	WW	Week code (week of January 1 is week '01')
	NNN	Alphanumeric traceability code
	(e3)	Pb-free JEDEC® designator for Matte Tin (Sn)
	*	This package is Pb-free. The Pb-free JEDEC designator (e3) can be found on the outer packaging for this package.
	•, ▲, ▼	Pin one index is identified by a dot, delta up, or delta down (triangle mark).
Note:	In the event the full Microchip part number cannot be marked on one line, it will be carried over to the next line, thus limiting the number of available characters for customer-specific information. Package may or may not include the corporate logo.	
	Underbar (¯) and/or Overbar (˘) symbol may not be to scale.	

Note: If the full seven-character YYWWNNN code cannot fit on the package, the following truncated codes are used based on the available marking space:
6 Characters = YWWNNN; 5 Characters = WWNNN; 4 Characters = WNNN; 3 Characters = NNN;
2 Characters = NN; 1 Character = N

10-Lead TDFN 2.5 mm x 2.5 mm Package Outline and Recommended Land Pattern

TITLE

10 LEAD TDFN 2.5x2.5mm PACKAGE OUTLINE & RECOMMENDED LAND PATTERN

DRAWING #	TDFN2525-10LD-PL-1	UNIT	MM
Lead Frame	Copper	Lead Finish	Matte Tin

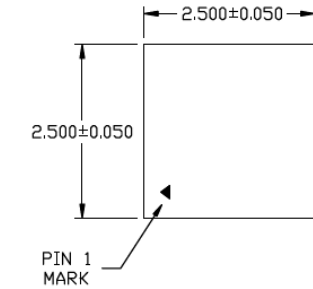

TOP VIEW
NOTE: 1, 2, 3

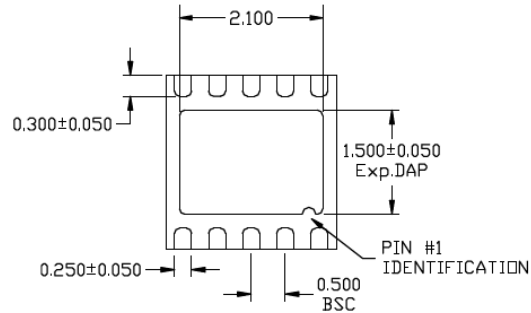

BOTTOM VIEW
NOTE: 1, 2

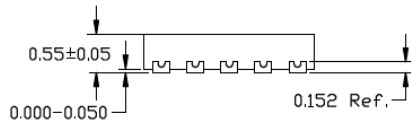

SIDE VIEW
NOTE: 1, 2

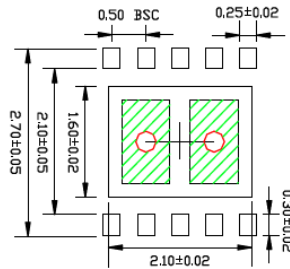

RECOMMENDED LAND PATTERN
NOTE: 4

NOTE:

1. MAX PACKAGE WARPAGE IS 0.05MM
2. MAX ALLOWABLE BURR IS 0.076MM IN ALL DIRECTIONS
3. PIN #1 IS ON TOP WILL BE LASER MARKED
4. GREEN RECTANGLES (SHADED AREA) INDICATE STENCIL OPENING ON EXPOSED AREA. SIZE IS 0.6X0.9MM, SPACING IS 0.3MM.
5. RED CIRCLES REPRESENT THERMAL VIAS & SHOULD BE CONNECTED TO GND FOR MAX PERFORMANCE. 0.30 - 0.35 MM RECOMMENDED DIAMETER, 1.00 MM PITCH

Note: For the most current package drawings, please see the Microchip Packaging Specification located at <http://www.microchip.com/packaging>.

MIC23153

NOTES:

APPENDIX A: REVISION HISTORY

Revision A (February 2021)

- Converted Micrel document MIC23153 to Microchip data sheet DS20006489B.
- Minor text changes throughout.

Revision B (April 2022)

- Updated **Section “Product Identification System”**.
- Updated **Section 6.0 “Packaging Information”**.
- Corrected package outline image to **“10-Lead TDFN 2.5 mm x 2.5 mm Package Outline and Recommended Land Pattern”** from a 10-Lead TDFN image.
- Minor format changes throughout.

MIC23153

NOTES:

PRODUCT IDENTIFICATION SYSTEM

To order or obtain information, e.g., on pricing or delivery, contact your local Microchip representative or sales office.

<u>PART NO.</u>	<u>-X</u>	<u>X</u>	<u>XX</u>	<u>-XX</u>
Device	Output Voltage	Junction Temperature Range	Package Option	Media Type
Device:	MIC23153: 4 MHz 2A PWM Buck Regulator with HyperLight Load® and Power Good			
Output Voltage:	G = 1.8V Blank = Adjustable			
Junction Temperature Range:		Y = -40°C to +125°C		
Package:			MT = 10-Lead 2.5 mm x 2.5 mm x 0.6 mm TDFN	
Media Type:				TR = 5000/Reel
Note: Other output voltage options are available. Contact Factory for details.				

Examples:

- a) MIC23153-GYMT-TR: 4 MHz 2A PWM Buck Regulator with HyperLight Load® and Power Good, 1.8V Fixed Output Voltage, -40°C to +125°C Junction Temperature Range, Pb-Free, RoHS Compliant, 10-Lead TDFN Package, 5000/Reel
- b) MIC23153YMT-TR: 4 MHz 2A PWM Buck Regulator with HyperLight Load® and Power Good, Adjustable Output Voltage, -40°C to +125°C Junction Temperature Range, Pb-Free, RoHS Compliant, 10-Lead TDFN Package, 5000/Reel

Note 1: Tape and Reel identifier only appears in the catalog part number description. This identifier is used for ordering purposes and is not printed on the device package. Check with your Microchip Sales Office for package availability with the Tape and Reel option.

MIC23153

NOTES:

Note the following details of the code protection feature on Microchip products:

- Microchip products meet the specifications contained in their particular Microchip Data Sheet.
- Microchip believes that its family of products is secure when used in the intended manner, within operating specifications, and under normal conditions.
- Microchip values and aggressively protects its intellectual property rights. Attempts to breach the code protection features of Microchip product is strictly prohibited and may violate the Digital Millennium Copyright Act.
- Neither Microchip nor any other semiconductor manufacturer can guarantee the security of its code. Code protection does not mean that we are guaranteeing the product is “unbreakable”. Code protection is constantly evolving. Microchip is committed to continuously improving the code protection features of our products.

This publication and the information herein may be used only with Microchip products, including to design, test, and integrate Microchip products with your application. Use of this information in any other manner violates these terms. Information regarding device applications is provided only for your convenience and may be superseded by updates. It is your responsibility to ensure that your application meets with your specifications. Contact your local Microchip sales office for additional support or, obtain additional support at <https://www.microchip.com/en-us/support/design-help/client-support-services>.

THIS INFORMATION IS PROVIDED BY MICROCHIP "AS IS". MICROCHIP MAKES NO REPRESENTATIONS OR WARRANTIES OF ANY KIND WHETHER EXPRESS OR IMPLIED, WRITTEN OR ORAL, STATUTORY OR OTHERWISE, RELATED TO THE INFORMATION INCLUDING BUT NOT LIMITED TO ANY IMPLIED WARRANTIES OF NON-INFRINGEMENT, MERCHANTABILITY, AND FITNESS FOR A PARTICULAR PURPOSE, OR WARRANTIES RELATED TO ITS CONDITION, QUALITY, OR PERFORMANCE.

IN NO EVENT WILL MICROCHIP BE LIABLE FOR ANY INDIRECT, SPECIAL, PUNITIVE, INCIDENTAL, OR CONSEQUENTIAL LOSS, DAMAGE, COST, OR EXPENSE OF ANY KIND WHATSOEVER RELATED TO THE INFORMATION OR ITS USE, HOWEVER CAUSED, EVEN IF MICROCHIP HAS BEEN ADVISED OF THE POSSIBILITY OR THE DAMAGES ARE FORESEEABLE. TO THE FULLEST EXTENT ALLOWED BY LAW, MICROCHIP'S TOTAL LIABILITY ON ALL CLAIMS IN ANY WAY RELATED TO THE INFORMATION OR ITS USE WILL NOT EXCEED THE AMOUNT OF FEES, IF ANY, THAT YOU HAVE PAID DIRECTLY TO MICROCHIP FOR THE INFORMATION.

Use of Microchip devices in life support and/or safety applications is entirely at the buyer's risk, and the buyer agrees to defend, indemnify and hold harmless Microchip from any and all damages, claims, suits, or expenses resulting from such use. No licenses are conveyed, implicitly or otherwise, under any Microchip intellectual property rights unless otherwise stated.

For information regarding Microchip's Quality Management Systems, please visit www.microchip.com/quality.

Trademarks

The Microchip name and logo, the Microchip logo, Adaptec, AnyRate, AVR, AVR logo, AVR Freaks, BesTime, BitCloud, CryptoMemory, CryptoRF, dsPIC, flexPWR, HELDO, IGLOO, JukeBlox, KeeLoq, Klear, LANCheck, LinkMD, maXStylus, maXTouch, MediaLB, megaAVR, Microsemi, Microsemi logo, MOST, MOST logo, MPLAB, OptoLyzzer, PIC, picoPower, PICSTART, PIC32 logo, PolarFire, Prochip Designer, QTouch, SAM-BA, SenGenuity, SpyNIC, SST, SST Logo, SuperFlash, Symmetricom, SyncServer, Tachyon, TimeSource, tinyAVR, UNI/O, Vectron, and XMEGA are registered trademarks of Microchip Technology Incorporated in the U.S.A. and other countries.

AgileSwitch, APT, ClockWorks, The Embedded Control Solutions Company, EtherSynch, Flashtec, Hyper Speed Control, HyperLight Load, IntelliMOS, Libero, motorBench, mTouch, Powermite 3, Precision Edge, ProASIC, ProASIC Plus, ProASIC Plus logo, QuietWire, SmartFusion, SyncWorld, Temux, TimeCesium, TimeHub, TimePictra, TimeProvider, TrueTime, WinPath, and ZL are registered trademarks of Microchip Technology Incorporated in the U.S.A.

Adjacent Key Suppression, AKS, Analog-for-the-Digital Age, Any Capacitor, AnyIn, AnyOut, Augmented Switching, BlueSky, BodyCom, CodeGuard, CryptoAuthentication, CryptoAutomotive, CryptoCompanion, CryptoController, dsPICDEM, dsPICDEM.net, Dynamic Average Matching, DAM, ECAN, Espresso T1S, EtherGREEN, GridTime, IdealBridge, In-Circuit Serial Programming, ICSP, INICnet, Intelligent Paralleling, Inter-Chip Connectivity, JitterBlocker, Knob-on-Display, maxCrypto, maxView, memBrain, Mindi, MiWi, MPASM, MPF, MPLAB Certified logo, MPLIB, MPLINK, MultiTRAK, NetDetach, NVM Express, NVMe, Omniscient Code Generation, PICDEM, PICDEM.net, PICkit, PICtail, PowerSmart, PureSilicon, QMatrix, REAL ICE, Ripple Blocker, RTAX, RTG4, SAM-ICE, Serial Quad I/O, simpleMAP, SimpliPHY, SmartBuffer, SmartHLS, SMART-I.S., storClad, SQI, SuperSwitcher, SuperSwitcher II, Switchtec, SynchroPHY, Total Endurance, TSHARC, USBCheck, VariSense, VectorBlox, VeriPHY, ViewSpan, WiperLock, XpressConnect, and ZENA are trademarks of Microchip Technology Incorporated in the U.S.A. and other countries.

SQTP is a service mark of Microchip Technology Incorporated in the U.S.A.

The Adaptec logo, Frequency on Demand, Silicon Storage Technology, Symmcom, and Trusted Time are registered trademarks of Microchip Technology Inc. in other countries.

GestIC is a registered trademark of Microchip Technology Germany II GmbH & Co. KG, a subsidiary of Microchip Technology Inc., in other countries.

All other trademarks mentioned herein are property of their respective companies.

© 2021 - 2022, Microchip Technology Incorporated and its subsidiaries.

All Rights Reserved.

ISBN: 978-1-6683-0342-9



MICROCHIP

Worldwide Sales and Service

4AMERICAS

Corporate Office
2355 West Chandler Blvd.
Chandler, AZ 85224-6199
Tel: 480-792-7200
Fax: 480-792-7277
Technical Support:
<http://www.microchip.com/support>
Web Address:
www.microchip.com

Atlanta

Duluth, GA
Tel: 678-957-9614
Fax: 678-957-1455

Austin, TX

Tel: 512-257-3370

Boston

Westborough, MA
Tel: 774-760-0087
Fax: 774-760-0088

Chicago

Itasca, IL
Tel: 630-285-0071
Fax: 630-285-0075

Dallas

Addison, TX
Tel: 972-818-7423
Fax: 972-818-2924

Detroit

Novi, MI
Tel: 248-848-4000

Houston, TX

Tel: 281-894-5983

Indianapolis

Noblesville, IN
Tel: 317-773-8323
Fax: 317-773-5453
Tel: 317-536-2380

Los Angeles

Mission Viejo, CA
Tel: 949-462-9523
Fax: 949-462-9608
Tel: 951-273-7800

Raleigh, NC

Tel: 919-844-7510

New York, NY

Tel: 631-435-6000

San Jose, CA

Tel: 408-735-9110
Tel: 408-436-4270

Canada - Toronto

Tel: 905-695-1980
Fax: 905-695-2078

ASIA/PACIFIC

Australia - Sydney
Tel: 61-2-9868-6733

China - Beijing
Tel: 86-10-8569-7000

China - Chengdu
Tel: 86-28-8665-5511

China - Chongqing
Tel: 86-23-8980-9588

China - Dongguan
Tel: 86-769-8702-9880

China - Guangzhou
Tel: 86-20-8755-8029

China - Hangzhou
Tel: 86-571-8792-8115

China - Hong Kong SAR
Tel: 852-2943-5100

China - Nanjing
Tel: 86-25-8473-2460

China - Qingdao
Tel: 86-532-8502-7355

China - Shanghai
Tel: 86-21-3326-8000

China - Shenyang
Tel: 86-24-2334-2829

China - Shenzhen
Tel: 86-755-8864-2200

China - Suzhou
Tel: 86-186-6233-1526

China - Wuhan
Tel: 86-27-5980-5300

China - Xian
Tel: 86-29-8833-7252

China - Xiamen
Tel: 86-592-2388138

China - Zhuhai
Tel: 86-756-3210040

ASIA/PACIFIC

India - Bangalore
Tel: 91-80-3090-4444

India - New Delhi
Tel: 91-11-4160-8631

India - Pune
Tel: 91-20-4121-0141

Japan - Osaka
Tel: 81-6-6152-7160

Japan - Tokyo
Tel: 81-3-6880-3770

Korea - Daegu
Tel: 82-53-744-4301

Korea - Seoul
Tel: 82-2-554-7200

Malaysia - Kuala Lumpur
Tel: 60-3-7651-7906

Malaysia - Penang
Tel: 60-4-227-8870

Philippines - Manila
Tel: 63-2-634-9065

Singapore
Tel: 65-6334-8870

Taiwan - Hsin Chu
Tel: 886-3-577-8366

Taiwan - Kaohsiung
Tel: 886-7-213-7830

Taiwan - Taipei
Tel: 886-2-2508-8600

Thailand - Bangkok
Tel: 66-2-694-1351

Vietnam - Ho Chi Minh
Tel: 84-28-5448-2100

EUROPE

Austria - Wels
Tel: 43-7242-2244-39
Fax: 43-7242-2244-393

Denmark - Copenhagen
Tel: 45-4485-5910
Fax: 45-4485-2829

Finland - Espoo
Tel: 358-9-4520-820

France - Paris
Tel: 33-1-69-53-63-20
Fax: 33-1-69-30-90-79

Germany - Garching
Tel: 49-8931-9700

Germany - Haan
Tel: 49-2129-3766400

Germany - Heilbronn
Tel: 49-7131-72400

Germany - Karlsruhe
Tel: 49-721-625370

Germany - Munich
Tel: 49-89-627-144-0
Fax: 49-89-627-144-44

Germany - Rosenheim
Tel: 49-8031-354-560

Israel - Ra'anana
Tel: 972-9-744-7705

Italy - Milan
Tel: 39-0331-742611
Fax: 39-0331-466781

Italy - Padova
Tel: 39-049-7625286

Netherlands - Drunen
Tel: 31-416-690399
Fax: 31-416-690340

Norway - Trondheim
Tel: 47-7288-4388

Poland - Warsaw
Tel: 48-22-3325737

Romania - Bucharest
Tel: 40-21-407-87-50

Spain - Madrid
Tel: 34-91-708-08-90
Fax: 34-91-708-08-91

Sweden - Gothenberg
Tel: 46-31-704-60-40

Sweden - Stockholm
Tel: 46-8-5090-4654

UK - Wokingham
Tel: 44-118-921-5800
Fax: 44-118-921-5820