

## LMH9126 2.3–2.9-GHz Differential to Single-Ended Amplifier With Integrated Balun

### 1 Features

- Single-Channel, Differential Input to Single-Ended Output RF Gain Block Amplifier
- 18-dB Typical Gain Across the Band
- 3.5-dB Noise Figure
- 35-dBm OIP3
- 18-dBm Output P1dB
- 375-mW Power Consumption on 3.3-V Single Supply
- Up to 105°C T<sub>C</sub> Operating Temperature

### 2 Applications

- Differential DAC Output Driver for GPS DACs
- Differential to Single-Ended Conversions
- Balun Alternatives
- [Small Cell](#) or [m-MIMO](#) Base Stations
- [5G Active Antenna Systems \(AAS\)](#)
- [Wireless Cellular Base Station](#)

### 3 Description

The LMH9126 is high-performance, single-channel, differential input to single-ended output transmit RF gain block amplifier supporting 2.6-GHz center frequency band. The device is well suited to support requirements for the next generation 5G AAS or small cell applications while driving the input of a power amplifier (PA). The RF amplifier provides 18-dB typical gain with good linearity performance of 35-dBm output IP3, while maintaining less than 4-dB noise figure across the whole 1-dB bandwidth. The device is internally matched for 100-Ω differential input impedance providing easy interface with an RF-sampling or Zero-IF analog front-end (AFE) at the input. Also, the device is internally matched for 50-Ω single-ended output impedance required for easy interface with a post-amplifier, SAW filter, or PA.

Operating on a single 3.3-V supply, the device consumes only 375 mW of active power making it suitable for high-density 5G massive MIMO applications. Also, the device is available in a space saving 2-mm × 2-mm, 12-pin QFN package. The device is rated for an operating temperature of up to 105°C to provide a robust system design. There is a 1.8-V JEDEC compliant power down pin available for fast power down and power up of the device suitable for time division duplex (TDD) systems.

#### Device Information<sup>(1)</sup>

PART NUMBER	PACKAGE	BODY SIZE (NOM)
LMH9126	WQFN (12)	2.00 mm × 2.00 mm

(1) For all available packages, see the orderable addendum at the end of the data sheet.

#### LMH9126: Differential to Single-Ended Amplifier

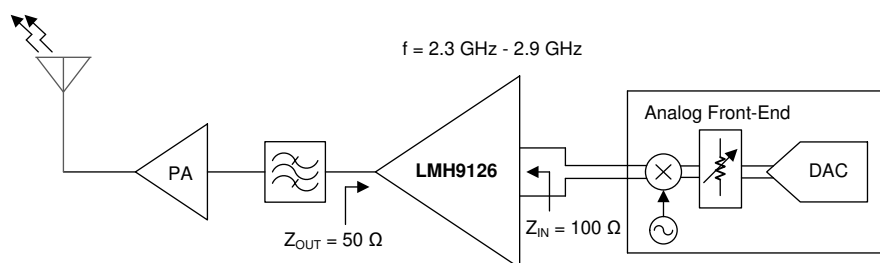

## Table of Contents

<b>1 Features</b> .....	<b>1</b>	7.4 Device Functional Modes.....	<b>11</b>
<b>2 Applications</b> .....	<b>1</b>	<b>8 Application and Implementation</b> .....	<b>11</b>
<b>3 Description</b> .....	<b>1</b>	8.1 Application Information.....	<b>11</b>
<b>4 Revision History</b> .....	<b>2</b>	8.2 Typical Application .....	<b>11</b>
<b>5 Pin Configuration and Functions</b> .....	<b>3</b>	<b>9 Power Supply Recommendations</b> .....	<b>14</b>
<b>6 Specifications</b> .....	<b>4</b>	<b>10 Layout</b> .....	<b>15</b>
6.1 Absolute Maximum Ratings .....	4	10.1 Layout Guidelines .....	15
6.2 ESD Ratings.....	4	10.2 Layout Example .....	15
6.3 Recommended Operating Conditions.....	4	<b>11 Device and Documentation Support</b> .....	<b>16</b>
6.4 Thermal Information .....	4	11.1 Documentation Support .....	16
6.5 Electrical Characteristics.....	4	11.2 Receiving Notification of Documentation Updates	16
6.6 Typical Characteristics.....	6	11.3 Support Resources .....	16
<b>7 Detailed Description</b> .....	<b>10</b>	11.4 Trademarks .....	16
7.1 Overview .....	10	11.5 Electrostatic Discharge Caution.....	16
7.2 Functional Block Diagram .....	10	11.6 Glossary .....	16
7.3 Feature Description.....	10	<b>12 Mechanical, Packaging, and Orderable Information</b> .....	<b>16</b>

## 4 Revision History

NOTE: Page numbers for previous revisions may differ from page numbers in the current version.

DATE	REVISION	NOTES
June 2020	*	Initial Release

## 5 Pin Configuration and Functions

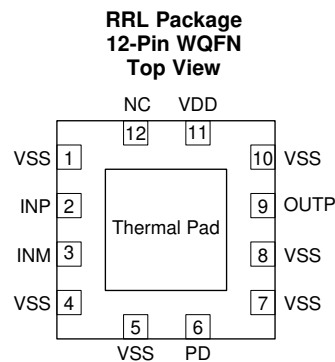

### Pin Functions

PIN		TYPE	DESCRIPTION
NO.	NAME		
1	VSS	Power	Ground
2	INP	Input	RF differential positive input into amplifier
3	INM	Power	RF differential negative input into amplifier
4	VSS	Power	Ground
5	VSS	Power	Ground
6	PD	Input	Power down connection. PD = 0 V = normal operation; PD = 1.8 V = power off mode
7	VSS	Power	Ground
8	VSS	Output	Ground
9	OUTP	Output	RF single-ended output from amplifier
10	VSS	Power	Ground
11	VDD	Power	Positive supply voltage (3.3 V)
12	NC	—	Do not connect this pin
Thermal Pad		—	Connect the thermal pad to ground

## 6 Specifications

### 6.1 Absolute Maximum Ratings

over operating free-air temperature range (unless otherwise noted)<sup>(1)</sup>

		MIN	MAX	UNIT
Supply voltage	VDD	-0.3	3.6	V
RF pins	INP, INM, OUTP	-0.3	VDD	V
Digital input pin	PD	-0.3	VDD	V
Continuous wave (CW) input	T = 25 °C		18	dBm
T <sub>J</sub>	Junction temperature		150	°C
T <sub>stg</sub>	Storage temperature	-65	150	°C

(1) Stresses beyond those listed under *Absolute Maximum Rating* may cause permanent damage to the device. These are stress ratings only, which do not imply functional operation of the device at these or any other conditions beyond those indicated under *Recommended Operating Condition*. Exposure to absolute-maximum-rated conditions for extended periods may affect device reliability.

### 6.2 ESD Ratings

			VALUE	UNIT
V <sub>(ESD)</sub>	Electrostatic discharge	Human body model (HBM), per ANSI/ESDA/JEDEC JS-001, all pins <sup>(1)</sup>	±1000	V
		Charged device model (CDM), per JEDEC specification JESD22-C101, all pins <sup>(2)</sup>	±500	

(1) JEDEC document JEP155 states that 500-V HBM allows safe manufacturing with a standard ESD control process.

(2) JEDEC document JEP157 states that 250-V CDM allows safe manufacturing with a standard ESD control process.

### 6.3 Recommended Operating Conditions

over operating free-air temperature range (unless otherwise noted)

		MIN	NOM	MAX	UNIT
VDD	Supply voltage	3.15	3.3	3.45	V
T <sub>C</sub>	Case (bottom) temperature	-40		105	°C
T <sub>J</sub>	Junction temperature	-40		125	°C

### 6.4 Thermal Information

THERMAL <sup>(1)</sup>		LMH9126	UNIT
		RRL PKG	
		12-PIN WQFN	
R <sub>θJA</sub>	Junction-to-ambient thermal resistance	74.8	°C/W
R <sub>θJC(top)</sub>	Junction-to-case (top) thermal resistance	72.4	°C/W
R <sub>θJB</sub>	Junction-to-board thermal resistance	37.1	°C/W
Ψ <sub>JT</sub>	Junction-to-top characterization parameter	3.2	°C/W
Ψ <sub>JB</sub>	Junction-to-board characterization parameter	37.1	°C/W
R <sub>θJC(bot)</sub>	Junction-to-case (bottom) thermal resistance	14.2	°C/W

(1) For more information about traditional and new thermal metrics, see the *IC Package Thermal Metrics* application report, [SPRA953](#)

### 6.5 Electrical Characteristics

T<sub>A</sub> = 25°C, VDD = 3.3 V, frequency (f<sub>in</sub>) = 2.6 GHz, differential input impedance (Z<sub>IN</sub>) = 100 Ω, output load (Z<sub>LOAD</sub>) = 50 Ω (unless otherwise noted)

PARAMETER		TEST CONDITIONS	MIN	TYP	MAX	UNIT
<b>RF PERFORMANCE</b>						
f <sub>RF</sub>	RF frequency range		2300		2900	MHz
BW <sub>1dB</sub>	1-dB bandwidth			600		MHz

## Electrical Characteristics (continued)

$T_A = 25^\circ\text{C}$ ,  $V_{DD} = 3.3\text{ V}$ , frequency ( $f_{in}$ ) = 2.6 GHz, differential input impedance ( $Z_{IN}$ ) = 100  $\Omega$ , output load ( $Z_{LOAD}$ ) = 50  $\Omega$  (unless otherwise noted)

PARAMETER		TEST CONDITIONS	MIN	TYP	MAX	UNIT
$S_{21}$	Gain			18		dB
NF	Noise figure	$R_S = 100\ \Omega$ differential		3.5		dB
OP1dB	Output P1dB	$Z_{LOAD} = 50\ \Omega$		18		dBm
OIP3	Output IP3	$f_{in} = 2.6\text{ GHz} \pm 5\text{-MHz spacing}$ , $P_{OUT/TONE} = 2\text{ dBm}$		36		dBm
	Differential input gain imbalance			$\pm 0.3$		dB
	Differential input phase imbalance			$\pm 4$		$^\circ$
$S_{11}$	Input return loss <sup>(1)</sup>	$f_{in} = 2.6\text{ GHz}$ , BW = 200 MHz		-15		dB
		$f_{in} = 2.6\text{ GHz}$ , BW = 600 MHz		-8		
$S_{22}$	Output return loss <sup>(1)</sup>	$f_{in} = 2.6\text{ GHz}$ , BW = 200 MHz		-10		dB
		$f_{in} = 2.6\text{ GHz}$ , BW = 600 MHz		-10		
$S_{12}$	Reverse isolation	$f_{in} = 2.6\text{ GHz}$ , BW = 600 MHz		-35		dB
CMRR	Common mode rejection ratio <sup>(2)</sup>			30		dB
<b>SWITCHING AND DIGITAL INPUT CHARACTERISTICS</b>						
$t_{ON}$	Turn-ON time	50% $V_{PD}$ to 90% RF		0.2		$\mu\text{s}$
$t_{OFF}$	Turn-OFF time	50% $V_{PD}$ to 10% RF		0.2		$\mu\text{s}$
$V_{IH}$	High-level input voltage	PD pin	1.4			V
$V_{IL}$	Low-level input voltage	PD pin			0.5	V
<b>DC CURRENT AND POWER CONSUMPTION</b>						
$I_{VDD\_ON}$	Supply current - active	$V_{PD} = 0\text{ V}$		114		mA
$I_{VDD\_PD}$	Supply current - power down	$V_{PD} = 1.8\text{ V}$		10		mA
$P_{dis}$	Power dissipation - active	$V_{DD} = 3.3\text{ V}$		375		mW

(1) Reference impedance: Input = 100  $\Omega$  differential, Output = 50  $\Omega$  single-ended.

(2) CMRR is calculated using  $(S_{12} - S_{13}) / (S_{12} + S_{13})$  for transmit (1 is output port, 2 & 3 are differential input ports).

### 6.6 Typical Characteristics

at  $T_A = 25^\circ\text{C}$ ,  $V_{DD} = 3.3\text{ V}$ , differential input impedance ( $Z_{IN}$ ) =  $100\ \Omega$ , single-ended output impedance ( $Z_{LOAD}$ ) =  $50\ \Omega$ , and  $P_{OUT(TOTAL)} = 8\text{ dBm}$  into  $Z_{LOAD} = 50\ \Omega$  (unless otherwise noted)

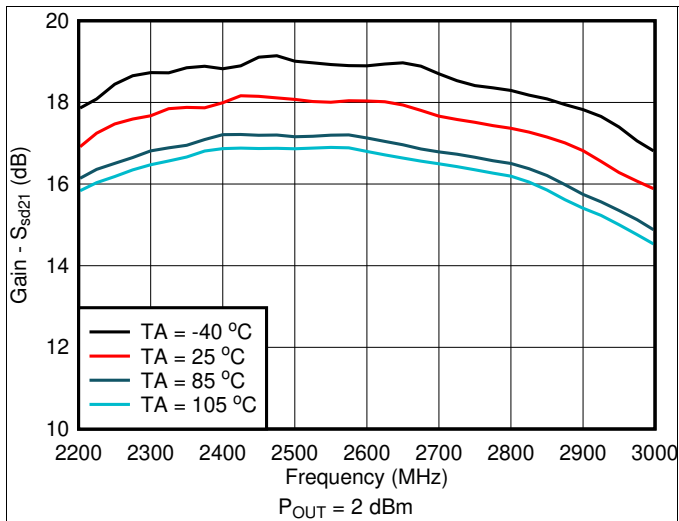

Figure 1. Gain vs Frequency and Temperature

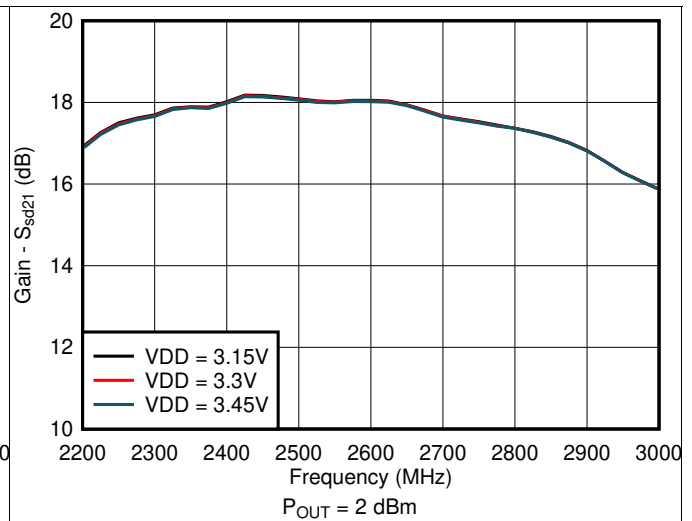

Figure 2. Gain vs Frequency and Supply Voltage

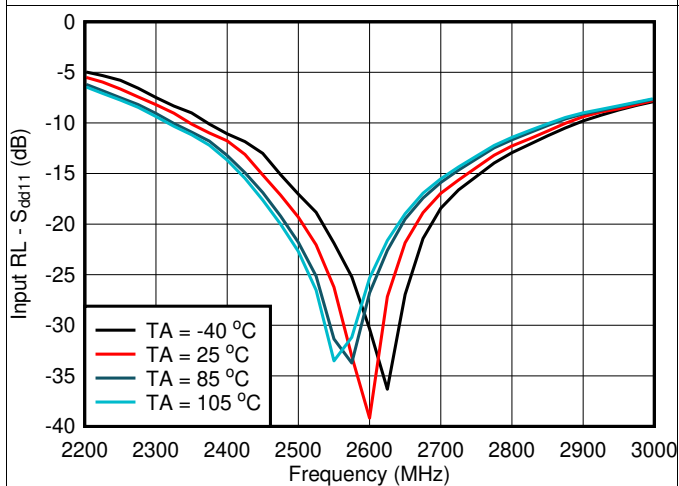

Figure 3. Input Return Loss vs Frequency

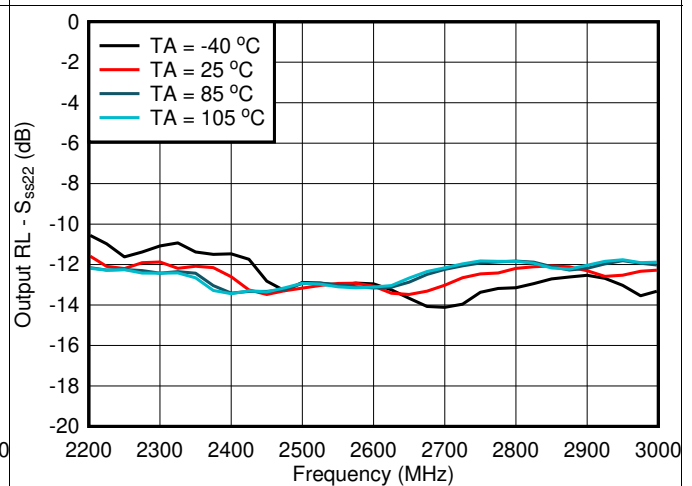
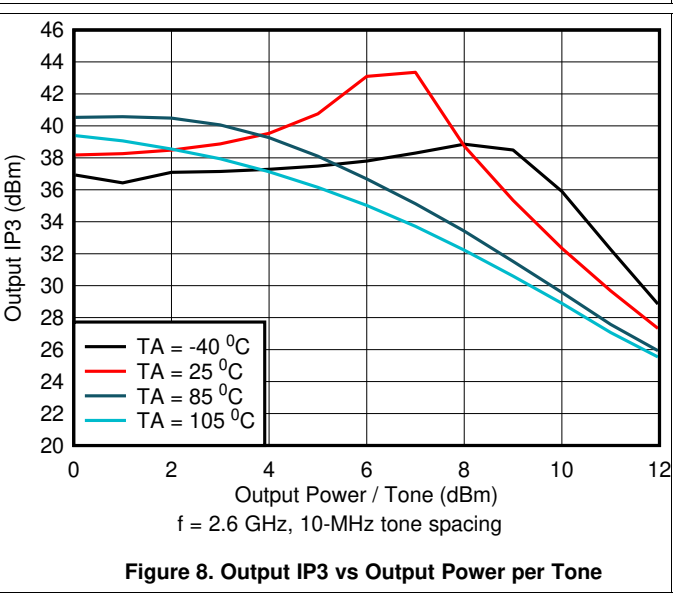
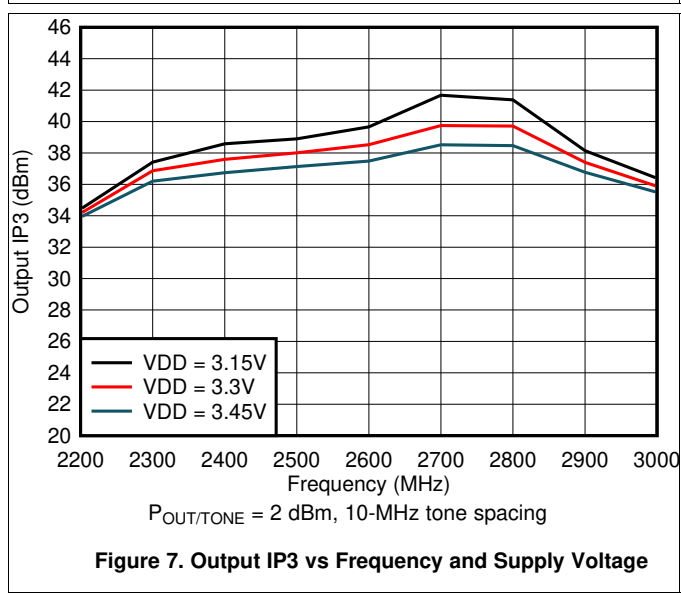
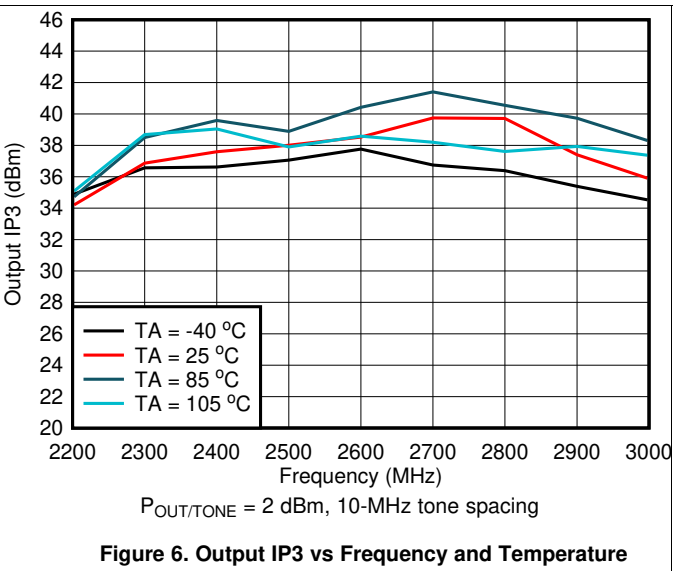
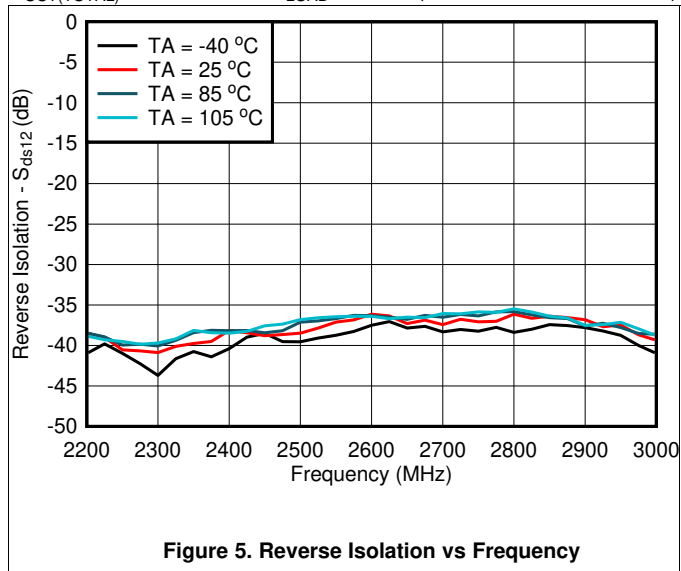

Figure 4. Output Return Loss vs Frequency

**Typical Characteristics (continued)**

at  $T_A = 25^\circ\text{C}$ ,  $V_{DD} = 3.3\text{ V}$ , differential input impedance ( $Z_{IN}$ ) =  $100\ \Omega$ , single-ended output impedance ( $Z_{LOAD}$ ) =  $50\ \Omega$ , and  $P_{OUT(TOTAL)} = 8\text{ dBm}$  into  $Z_{LOAD} = 50\ \Omega$  (unless otherwise noted)



### Typical Characteristics (continued)

at  $T_A = 25^\circ\text{C}$ ,  $V_{DD} = 3.3\text{ V}$ , differential input impedance ( $Z_{IN}$ ) =  $100\ \Omega$ , single-ended output impedance ( $Z_{LOAD}$ ) =  $50\ \Omega$ , and  $P_{OUT(TOTAL)} = 8\text{ dBm}$  into  $Z_{LOAD} = 50\ \Omega$  (unless otherwise noted)

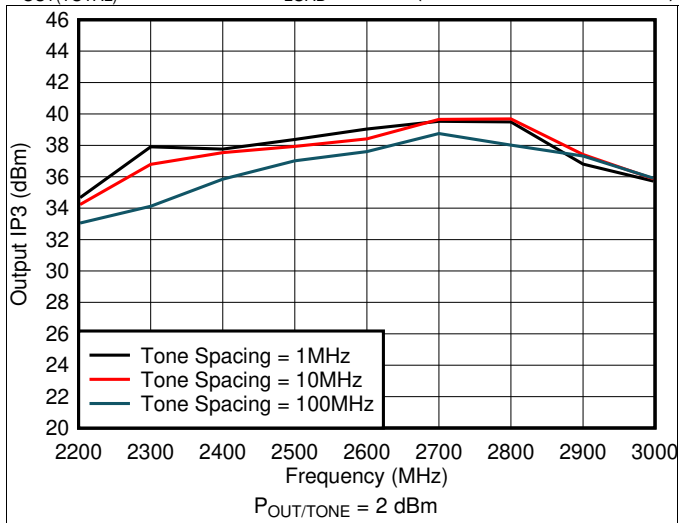

Figure 9. Output IP3 vs Frequency and Tone Spacing

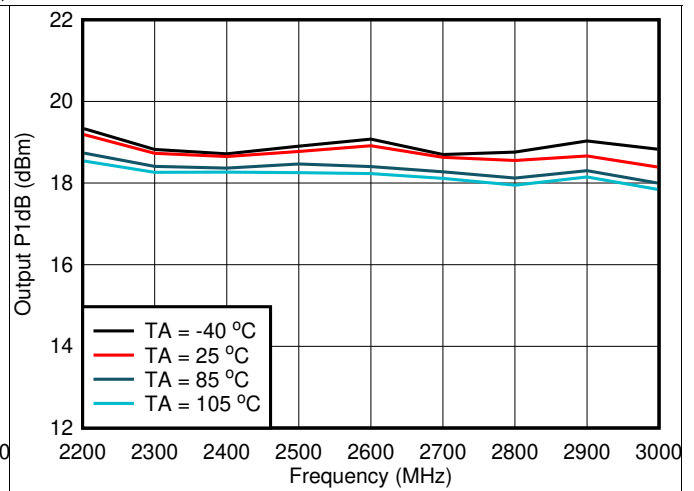

Figure 10. Output P1dB vs Frequency and Temperature

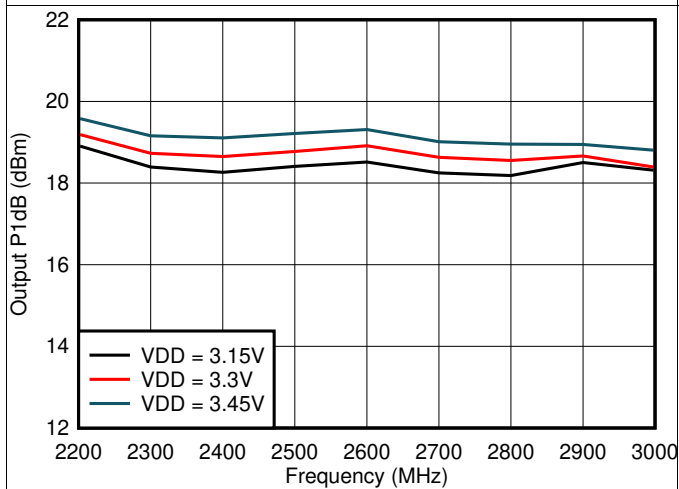

Figure 11. Output P1dB vs Frequency and Supply Voltage

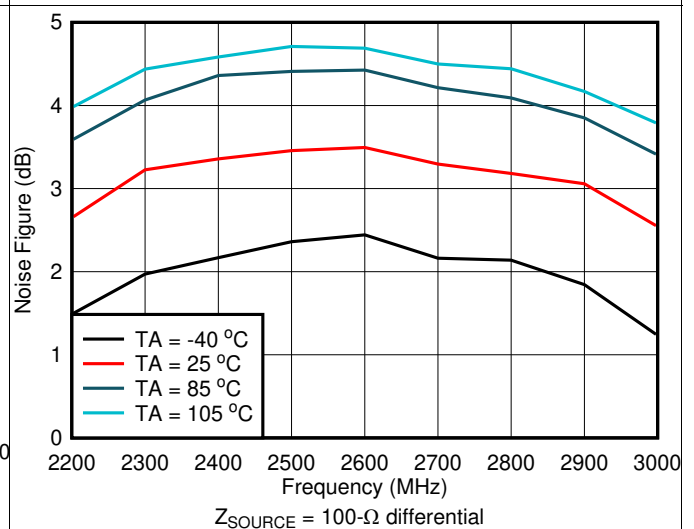

Figure 12. Noise Figure vs Frequency and Temperature



Typical Characteristics (continued)

at  $T_A = 25^\circ\text{C}$ ,  $V_{DD} = 3.3\text{ V}$ , differential input impedance ( $Z_{IN}$ ) =  $100\ \Omega$ , single-ended output impedance ( $Z_{LOAD}$ ) =  $50\ \Omega$ , and  $P_{OUT(TOTAL)} = 8\text{ dBm}$  into  $Z_{LOAD} = 50\ \Omega$  (unless otherwise noted)

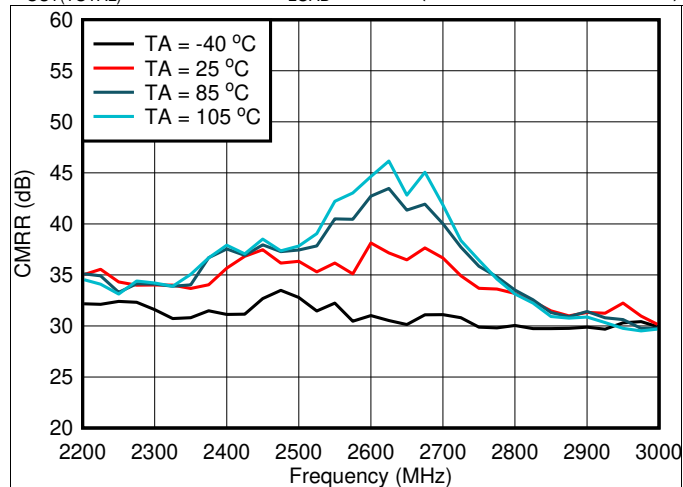

Figure 13. CMRR vs Frequency

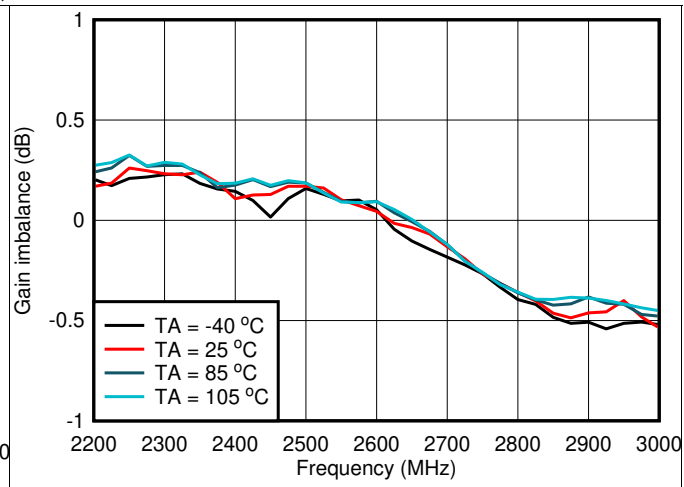

Figure 14. Gain Imbalance vs Frequency and Temperature

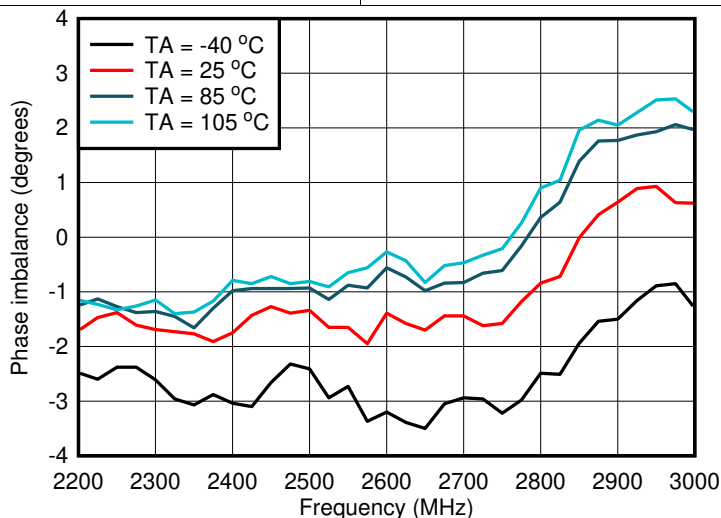

Figure 15. Phase Imbalance vs Frequency and Temperature

## 7 Detailed Description

### 7.1 Overview

The LMH9126 device is a differential input to single-ended output narrow-band RF amplifier that is used in transmitter applications. The device provides 18-dB fixed power gain with excellent linearity and noise performance across 1-dB bandwidth of the 2.6-GHz center frequency. The device is internally matched for 100-Ω differential impedance at the input and 50-Ω impedance at the output, as shown in Figure 16.

The LMH9126 has on-chip active bias circuitry to maintain device performance over a wide temperature and supply voltage range. The included power down (PD) function allows the amplifier to shut down. The PD function is useful to save power when the amplifier is not needed and also allows to mute the transmitter when in receive mode. Fast shut down and start up enable the amplifier to be used in a host of TDD applications.

Operating on a single 3.3-V supply and 114 mA of typical supply current, the devices are available in a 2-mm × 2-mm 12-pin QFN package.

### 7.2 Functional Block Diagram

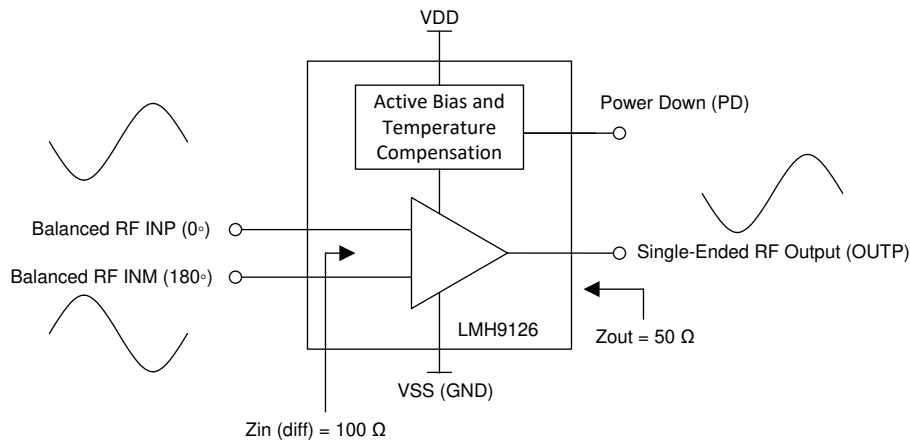

Figure 16. Functional Block Diagram

### 7.3 Feature Description

The LMH9126 device is a differential to single-ended RF amplifier for narrow band active balun implementation. The device integrates the functionality of a passive balun and a single-ended RF amplifier in traditional transmitter applications achieving small form factor with comparable linearity and noise performance, as shown in Figure 17.

The active balun implementation coupled with higher operating temperature of 105°C allows for more robust system implementation compared to passive balun that is prone to reliability failures at high temperatures. The robust operation is achieved by the on-chip active bias circuitry which maintains device performance over a wide temperature and supply voltage range.

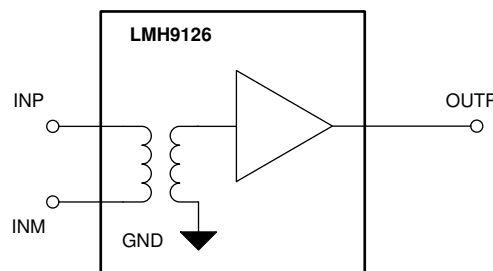

Figure 17. Differential Input to Single-Ended Output, Active Balun Implementation

## 7.4 Device Functional Modes

The LMH9126 features a PD pin which should be connected to GND for normal operation. To power down the device, connect the PD pin to a logic high voltage of 1.8 V.

## 8 Application and Implementation

---

### NOTE

Information in the following applications sections is not part of the TI component specification, and TI does not warrant its accuracy or completeness. TI's customers are responsible for determining suitability of components for their purposes. Customers should validate and test their design implementation to confirm system functionality.

---

### 8.1 Application Information

The LMH9126 is a differential to single-ended RF gain block amplifier, which works as an active balun in the transmit path of a 2.3-GHz to 2.8-GHz 5G, TDD m-MIMO or small cell base station. The device replaces the traditional passive balun and single-ended RF amplifier offering a smaller footprint solution to the customer. TI recommends following good RF layout and grounding techniques to maximize the device performance.

### 8.2 Typical Application

The LMH9126 is typically used in a four transmit and four receive (4T/4R) array of active antenna system for 5G, TDD, wireless base station applications. Such a system is shown in [Figure 18](#), where the LMH9126 is used in the transmit path as an active balun that converts differential DAC output from Tx AFE to single-ended signal. Also shown in the figure is the application of LMH9226 chip, which is the counter-part of LMH9126 in the Receive path.

Typical Application (continued)

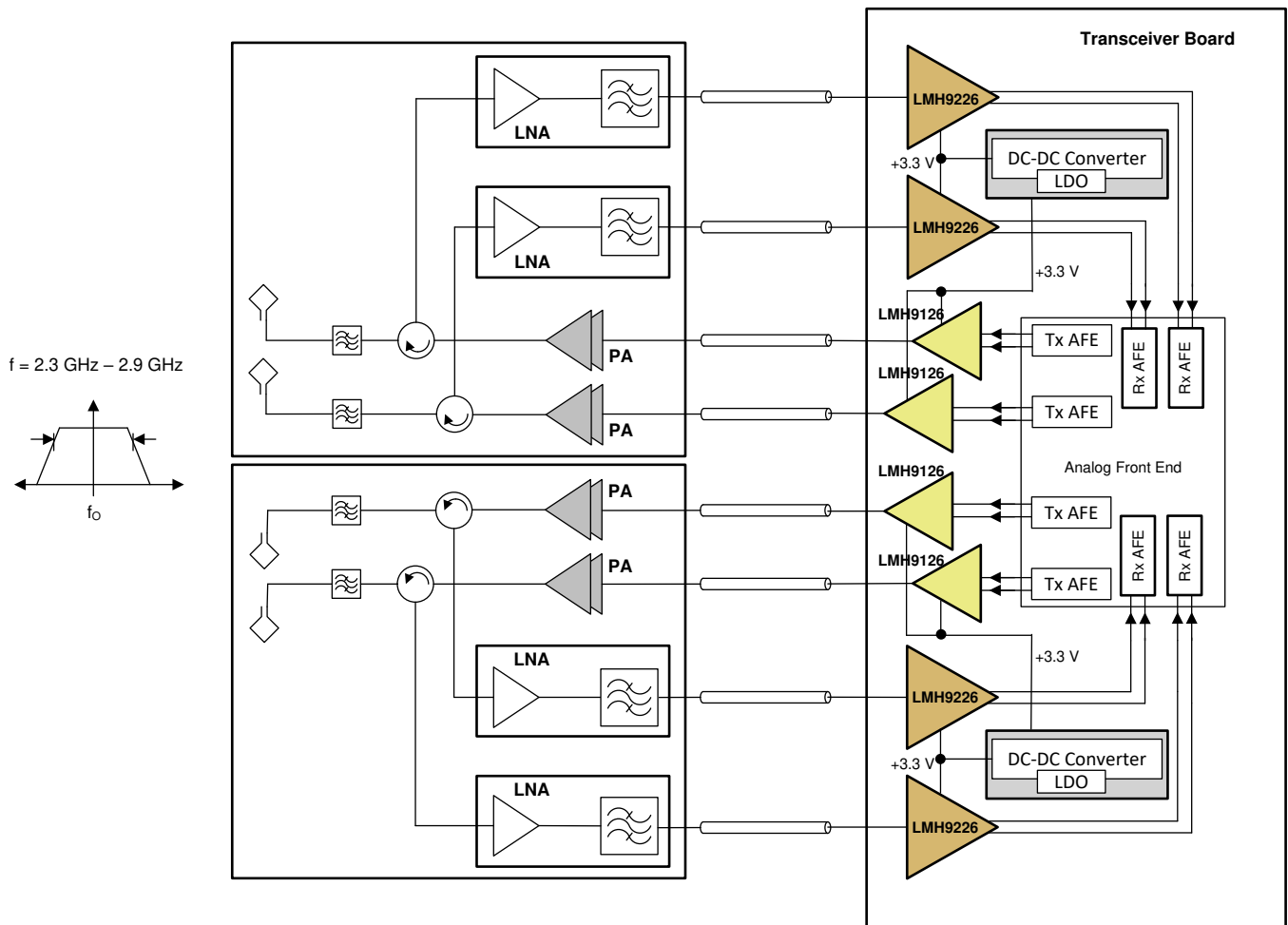

Figure 18. LMH9126 in a 4T/4R 5G Active Antenna System

The 4T/4R system can be scaled to 16T/16R, 64T/64R, or higher antenna arrays that result in proportional scaling of the overall system power dissipation. As a result of the proportional scaling factor for multiple channels in a system, the individual device power consumption must be reduced to dissipate less overall heat in the system. Operating on a single 3.3-V supply, the LMH9126 consumes only 375 mW and therefore provides power saving to the customer. Multiple LMH9126 devices can be powered from a single DC/DC converter or a low-dropout regulator (LDO) operating on a 3.3-V supply. A DC/DC converter provides the most power efficient way of generating the 3.3-V supply. However, care must be taken when using the DC/DC converter to minimize the switching noise using inductor chokes and adequate isolation must be provided between the analog and digital supplies.

## Typical Application (continued)

### 8.2.1 Design Requirements

Input of LMH9126 is matched to 100 Ω and therefore can be directly driven by a DAC that has 100 Ω termination without any external matching network. If a DAC with different termination is used, then it should be appropriately matched to get the best RF performance.

The example in [Figure 19](#) shows how LMH9126 can be matched to a DAC that has 200-Ω differential termination.

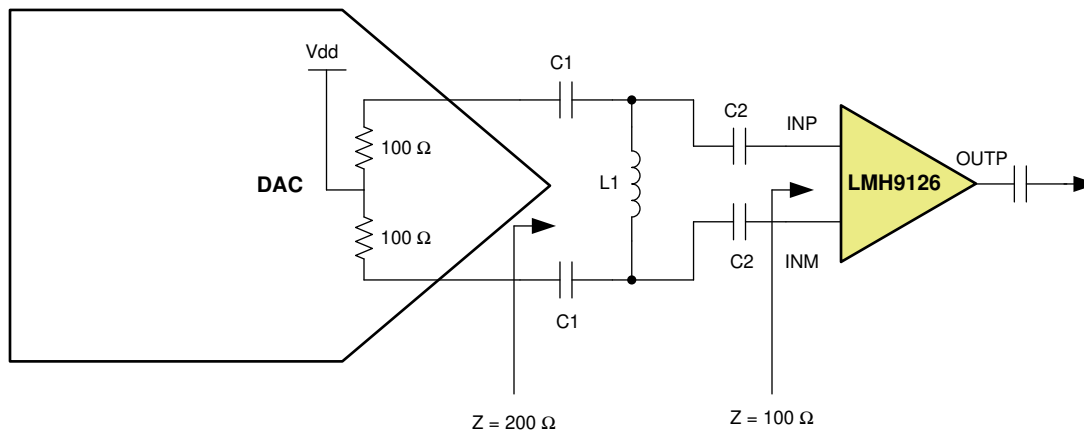

**Figure 19. LMH9126 Driven by a DAC With 200-Ω Termination**

### 8.2.2 Detailed Design Procedure

A simple differential LC network is used here as the matching network. In [Figure 19](#), shunt inductor L1 and series capacitors C2 form the matching network. The series capacitors C1 act as the DC-blocking capacitors. [Table 1](#) shows the matching network component values.

**Table 1. Matching Network Component Values**

COMPONENT	VALUE
C1	12 pF
L1	10 nH
C2	1.2 pF

### 8.2.3 Application Curves

The graphs given below show the Gain, Input Return Loss, and Output Return Loss of the design with different DAC terminations.

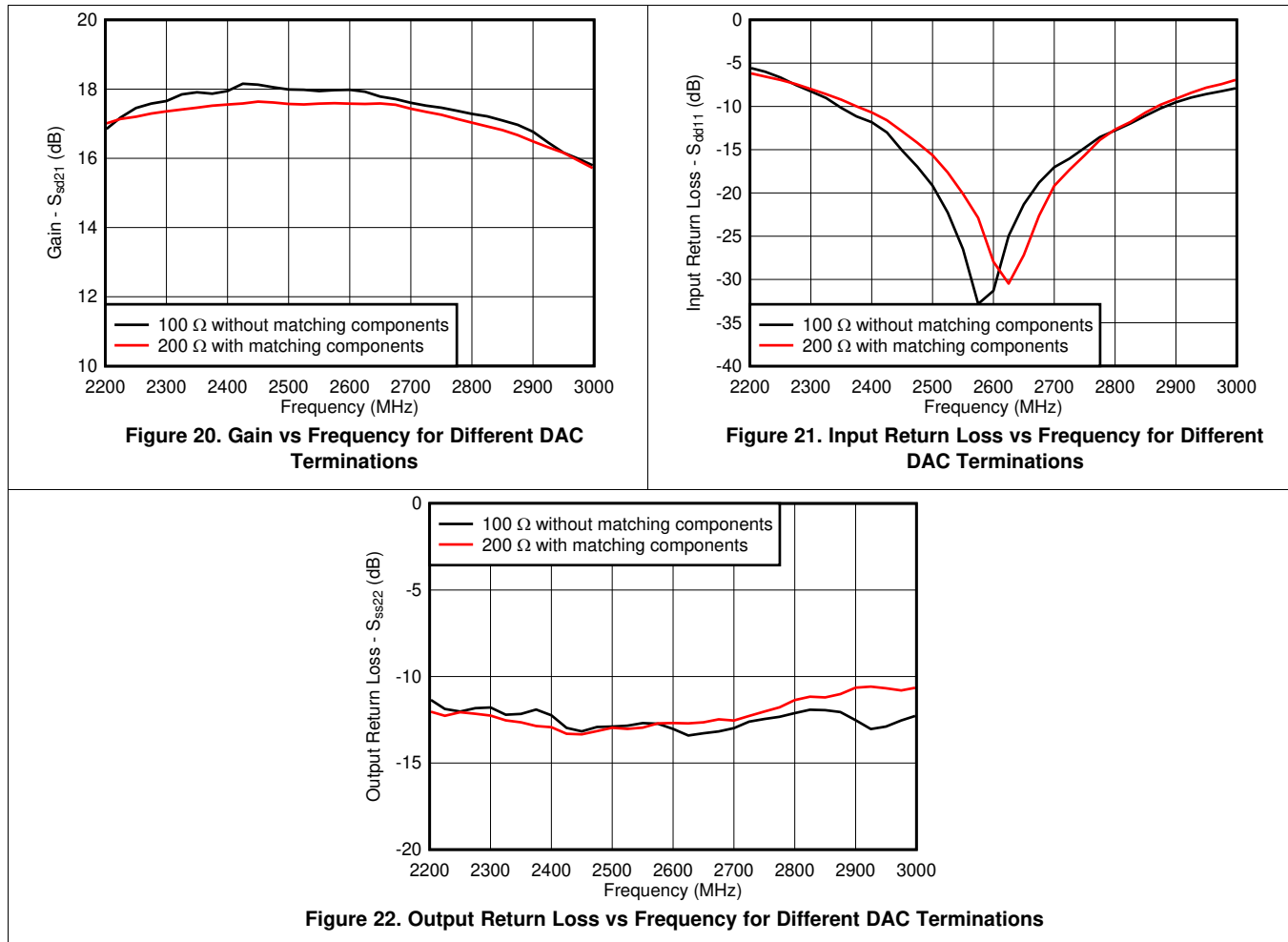

## 9 Power Supply Recommendations

The LMH9126 device operates on a single nominal 3.3-V supply voltage. It is recommended to isolate the supply voltage through decoupling capacitors placed close to the device. Select capacitors with self-resonant frequency above the application frequency. When multiple capacitors are used in parallel to create a broadband decoupling network, place the capacitor with the higher self-resonant frequency closer to the device.

## 10 Layout

### 10.1 Layout Guidelines

When designing with an RF amplifier operating in the frequency range 2 GHz to 3 GHz with relatively high gain, certain board layout precautions must be taken to ensure stability and optimum performance. TI recommends that the LMH9126 board be multi-layered to improve thermal performance, grounding, and power-supply decoupling. [Figure 23](#) shows a good layout example. In this figure, only the top signal layer is shown.

- Excellent electrical connection from the thermal pad to the board ground is essential. Use the recommended footprint, solder the pad to the board, and do not include a solder mask under the pad.
- Connect the pad ground to the device terminal ground on the top board layer.
- Ensure that ground planes on the top and any internal layers are well stitched with vias.
- Design the two input and one output RF traces for 50-Ω impedance. TI recommends grounded coplanar waveguide (GCPW) type transmission lines for the RF traces. Use a PCB trace width calculator tool to design the transmission lines.
- Avoid routing clocks and digital control lines near RF signal lines.
- Do not route RF or DC signal lines over noisy power planes.
- Place supply decoupling close to the device.
- The differential output traces must be symmetrical in order to achieve the best differential balance and linearity performance.

See the [LMH9126 Evaluation Module user's guide](#) for more details on board layout and design.

### 10.2 Layout Example

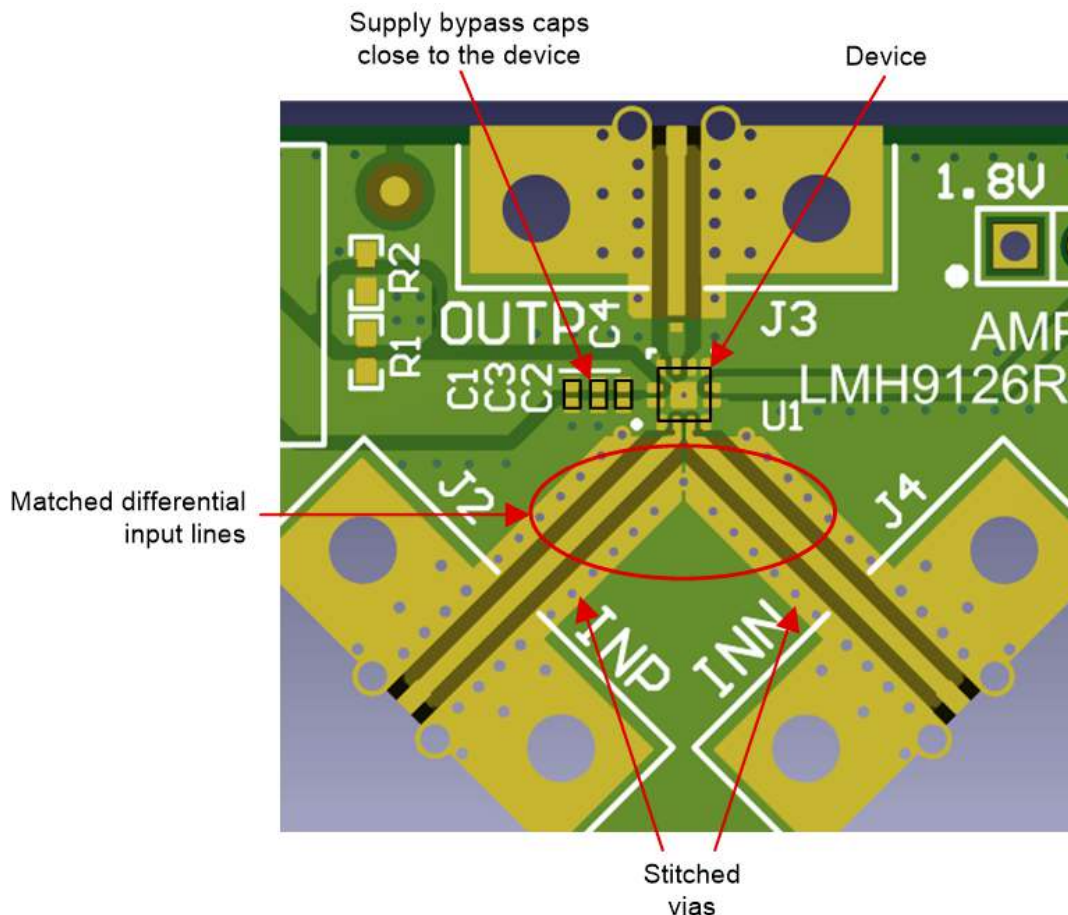

**Figure 23. Layout Showing Matched Differential Traces and Supply Decoupling**

## 11 Device and Documentation Support

### 11.1 Documentation Support

#### 11.1.1 Related Documentation

For related documentation see the following:

- Texas Instruments, [LMH9126 Evaluation Module user's guide](#)

### 11.2 Receiving Notification of Documentation Updates

To receive notification of documentation updates, navigate to the device product folder on ti.com. In the upper right corner, click on *Alert me* to register and receive a weekly digest of any product information that has changed. For change details, review the revision history included in any revised document.

### 11.3 Support Resources

TI E2E™ support forums are an engineer's go-to source for fast, verified answers and design help — straight from the experts. Search existing answers or ask your own question to get the quick design help you need.

Linked content is provided "AS IS" by the respective contributors. They do not constitute TI specifications and do not necessarily reflect TI's views; see TI's [Terms of Use](#).

### 11.4 Trademarks

E2E is a trademark of Texas Instruments.

All other trademarks are the property of their respective owners.

### 11.5 Electrostatic Discharge Caution



This integrated circuit can be damaged by ESD. Texas Instruments recommends that all integrated circuits be handled with appropriate precautions. Failure to observe proper handling and installation procedures can cause damage.

ESD damage can range from subtle performance degradation to complete device failure. Precision integrated circuits may be more susceptible to damage because very small parametric changes could cause the device not to meet its published specifications.

### 11.6 Glossary

[SLYZ022](#) — *TI Glossary*.

This glossary lists and explains terms, acronyms, and definitions.

## 12 Mechanical, Packaging, and Orderable Information

The following pages include mechanical, packaging, and orderable information. This information is the most current data available for the designated devices. This data is subject to change without notice and revision of this document. For browser-based versions of this data sheet, refer to the left-hand navigation.



**PACKAGING INFORMATION**

Orderable Device	Status (1)	Package Type	Package Drawing	Pins	Package Qty	Eco Plan (2)	Lead finish/ Ball material (6)	MSL Peak Temp (3)	Op Temp (°C)	Device Marking (4/5)	Samples
LMH9126IRRLR	ACTIVE	WQFN	RRL	12	3000	RoHS & Green	NIPDAUAG	Level-2-260C-1 YEAR	-40 to 105	12GO	Samples

(1) The marketing status values are defined as follows:

**ACTIVE:** Product device recommended for new designs.

**LIFEBUY:** TI has announced that the device will be discontinued, and a lifetime-buy period is in effect.

**NRND:** Not recommended for new designs. Device is in production to support existing customers, but TI does not recommend using this part in a new design.

**PREVIEW:** Device has been announced but is not in production. Samples may or may not be available.

**OBSOLETE:** TI has discontinued the production of the device.

(2) **RoHS:** TI defines "RoHS" to mean semiconductor products that are compliant with the current EU RoHS requirements for all 10 RoHS substances, including the requirement that RoHS substance do not exceed 0.1% by weight in homogeneous materials. Where designed to be soldered at high temperatures, "RoHS" products are suitable for use in specified lead-free processes. TI may reference these types of products as "Pb-Free".

**RoHS Exempt:** TI defines "RoHS Exempt" to mean products that contain lead but are compliant with EU RoHS pursuant to a specific EU RoHS exemption.

**Green:** TI defines "Green" to mean the content of Chlorine (Cl) and Bromine (Br) based flame retardants meet JS709B low halogen requirements of <=1000ppm threshold. Antimony trioxide based flame retardants must also meet the <=1000ppm threshold requirement.

(3) MSL, Peak Temp. - The Moisture Sensitivity Level rating according to the JEDEC industry standard classifications, and peak solder temperature.

(4) There may be additional marking, which relates to the logo, the lot trace code information, or the environmental category on the device.

(5) Multiple Device Markings will be inside parentheses. Only one Device Marking contained in parentheses and separated by a "-" will appear on a device. If a line is indented then it is a continuation of the previous line and the two combined represent the entire Device Marking for that device.

(6) Lead finish/Ball material - Orderable Devices may have multiple material finish options. Finish options are separated by a vertical ruled line. Lead finish/Ball material values may wrap to two lines if the finish value exceeds the maximum column width.

**Important Information and Disclaimer:** The information provided on this page represents TI's knowledge and belief as of the date that it is provided. TI bases its knowledge and belief on information provided by third parties, and makes no representation or warranty as to the accuracy of such information. Efforts are underway to better integrate information from third parties. TI has taken and continues to take reasonable steps to provide representative and accurate information but may not have conducted destructive testing or chemical analysis on incoming materials and chemicals. TI and TI suppliers consider certain information to be proprietary, and thus CAS numbers and other limited information may not be available for release.

In no event shall TI's liability arising out of such information exceed the total purchase price of the TI part(s) at issue in this document sold by TI to Customer on an annual basis.

## TAPE AND REEL INFORMATION



### QUADRANT ASSIGNMENTS FOR PIN 1 ORIENTATION IN TAPE



\*All dimensions are nominal

Device	Package Type	Package Drawing	Pins	SPQ	Reel Diameter (mm)	Reel Width W1 (mm)	A0 (mm)	B0 (mm)	K0 (mm)	P1 (mm)	W (mm)	Pin1 Quadrant
LMH9126IRRLR	WQFN	RRL	12	3000	180.0	8.4	2.2	2.2	1.2	4.0	8.0	Q2

TAPE AND REEL BOX DIMENSIONS



\*All dimensions are nominal

Device	Package Type	Package Drawing	Pins	SPQ	Length (mm)	Width (mm)	Height (mm)
LMH9126IRRLR	WQFN	RRL	12	3000	213.0	191.0	35.0

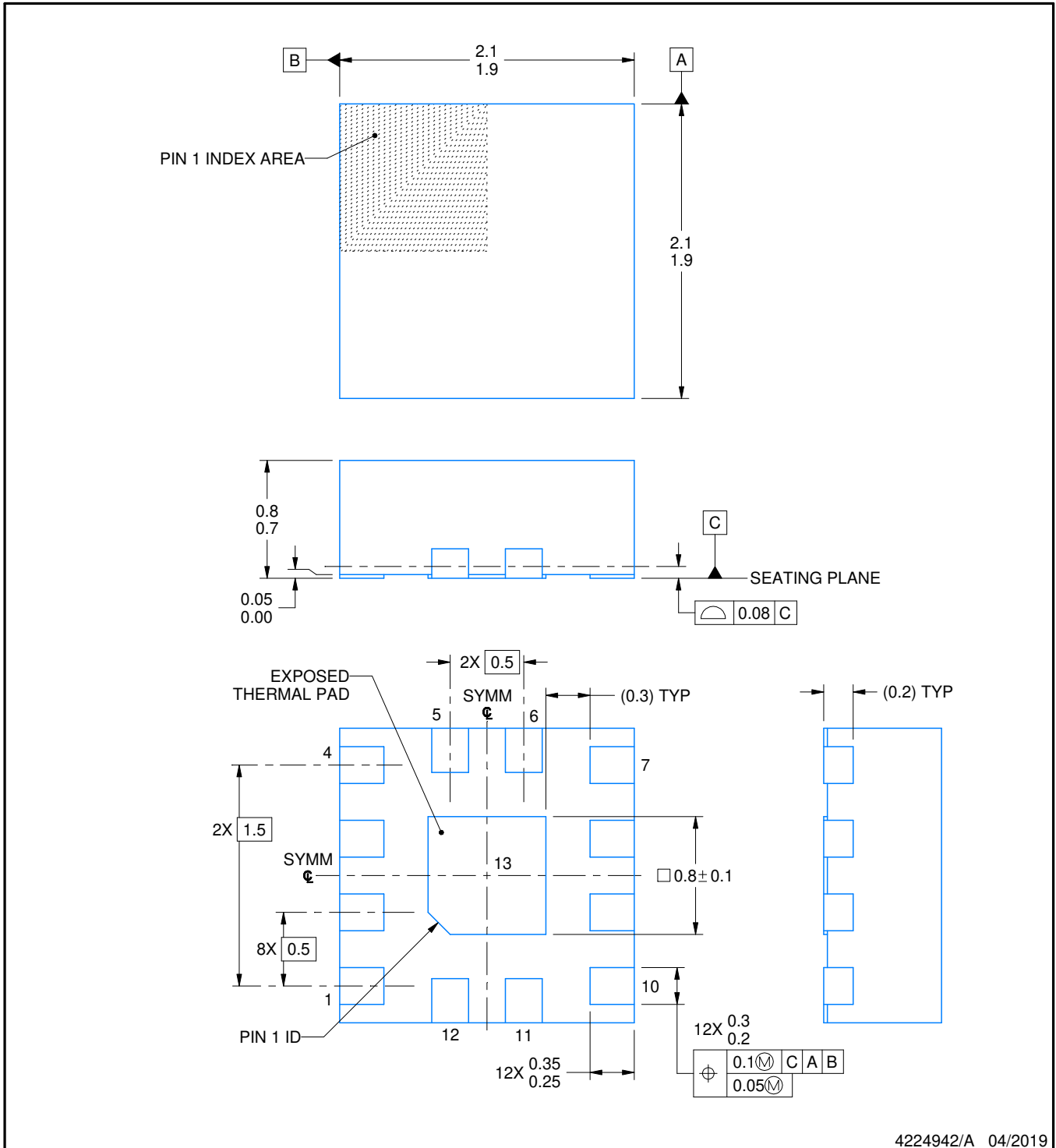
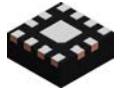

4224942/A 04/2019

NOTES:

1. All linear dimensions are in millimeters. Any dimensions in parenthesis are for reference only. Dimensioning and tolerancing per ASME Y14.5M.
2. This drawing is subject to change without notice.
3. The package thermal pad must be soldered to the printed circuit board for thermal and mechanical performance.

# EXAMPLE BOARD LAYOUT

## RRL0012A

## WQFN - 0.8 mm max height

PLASTIC QUAD FLATPACK - NO LEAD

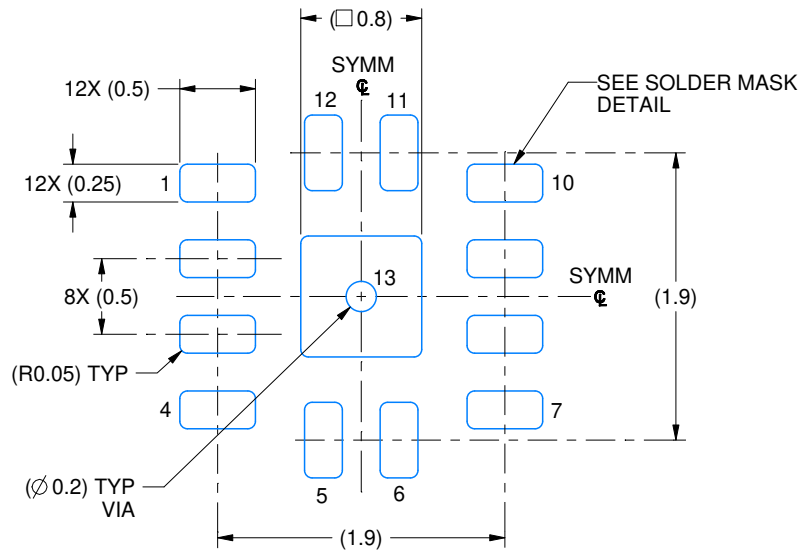

**LAND PATTERN EXAMPLE**  
EXPOSED METAL SHOWN  
SCALE: 20X

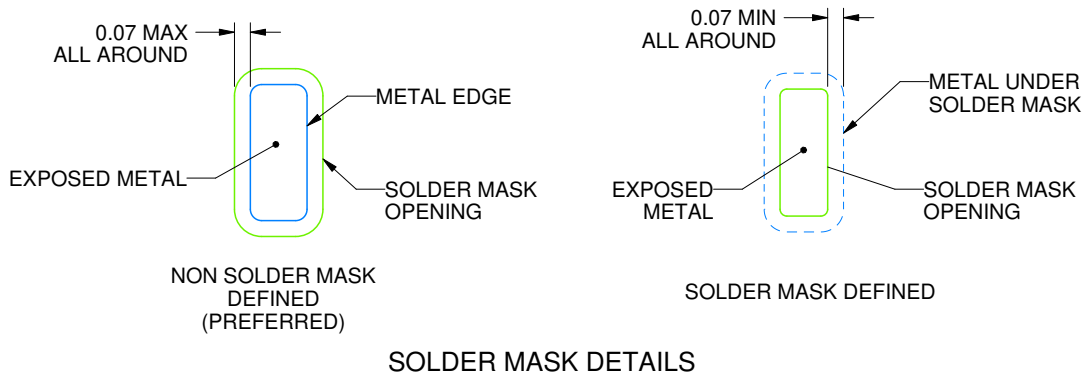

4224942/A 04/2019

NOTES: (continued)

- This package is designed to be soldered to a thermal pad on the board. For more information, see Texas Instruments literature number SLUA271 ([www.ti.com/lit/slue271](http://www.ti.com/lit/slue271)).
- Vias are optional depending on application, refer to device data sheet. If any vias are implemented, refer to their locations shown on this view. It is recommended that vias under paste be filled, plugged or tented.

# EXAMPLE STENCIL DESIGN

RRL0012A

WQFN - 0.8 mm max height

PLASTIC QUAD FLATPACK - NO LEAD

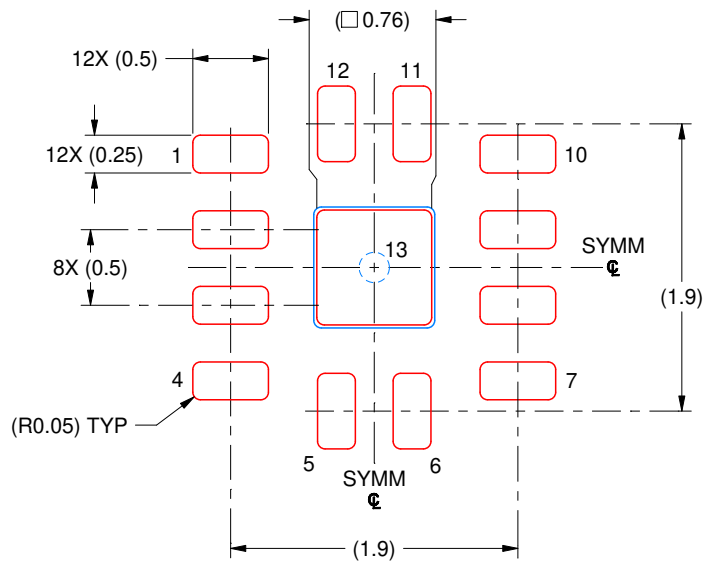

SOLDER PASTE EXAMPLE  
BASED ON 0.125 MM THICK STENCIL  
SCALE: 20X

EXPOSED PAD 13  
90% PRINTED SOLDER COVERAGE BY AREA UNDER PACKAGE

4224942/A 04/2019

NOTES: (continued)

6. Laser cutting apertures with trapezoidal walls and rounded corners may offer better paste release. IPC-7525 may have alternate design recommendations.

## IMPORTANT NOTICE AND DISCLAIMER

TI PROVIDES TECHNICAL AND RELIABILITY DATA (INCLUDING DATASHEETS), DESIGN RESOURCES (INCLUDING REFERENCE DESIGNS), APPLICATION OR OTHER DESIGN ADVICE, WEB TOOLS, SAFETY INFORMATION, AND OTHER RESOURCES "AS IS" AND WITH ALL FAULTS, AND DISCLAIMS ALL WARRANTIES, EXPRESS AND IMPLIED, INCLUDING WITHOUT LIMITATION ANY IMPLIED WARRANTIES OF MERCHANTABILITY, FITNESS FOR A PARTICULAR PURPOSE OR NON-INFRINGEMENT OF THIRD PARTY INTELLECTUAL PROPERTY RIGHTS.

These resources are intended for skilled developers designing with TI products. You are solely responsible for (1) selecting the appropriate TI products for your application, (2) designing, validating and testing your application, and (3) ensuring your application meets applicable standards, and any other safety, security, or other requirements. These resources are subject to change without notice. TI grants you permission to use these resources only for development of an application that uses the TI products described in the resource. Other reproduction and display of these resources is prohibited. No license is granted to any other TI intellectual property right or to any third party intellectual property right. TI disclaims responsibility for, and you will fully indemnify TI and its representatives against, any claims, damages, costs, losses, and liabilities arising out of your use of these resources.

TI's products are provided subject to TI's Terms of Sale (<https://www.ti.com/legal/termsofsale.html>) or other applicable terms available either on [ti.com](https://www.ti.com) or provided in conjunction with such TI products. TI's provision of these resources does not expand or otherwise alter TI's applicable warranties or warranty disclaimers for TI products.

Mailing Address: Texas Instruments, Post Office Box 655303, Dallas, Texas 75265  
Copyright © 2021, Texas Instruments Incorporated