



Designers' Choice

PLUGS & JACKS

SHROUDED MALE PIN JACKS & SPRING CONTACT PLUGS

- Fully shrouded connection
- Color coded for easy identification
- Low contact resistance
- Precision spring contact for reliable connection
- Highly durable for multiple insertions
- Plugs available for 20 and 22 gauge wire (crimp or solder)
- Low insertion and withdrawal forces
- Field replaceable and autoclavable



SPECIFICATIONS

Current Rating: 7 Amps
Breakdown Voltage: 3500 VRMS
Contact Resistance: .010 Ω Maximum
Plug Shroud Diameter: .177
Operating Temperature: -66 °F to +185° F (-55°C to +85°C)

SHROUDED MALE PIN JACK (Fully Insulated)

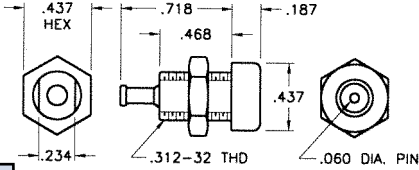

CAT. NO.	COLOR
9000	WHITE
9001	RED
9002	BLACK

MATERIAL
Male Pin: Brass, Gold Plate
Nut: Brass, Nickel Plate
Insulator: Polycarbonate

MATES WITH

SHROUDED SPRING CONTACT PLUG

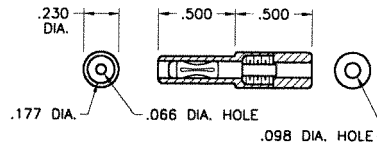

MATERIAL
Spring Contact: Beryllium Copper, Gold Plate
Body: Brass, Gold Plate
Insulator: Polycarbonate

CAT. NO.	COLOR	GAUGE
9006	WHITE	20 AWG WIRE
9007	RED	
9008	BLACK	
9012	WHITE	22 AWG WIRE
9013	RED	
9014	BLACK	

FULLY-INSULATED DELUXE TIP JACK

ACCEPTS .080" TIP (WITH CLOSED ENTRY CONTACT)

Fully molded body with recessed closed entry design. Assures maximum retention with .010Ω maximum contact resistance. Prevents accidental insertion of larger diameter probes. Current rating: 10 Amps. Breakdown voltage 5700 VRMS. Capacitance to metal panel 2.0 pF nominal. Supplied with nut.

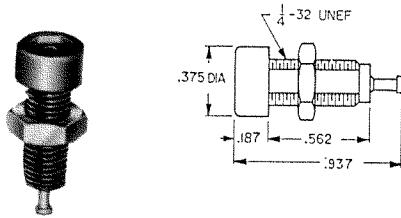

MATERIAL
Body: Molded Nylon ASTM D4066
Contact: Beryllium Copper, Silver Plate
Terminal: Brass, Tin Plate

SELECTION OF COLORS

CAT. NO.	COLOR
6030	WHITE
6031	RED
6032	BLACK
6033	GREEN
6034	YELLOW
6035	BLUE

FULLY-INSULATED STANDARD TIP JACK

ACCEPTS .080" TIP

Economical tip jacks with molded Nylon body. Low contact resistance. Formed phosphor bronze contact with solder hole for ease in attaching wire. Current rating 10 Amps. Breakdown voltage 5700 VRMS. Capacitance to metal panel 3.8 pF. Supplied with nut.

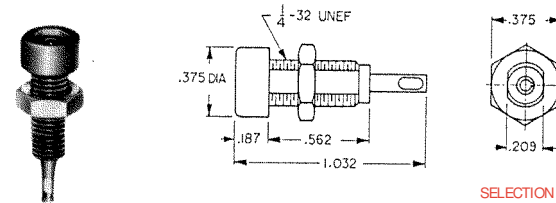

MATERIAL
Body: Molded Nylon ASTM D4066
Contact: Phosphor Bronze, Tin Plate

SELECTION OF COLORS

CAT. NO.	COLOR
6018	WHITE
6019	RED
6020	BLACK
6021	GREEN
6022	YELLOW
6023	BLUE

METAL-CLAD TIP JACK (MIL)

ACCEPTS .080" TIP (WITH CLOSED ENTRY CONTACT)

High quality tip jack for high reliability industrial applications. Ideal for use where required to withstand severe environmental conditions, temperature, vibration and salt spray. Recessed closed entry contact. Current rating: 5 Amps. Breakdown voltage: 5700 VRMS. Made to MS-16108 Rev. F of MIL-STD-242A and MIL-C39024/10. Capacitance to metal panel 2.0 pF. Supplied complete with hardware.

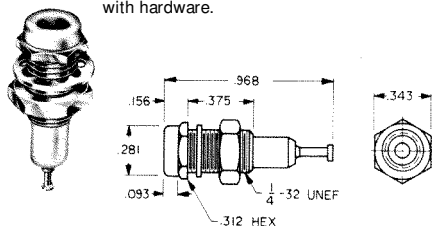

MATERIAL
Body: Molded Nylon ASTM D4066
Shell & Nut: Brass QQ-B-626 Nickel Plate QQ-N-290
Contact: Beryllium Copper PER QQ-C-533. Gold Plate MIL-G-45204

SELECTION OF COLORS

CAT. NO.	COLORS
6012	WHITE
6013	RED
6014	BLACK
6015	GREEN
6016	YELLOW
6017	BLUE

METAL-CLAD TIP JACK (STD)

ACCEPTS .080" TIP

Molded Nylon body with metal jacket. Contact is formed from phosphor bronze with solder hole for ease in attaching wire. Designed for positive contact, easy insertion and withdrawal. Current rating: 10 Amps. Breakdown voltage: 5700VRMS. Capacitance to metal panel 3.8 pF. Supplied with nut.

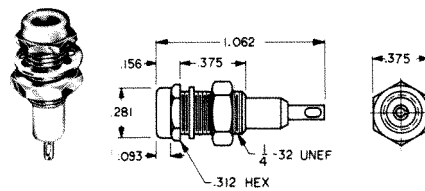

MATERIAL
Body: Molded Nylon ASTM D4066
Shell: Brass, Nickel Plate
Contact: Phosphor, Bronze Silver Plate

SELECTION OF COLORS

CAT. NO.	COLOR
6024	WHITE
6025	RED
6026	BLACK
6027	GREEN
6028	YELLOW
6029	BLUE

UNINSULATED TIP JACK

ACCEPTS .080" TIP

Quality, precision machined tip jack made of brass. Ideal for use on metal panels where grounding is required. Fits panels up to 3/8" thk. Complete with hex nut.

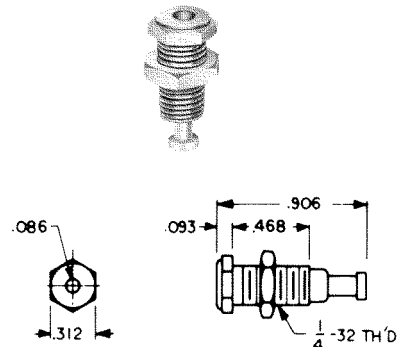

MATERIAL
Body: Brass, Nickel Plate
Contact: Beryllium Copper
Rating: 15 Amps.

CAT. NO. 6097