

FP1 110V

High frequency, high current power inductors



Product features

- Vertical design utilizes less board space
- Tight tolerance DCR for sensing circuits
- Inductance Range from 150 nH to 320 nH
- Current range from 42 A to 90 A
- 10.7 mm x 7.5 mm and 10.5 mm x 6.2 mm footprint surface mount package in a 9.5 mm height
- Ferrite core material
- Moisture sensitivity level (MSL): 1

Applications

- Multi-phase and Vcore regulators
- Voltage Regulator Modules (VRMs)
 - Server and desktop
 - Central processing unit (CPU)
 - Graphics processing unit (GPU))
 - Application specific integrated circuit (ASIC)
 - High power density
- Data networking and storage systems
- Graphics cards and battery power systems
- Portable electronics
- Point-of-load modules
- DCR sensing circuits

Environmental compliance and general specifications

- Storage temperature range (Component): -40 °C to +125 °C
- Operating temperature range: -40 °C to +125 °C (ambient plus self-temperature rise)
- Solder reflow temperature: J-STD-020 (latest revision) compliant



Product specifications

Part number ⁷	OCL ¹ (nH) ±10%	FLL ² (nH) minimum	I _{rms} ³ (A)	I _{sat1} ⁴ (A)	I _{sat2} ⁵ (A)	DCR (mΩ) ±5% @ +20°C	K-factor ⁶
V1 version							
FP1110V1-R15-R	150	108	61	90	72	0.23	278
FP1110V1-R20-R	195	140	61	70	58	0.23	278
FP1110V1-R22-R	220	158	61	64	51	0.23	278
FP1110V1-R27-R	270	173	61	55	44	0.23	278
FP1110V1-R32-R	320	230	61	42	34	0.23	278
V2 version							
FP1110V2-R150-R	150	108	61	89	70	0.18	328
FP1110V2-R180-R	180	130	61	72	57.5	0.18	328
FP1110V2-R200-R	200	144	61	65	52	0.18	328
FP1110V2-R220-R	220	159	61	59	47	0.18	328
FP1110V2-R270-R	270	195	61	48	38.5	0.18	328
FP1110V2-R320-R	320	230	61	40.5	32.5	0.18	328

1. Open circuit inductance (OCL) Test parameters: 100 kHz, 0.1 Vrms, 0.0 Adc, +25 °C

2. Full load inductance (FLL) Test parameters: 100 kHz, 0.1 Vrms, @ I_{sat1}, @ +25 °C

3. I_{rms}: DC current for an approximate temperature rise of 40 °C without core loss. Derating is necessary for AC currents. PCB layout, trace thickness and width, air-flow, and proximity of other heat generating components will affect the temperature rise. It is recommended that the temperature of the part not exceed +125 °C under worst case operating conditions verified in the end application.

4. I_{sat1}: Peak current for approximately 20% rolloff @ +25 °C

5. I_{sat}: Peak current for approximately 20% rolloff @ +100 °C

6. K-factor: Used to determine B_{pp} for core loss (see graph). B_{pp} = K * L * ΔI * 10³.

B_{pp}: (Gauss), K: (K-factor from table), L: (Inductance in nH), ΔI (Peak to peak ripple current in Amps).

7. Part Number Definition: FP1110Vx-Rxx(x)-R

FP1110V = Product code

x= Version indicator

Rxx(x)= Inductance value in uH, R= decimal point

-R suffix = RoHS compliant

Dimensions- mm

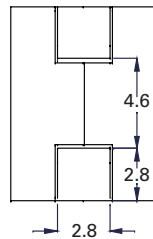
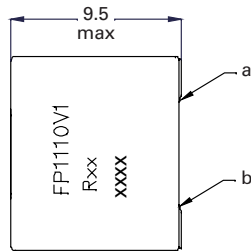
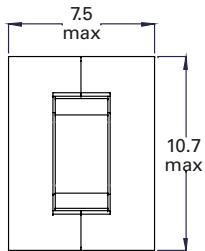

Recommended pad layout

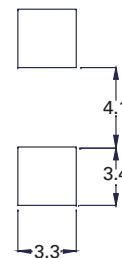

Schematic

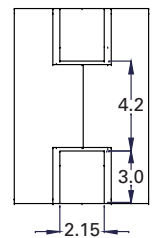
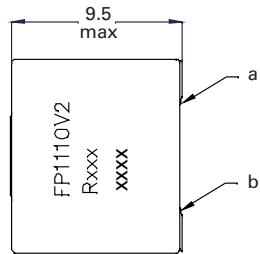
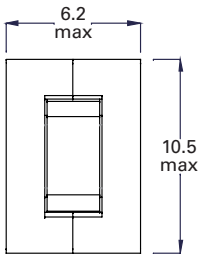
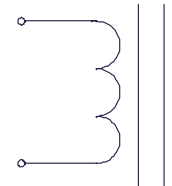

Recommended pad layout

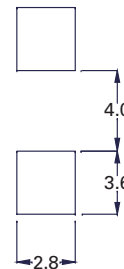

Schematic

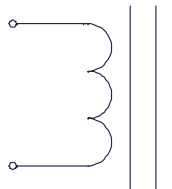

Part marking: FP1110Vx (x=Version indicator), Rxx(x)=inductance value in μH, R=decimal point

xxxx= lot code

DCR measured from point "a" to point "b"

Soldering surfaces to be coplanar within 0.10 millimeters

Traces or vias underneath the inductor is not recommended.

Packaging information- mm

(Drawing not to scale)

(Supplied in tape and reel packaging, 300 parts per 13" diameter reel)

FP1110V1

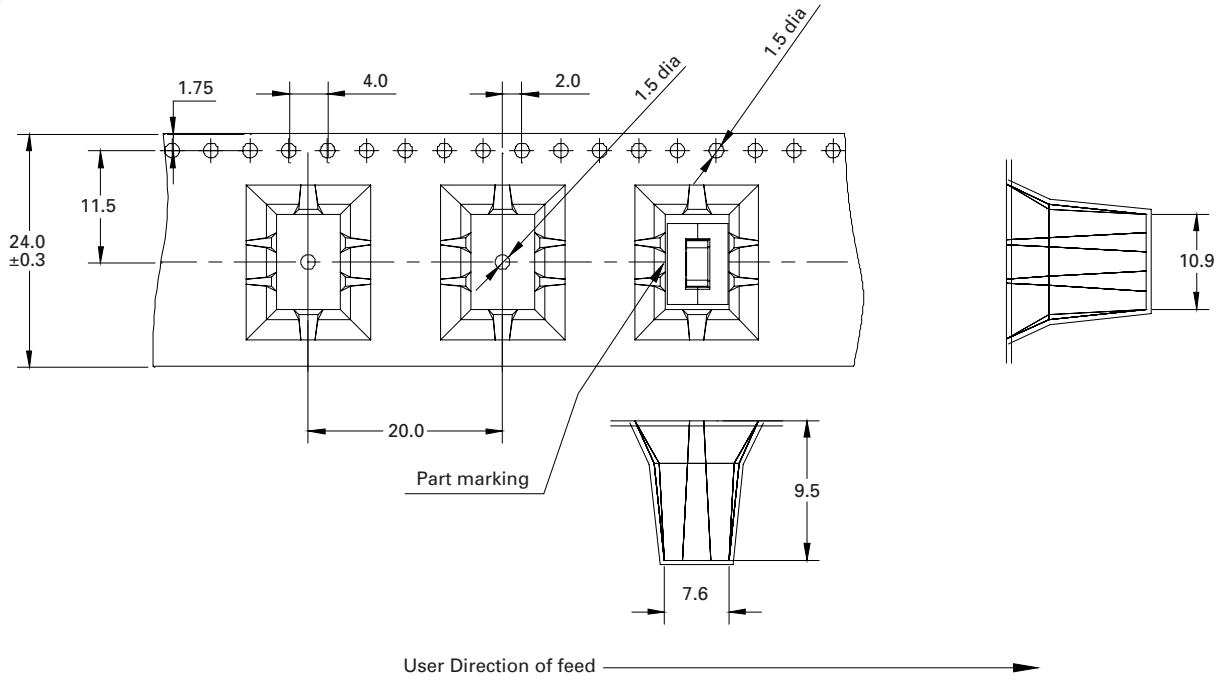

FP1110V2

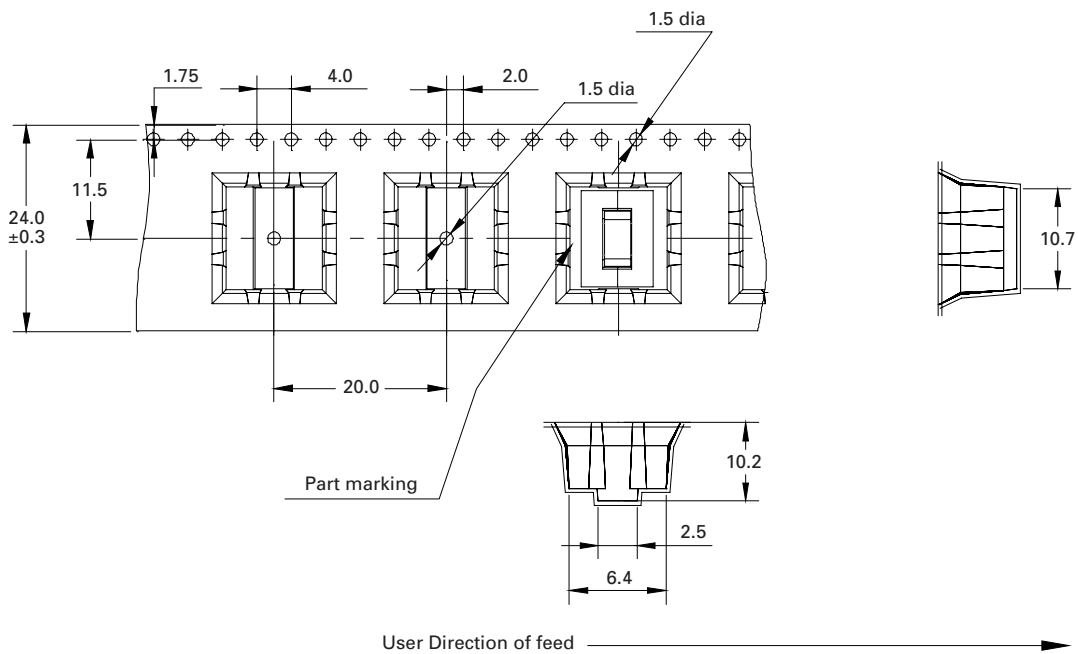

Temperature rise vs. total loss

FP1110V1

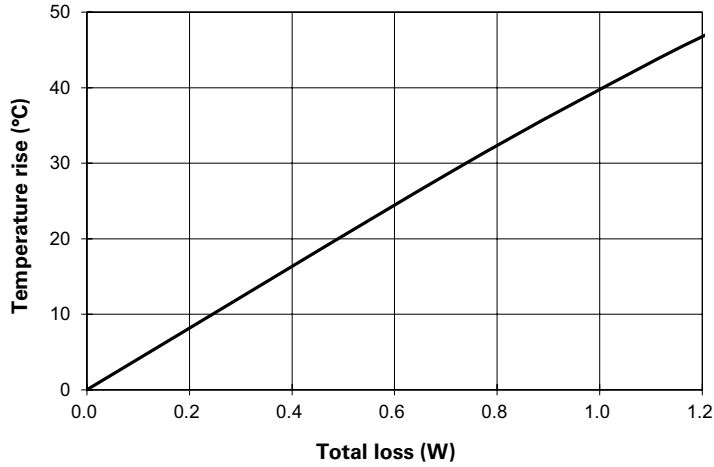

FP1110V2

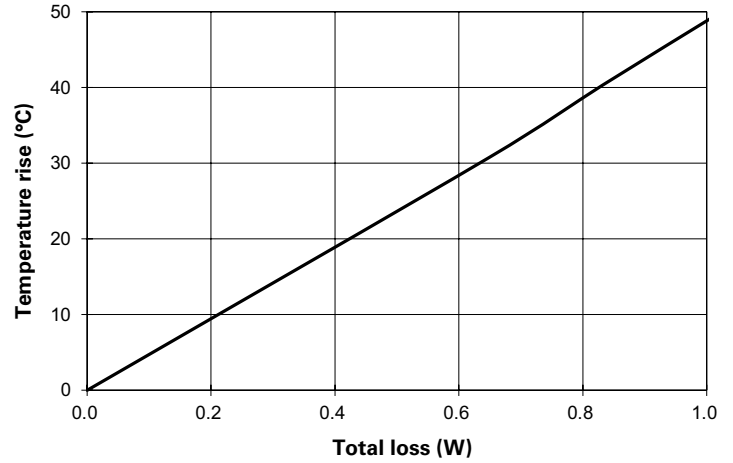

Core loss vs. B_{p-p}

FP1110V1

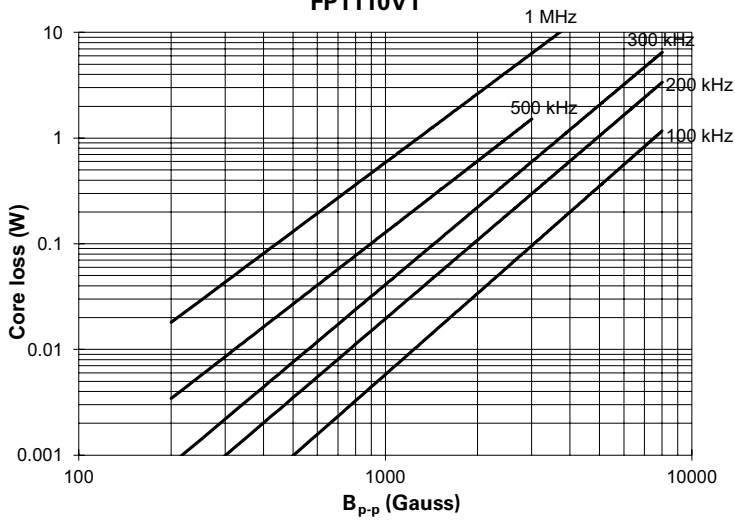

FP1110V2

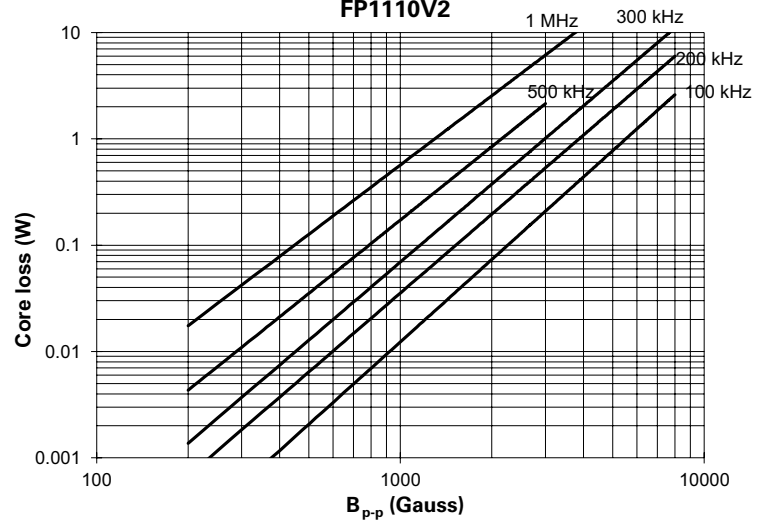

Inductance characteristics

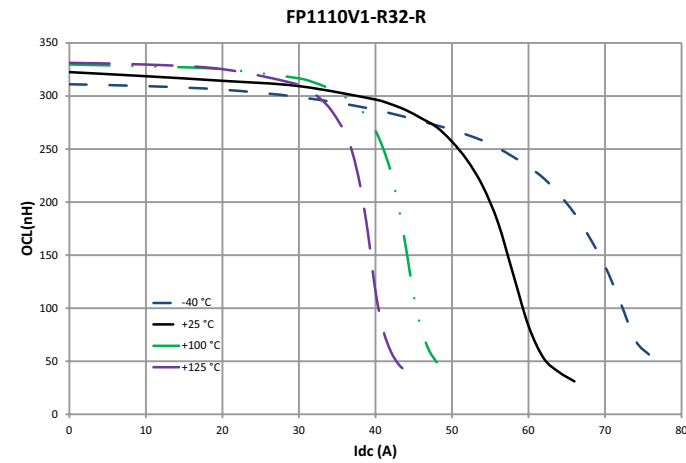
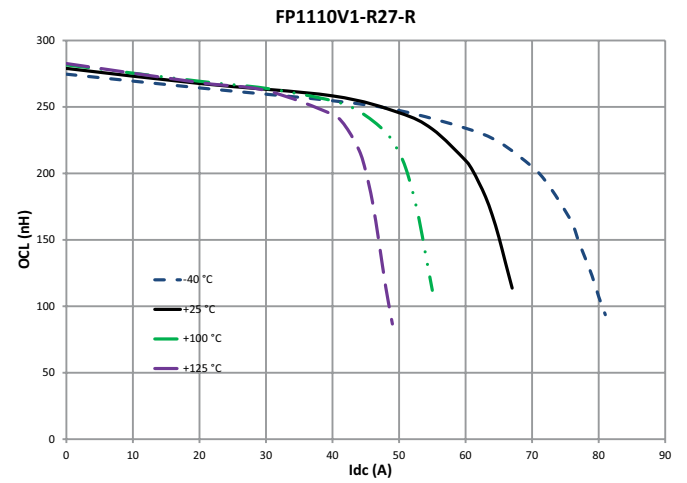
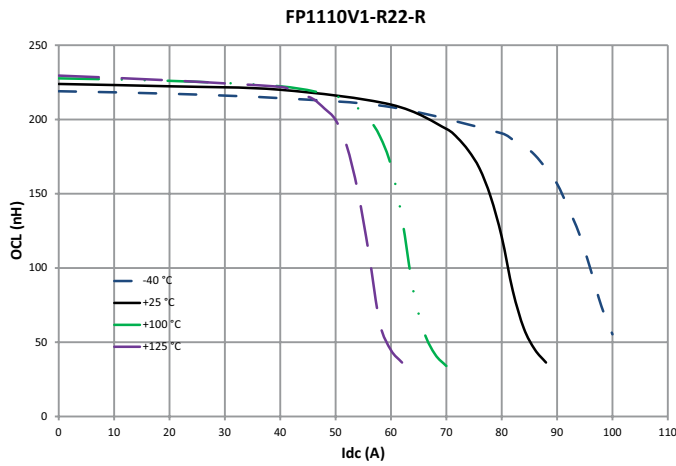
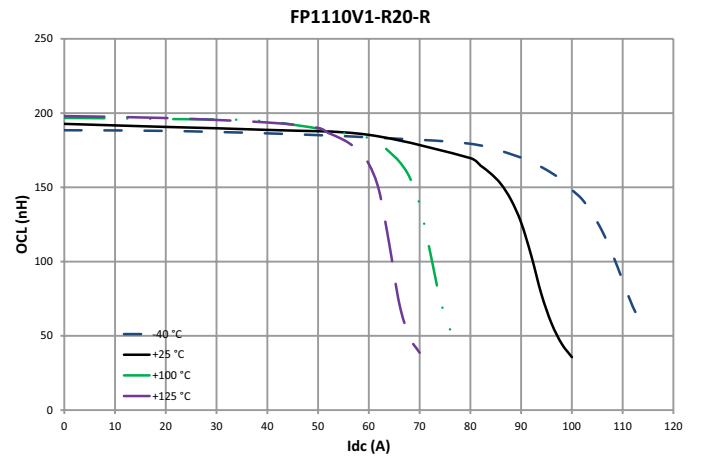
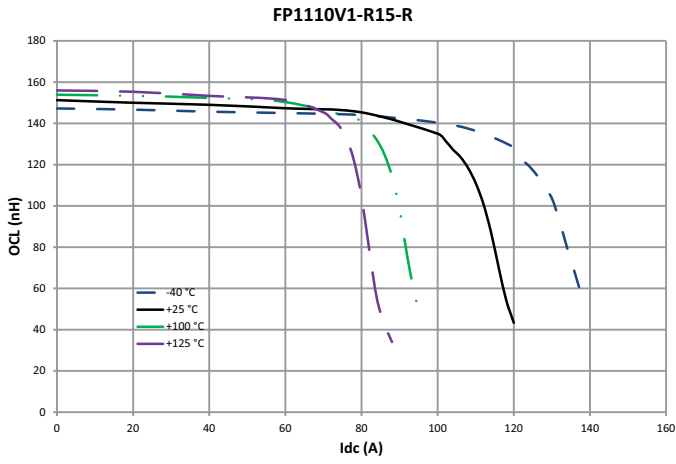

Inductance characteristics

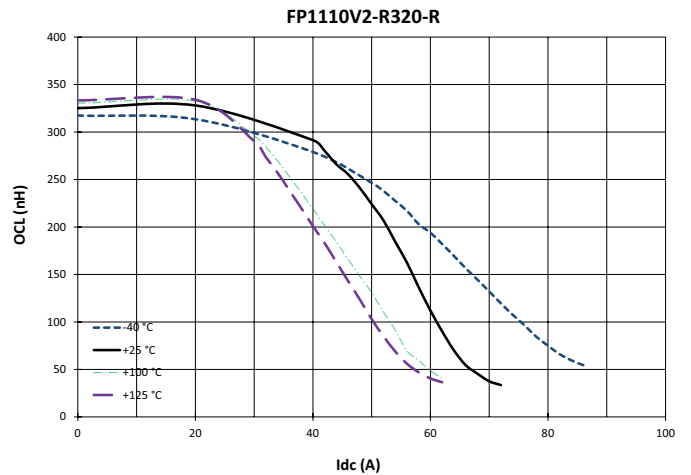
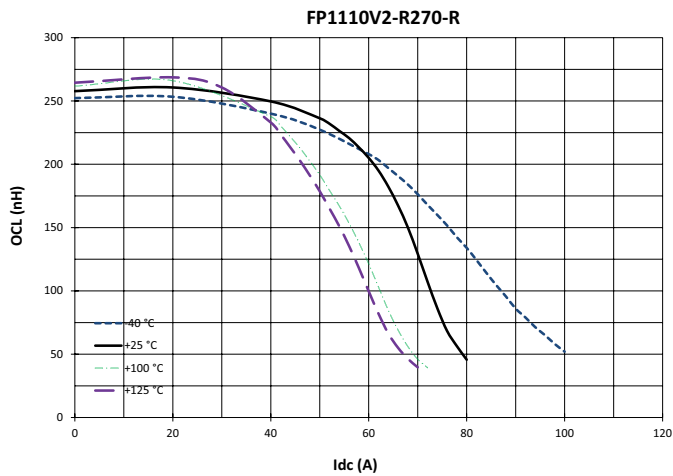
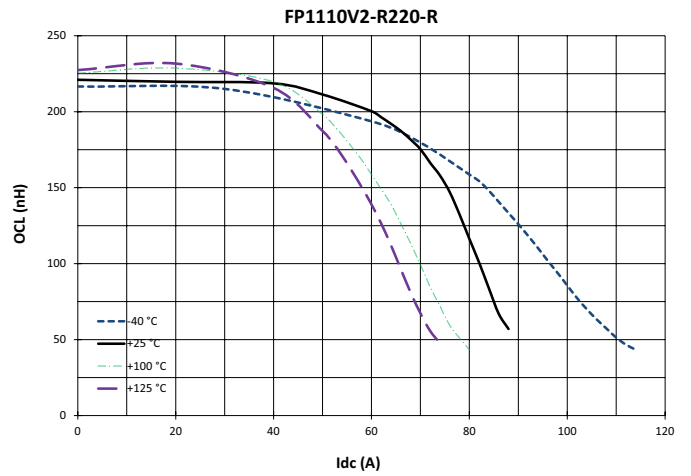
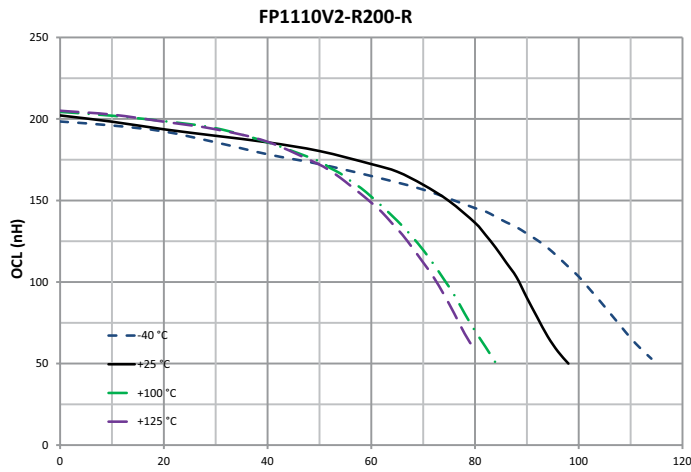
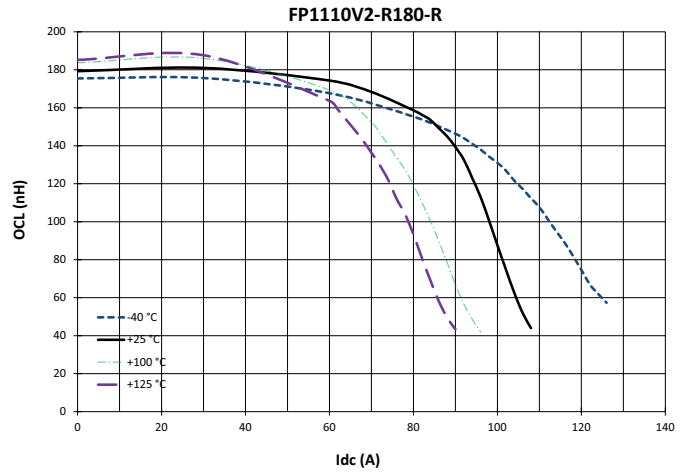
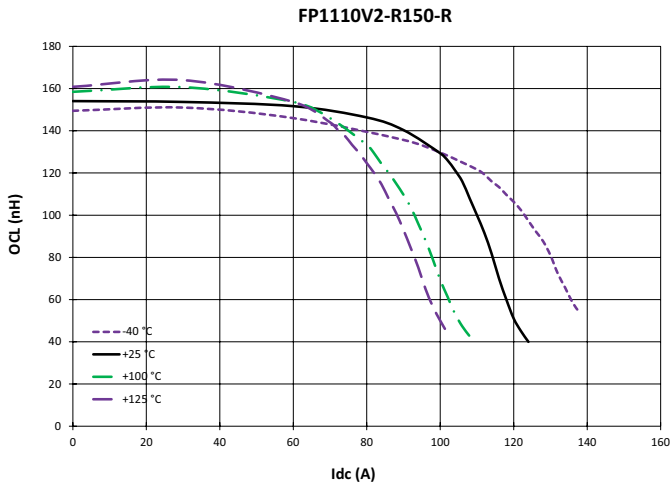

Solder reflow profile

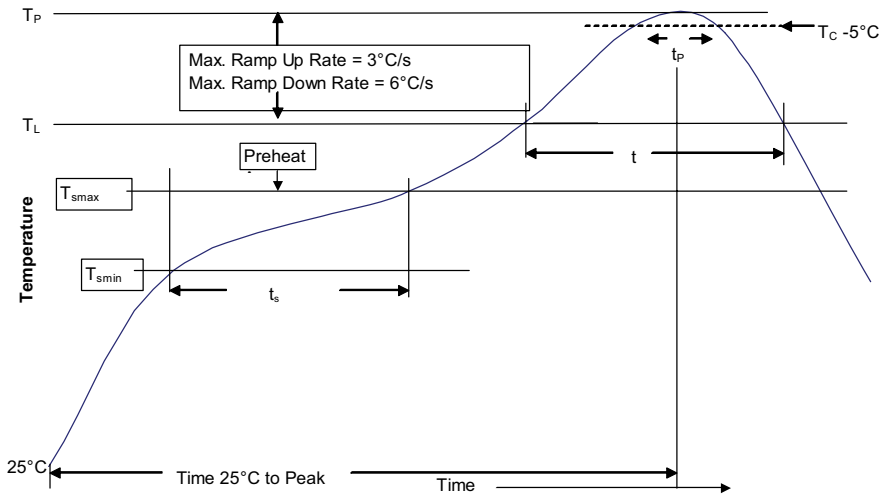

Table 1 - Standard SnPb solder (T_C)

Package thickness	Volume mm ³ <350	Volume mm ³ ≥350
<2.5 mm	235 °C	220 °C
≥2.5 mm	220 °C	220 °C

Table 2 - Lead (Pb) free solder (T_C)

Package thickness	Volume mm ³ <350	Volume mm ³ 350 - 2000	Volume mm ³ >2000
<1.6 mm	260 °C	260 °C	260 °C
1.6 – 2.5 mm	260 °C	250 °C	245 °C
>2.5 mm	250 °C	245 °C	245 °C

Reference J-STD-020

Profile feature	Standard SnPb solder	Lead (Pb) free solder
Preheat and soak		
• Temperature min. (T _{smin})	100 °C	150 °C
• Temperature max. (T _{smax})	150 °C	200 °C
• Time (T _{smin} to T _{smax}) (t _s)	60-120 seconds	60-120 seconds
Ramp up rate T _L to T _p	3 °C/ second max.	3 °C/ second max.
Liquidous temperature (T _L)	183 °C	217 °C
Time (t _L) maintained above T _L	60-150 seconds	60-150 seconds
Peak package body temperature (T _p)*	Table 1	Table 2
Time (t _p)* within 5 °C of the specified classification temperature (T _C)	20 seconds*	30 seconds*
Ramp-down rate (T _p to T _L)	6 °C/ second max.	6 °C/ second max.
Time 25 °C to peak temperature	6 minutes max.	8 minutes max.

* Tolerance for peak profile temperature (T_p) is defined as a supplier minimum and a user maximum.

Life Support Policy: Eaton does not authorize the use of any of its products for use in life support devices or systems without the express written approval of an officer of the Company. Life support systems are devices which support or sustain life, and whose failure to perform, when properly used in accordance with instructions for use provided in the labeling, can be reasonably expected to result in significant injury to the user.

Eaton reserves the right, without notice, to change design or construction of any products and to discontinue or limit distribution of any products. Eaton also reserves the right to change or update, without notice, any technical information contained in this bulletin.

Eaton
Electronics Division
1000 Eaton Boulevard
Cleveland, OH 44122
United States
Eaton.com/electronics

© 2020 Eaton
All Rights Reserved
Printed in USA
Publication No. 10427
June 2020

Eaton is a registered trademark.

All other trademarks are property of their respective owners.

Follow us on social media to get the latest product and support information.

