

KGG-MC 1,5/16

Order No.: 1834482



<http://eshop.phoenixcontact.de/phoenix/treeViewClick.do?UID=1834482>

Cable housing, Pitch: 3.81 mm, Number of positions: 16, Dimension a: 63.35 mm, Color: green

Commercial data	
EAN	4017918051938
Pack	10 pcs.
Customs tariff	85472000
Weight/Piece	0.0137 KG
Catalog page information	Page 191 (CC-2009)

Product notes

WEEE/RoHS-compliant since: 01/01/2003



<http://www.download.phoenixcontact.com>
Please note that the data given here has been taken from the online catalog. For comprehensive information and data, please refer to the user documentation. The General Terms and Conditions of Use apply to Internet downloads.

Accessories

Item	Designation	Description
Marking		
1839050	KGG-MC 1,5/ DST	Transparent label carrier, can be marked with marker strips SBS 10
1007248	SBS10:UNBEDRUCKT	Marker cards, unprinted, for individual labeling with the M-PEN, 250-section, perforated, white plastic

Diagrams/Drawings

Dimensioned drawing

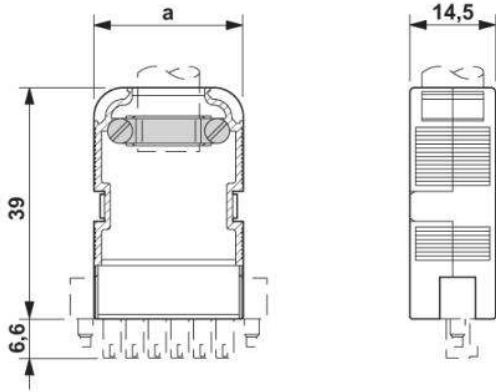

Address

PHOENIX CONTACT Deutschland GmbH
Flachmarktstr. 8
32825 Blomberg, Germany
Phone +49 5235 3 12000
Fax +49 5235 3 41200
<http://www.phoenixcontact.de>



© 2010 Phoenix Contact
Technical modifications reserved;