

DESCRIPTION

The EV28160-C-00A is an evaluation board for MP28160, which is an integrated Buck-Boost converter in small CSP package. The Buck-Boost converter can operate from an input voltage above, equal to, or below the output voltage. It uses current-mode control with 1.8MHz fixed PWM frequency to optimize stability and transient response. In light load condition, it enter auto PFM/PWM mode to get high light load efficiency. Integrated MOSFETs minimize the solution size while maintaining high efficiency.

Fault protection includes output hiccup current limiting, OVP and thermal shutdown.

The MP28160 is available in a tiny CSP-12 (1.4mmx1.8mm) package.

ELECTRICAL SPECIFICATION

Parameter	Symbol	Value	Units
Input Voltage	VIN	2.5 – 5.5	V
Output Voltage	VOU	3.3	V
Output Current	IOUT	0.5	A

FEATURES

- 2.5V to 5.5V Input-Voltage Range
- 1.8MHz Switching Frequency for CCM
- 3.3V Fixed Output Voltage
- 500mA Continuous Output Current
- 1ms Soft-start Time
- Auto PFM/PWM Mode
- Output over Voltage Protection
- Hiccup over Current Protection
- 1µA Shutdown Current
- Active Low System EN pin
- Over Temperature Shutdown
- Available in a Wafer Level Chip Scale Packaging: CSP-12(1.4mmx1.8mm)

APPLICATIONS

- USB-C Cable
- Thunderbolt
- Portable Devices

All MPS parts are lead-free, halogen-free, and adhere to the RoHS directive. For MPS green status, please visit the MPS website under Quality Assurance. "MPS" and "The Future of Analog IC Technology" are registered trademarks of Monolithic Power Systems, Inc.

EV28160-C-00A EVALUATION BOARD



**Total solution size
(L x W) 6.9mm x 7.2mm**

Board Number	MPS IC Number
EV28160-C-00A	MP28160GC

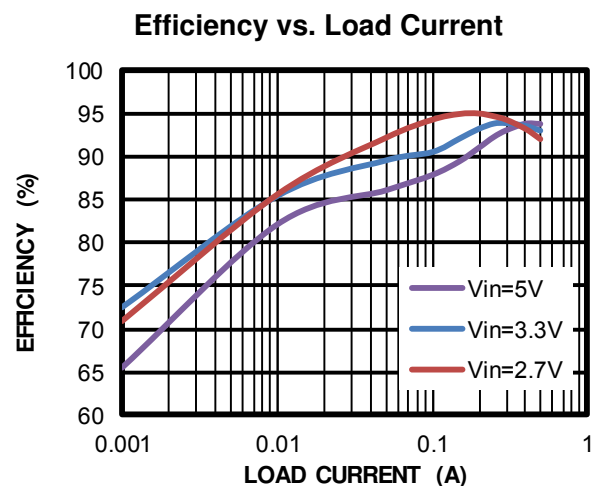

EVALUATION BOARD SCHEMATIC

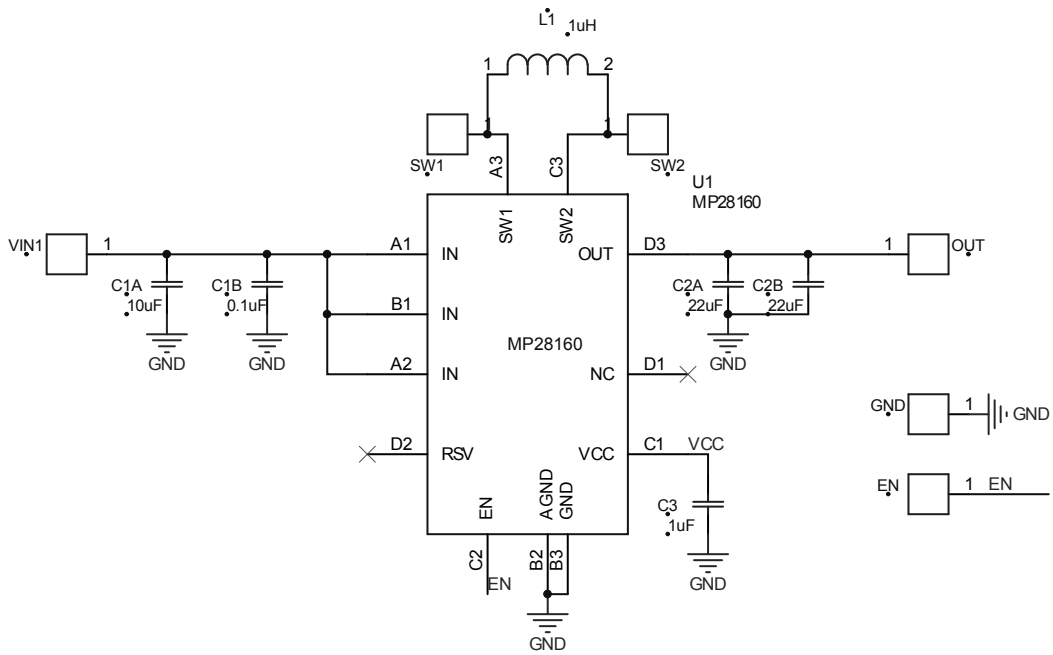

EV28160-C-00A BILL OF MATERIALS

RefDes	Value	Description	Package	Manufacturer	Manufacturer_P/N
C1A,	10 μ F	Ceramic Cap.,6.3V,X5R	0402	Murata	GRM155R60J106ME44D
C1B	0.1 μ F	Ceramic Cap.,16V,X5R	0402	Murata	GRM155R61C104KA88J
C2A, C2B	22 μ F	Ceramic Cap.,6.3V,X6S	0603	Murata	GRT188C80J226ME13D
C3	1 μ F	Ceramic Cap.,10V,X5R	0402	WE	885012105012
L1	1 μ H	1 μ H inductor	SMT	Murata	DFE252012P-1R0M=P2
U1	MP28160	CSP-12, buck-boost DC-DC converter	CSP-12	MPS	MP28160GC
GNDSENSE, STATUS, SEL,SW1,SW2,EN	1PIN	1Pin single row straight Header	DIP	WE	61300111121
GND*3,VIN1,VIN2, OUT,OR_OUT	ϕ 2.0	ϕ 2.0 copper pin	DIP	N/A	ϕ 2.0 copper pin

EVB TEST RESULTS

Performance curves and waveforms are tested on the evaluation board.

$V_{IN} = 5V$, $V_{OUT} = 3.3V$, $L = 1\mu H$, $T_A = 25^\circ C$, unless otherwise noted.

Output Ripple

$V_{IN}=5V$, $V_{OUT}=3.3V$, $I_{OUT}=0A$

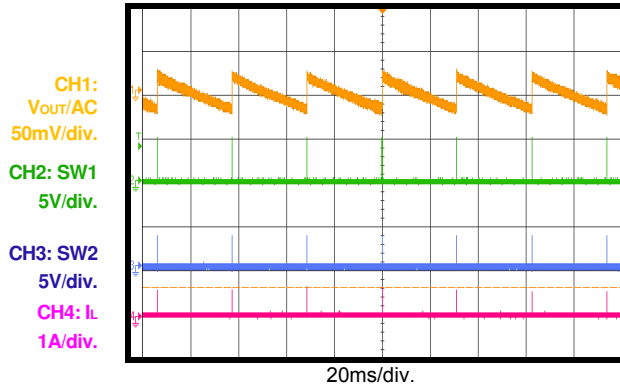

Output Ripple

$V_{IN}=5V$, $V_{OUT}=3.3V$, $I_{OUT}=0A$

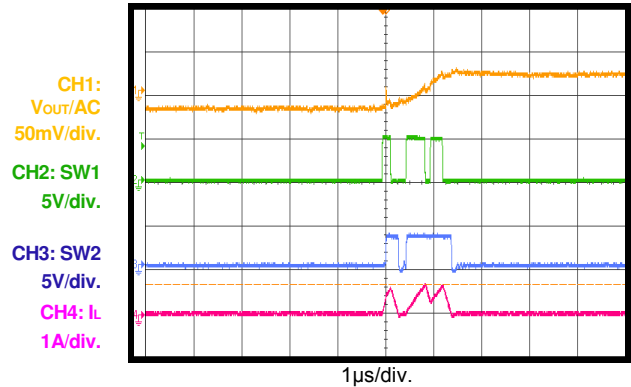

Output Ripple

$V_{IN}=5V$, $V_{OUT}=3.3V$, $I_{OUT}=0.5A$

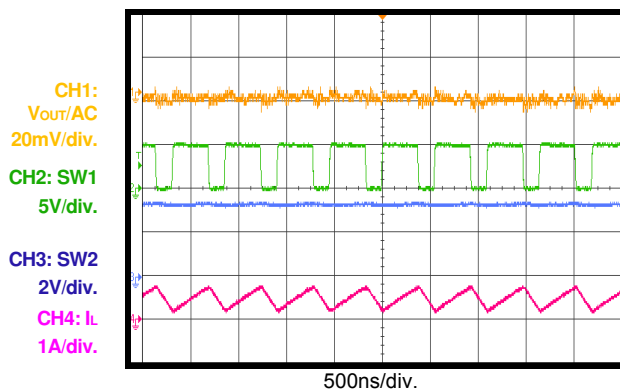

Output Ripple

$V_{IN}=3.3V$, $V_{OUT}=3.3V$, $I_{OUT}=0.5A$, Buck-boost mode

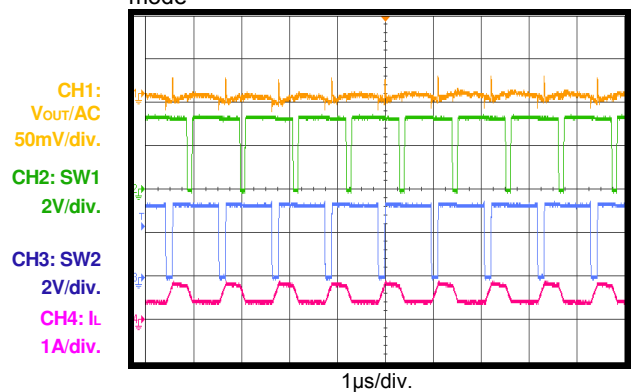

Output Ripple

$V_{IN}=2.5V$, $V_{OUT}=3.3V$, $I_{OUT}=0.5A$, Boost mode

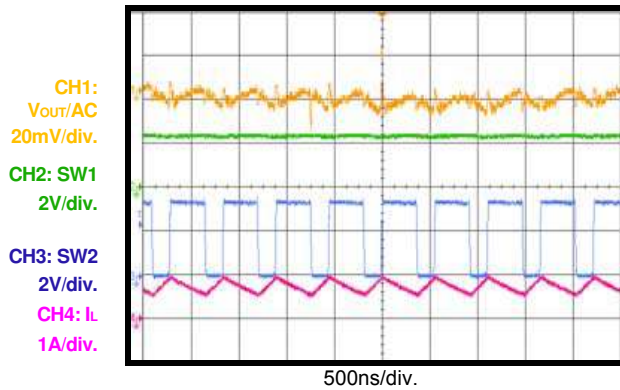

Power Start-Up

$V_{IN}=5V$, $V_{OUT}=3.3V$, $I_{OUT}=0A$

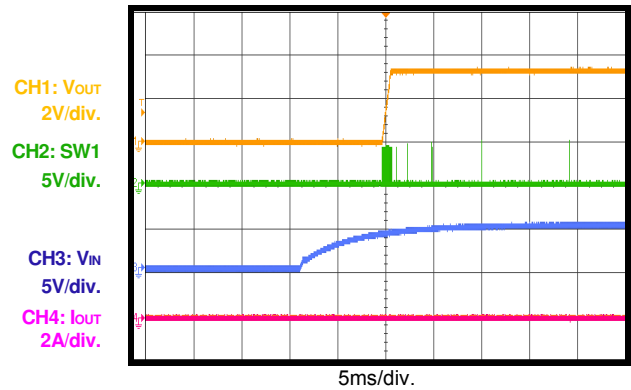

EVB TEST RESULTS (continued)

Performance curves and waveforms are tested on the evaluation board.

 $V_{IN} = 5V$, $V_{OUT} = 3.3V$, $L = 1\mu H$, $T_A = 25^\circ C$, unless otherwise noted.

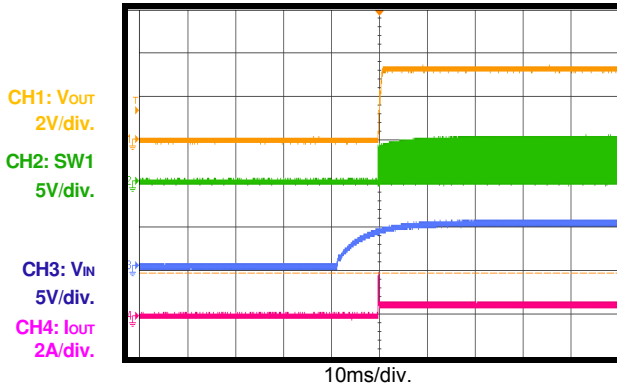
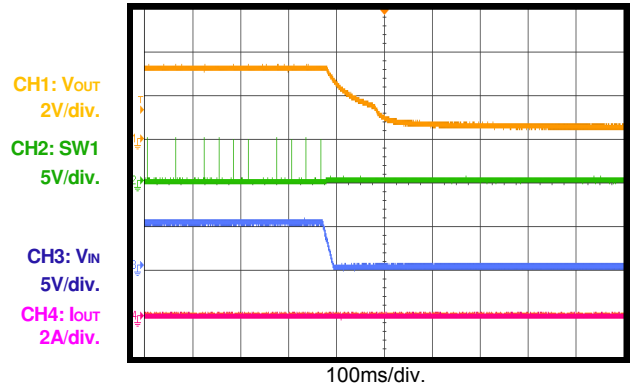
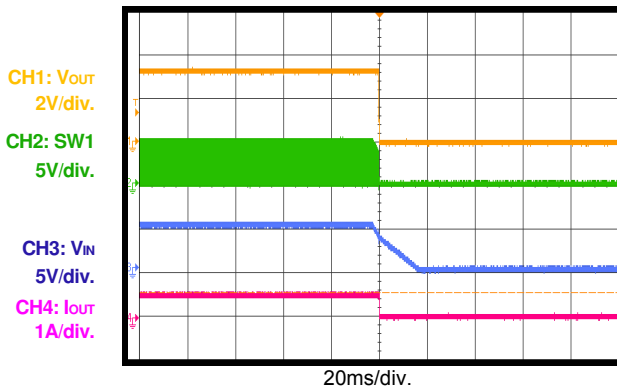
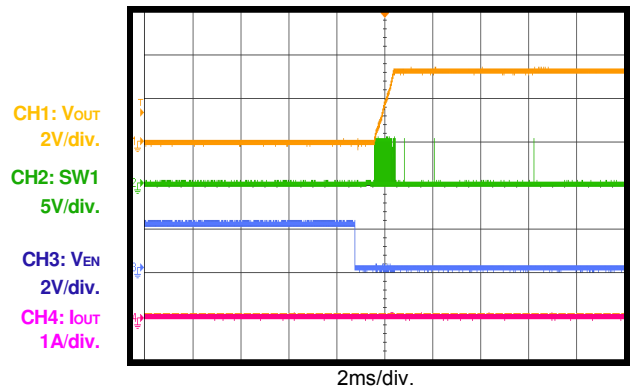
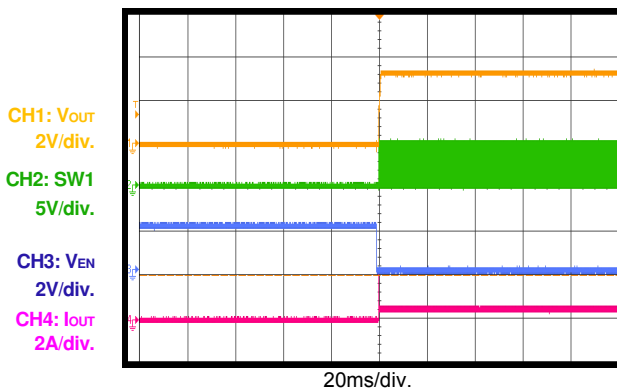
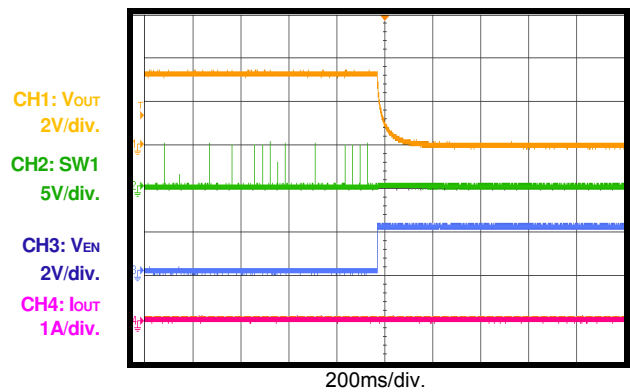
Power Start-Up
 $V_{IN}=5V$, $V_{OUT}=3.3V$, $I_{OUT}=0.5A$

Power Shutdown
 $V_{IN}=5V$, $V_{OUT}=3.3V$, $I_{OUT}=0A$

Power Shutdown
 $V_{IN}=5V$, $V_{OUT}=3.3V$, $I_{OUT}=0.5A$

EN Start-Up
 $V_{IN}=5V$, $V_{OUT}=3.3V$, $I_{OUT}=0A$

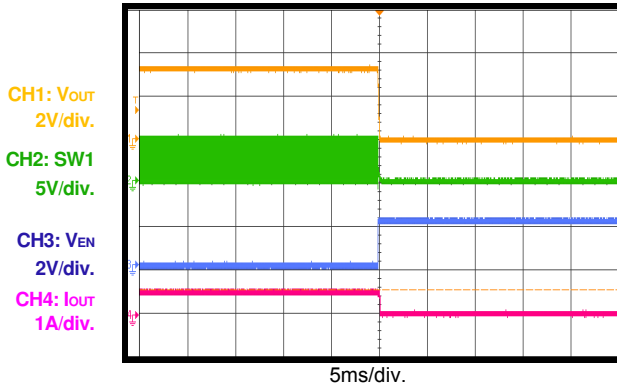
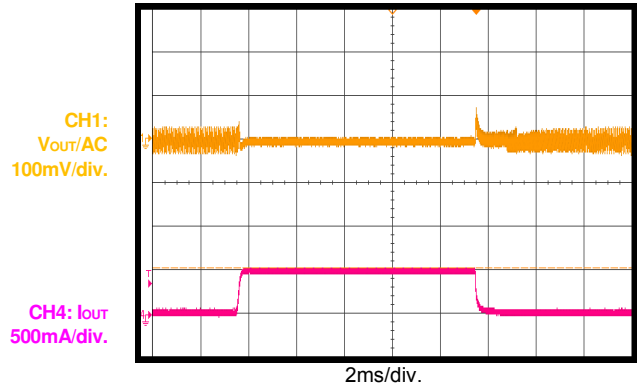
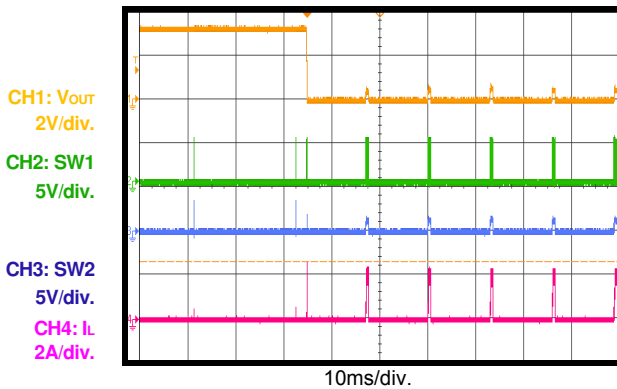
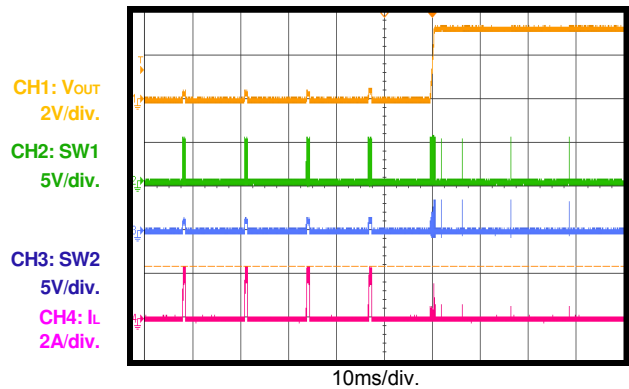
EN Start-Up
 $V_{IN}=5V$, $V_{OUT}=3.3V$, $I_{OUT}=0.5A$

EN Shutdown
 $V_{IN}=5V$, $V_{OUT}=3.3V$, $I_{OUT}=0A$

EVB TEST RESULTS (continued)

Performance curves and waveforms are tested on the evaluation board.

 $V_{IN} = 5V$, $V_{OUT} = 3.3V$, $L = 1\mu H$, $T_A = 25^\circ C$, unless otherwise noted.

EN Shutdown
 $V_{IN}=5V$, $V_{OUT}=3.3V$, $I_{OUT}=0.5A$

Load Transient
 $V_{IN}=5V$, $V_{OUT}=3.3V$, $I_{OUT}=0A-0.5A$, $200mA/\mu s$

SCP Entry
 $V_{IN}=5V$, $V_{OUT}=3.3V$, short output to GND.

SCP Recovery
 $V_{IN}=5V$, $V_{OUT}=3.3V$, short output to GND

PRINTED CIRCUIT BOARD LAYOUT

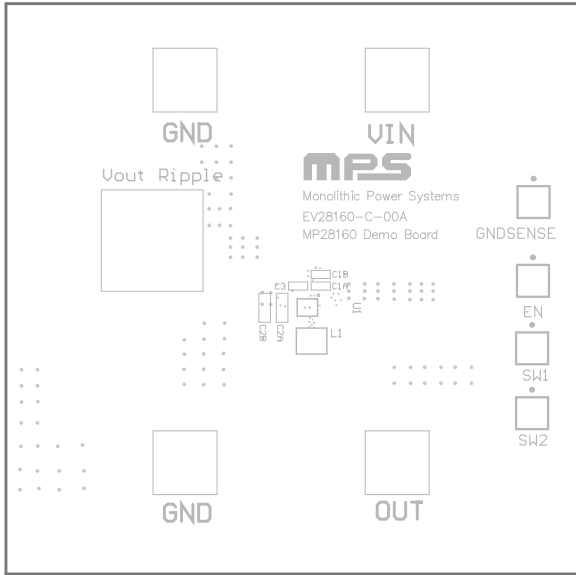

Figure 1—Top Silk Layer

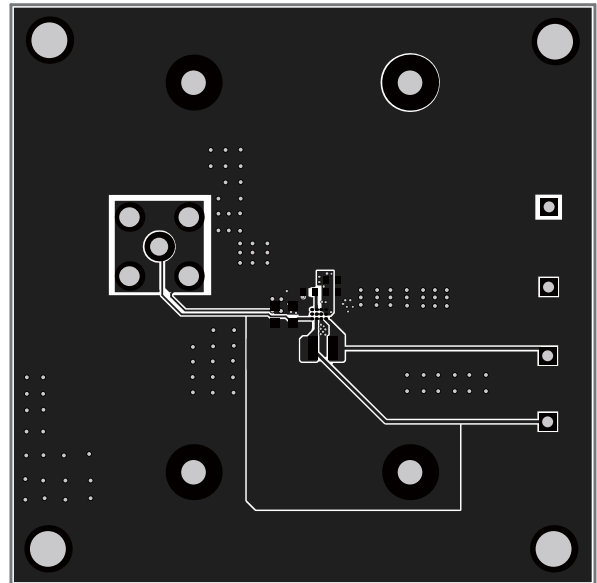

Figure 2—Top Layer

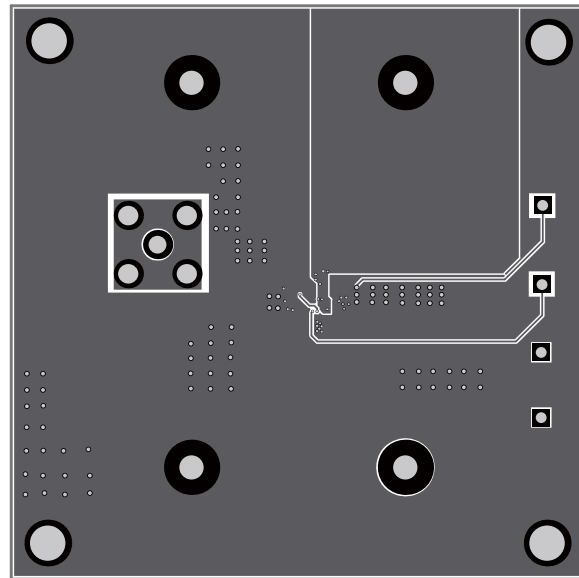

Figure 3—Bottom Layer

QUICK START GUIDE

1. Preset Power Supply between 2.5V and 5.5V.
2. Turn Power Supply off.
3. Connect Power Supply terminals to:
 - a. Positive (+): VIN
 - b. Negative (-): GND
4. Connect Load to:
 - a. Positive (+): VOUT
 - b. Negative (-): GND
5. Turn Power Supply on after making connections. The board will automatically start up.

NOTICE: The information in this document is subject to change without notice. Please contact MPS for current specifications. Users should warrant and guarantee that third party Intellectual Property rights are not infringed upon when integrating MPS products into any application. MPS will not assume any legal responsibility for any said applications.