

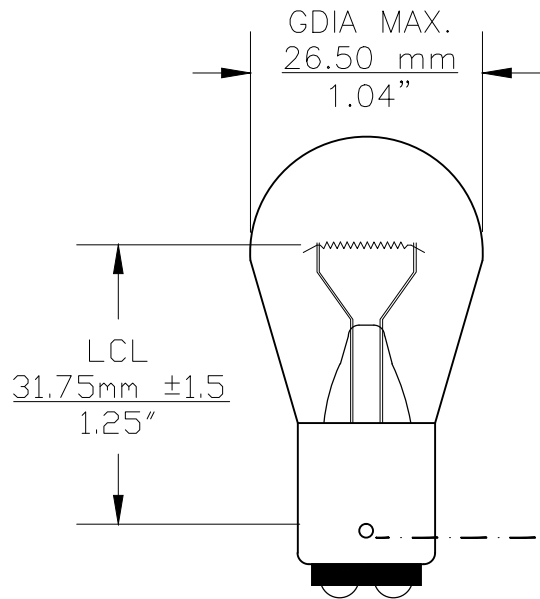

PART NO.	BASE TYPE	DESIGN VOLTS	DESIGN AMPS	MSCD	FILAMENT TYPE	AVERAGE LIFE HOURS	REVISIONS			
							REV #	DESCRIPTION	DATE	APPROVED
8	D.C. BAYONET (BA15d)	8.0V	2.20±10%	20±15%	C-6	500	1	ISSUED	10/23/2014	R.M.

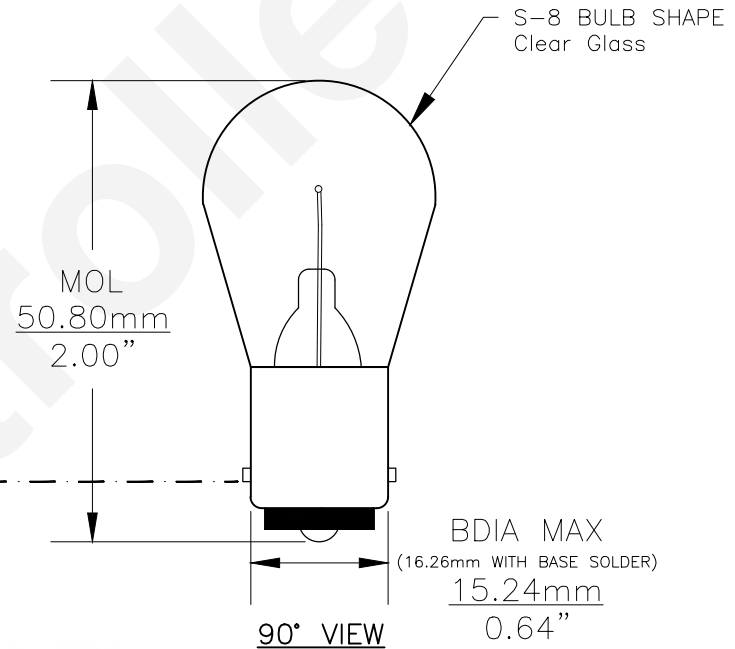

0° VIEW



90° VIEW

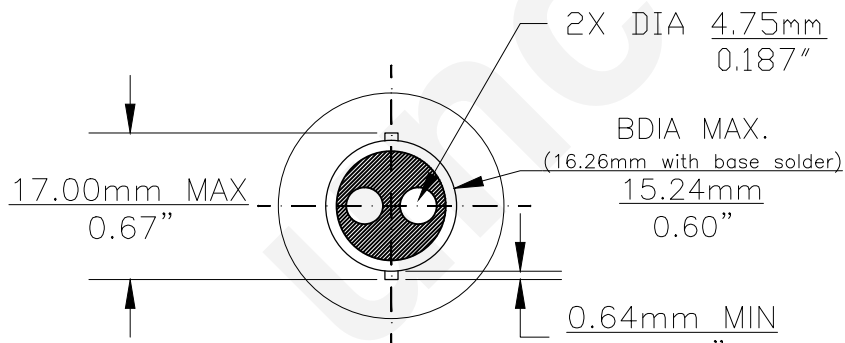

BASE BOTTOM VIEW



Note: Made according to SAE specifications

UNLESS OTHERWISE SPECIFIED: DIMENSIONS ARE IN INCHES TOLERANCES		CEC INDUSTRIES LTD			
DECIMALS .XX ± .05	ANGULAR ± 0.5°	599 BOND STREET		LINCOLNSHIRE, IL 60069	
.XXX ± .010	FRACTIONAL ± 1/64	TITLE LIGHT BULB NO. 8			
DRAWN ROSE MEDINA	DATE 10/23/2014	SIZE A	FSCM NO.	DWG NO. 8	REV 1
DESIGN	SCALE	PLOT SCALE	SHEET 1 OF 1		
MATERIAL	FILE 8.pdf	DRAWING NOT TO SCALE			