

6

5

4

3

2

1

APPROVED: _____
 DATE: _____ TITLE: _____

Rev	AWO #	Description	Date	Appr
-		RELEASED	1/18/19	
A		UPDATED DRAW	3/11/19	AY/TW

D

D

C

C

B

B

A

A

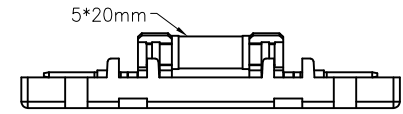
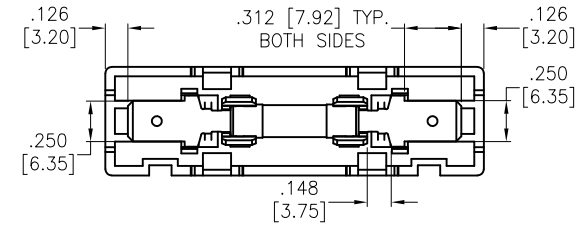
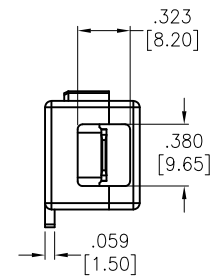
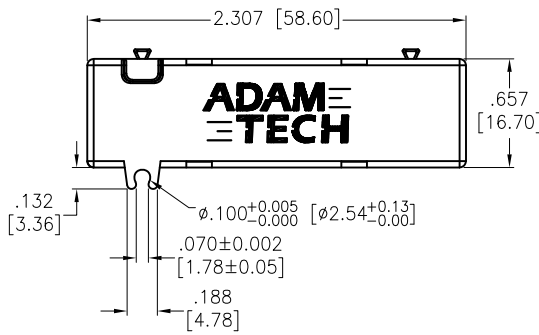
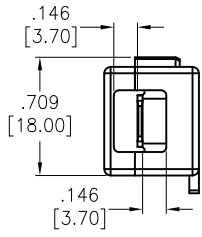
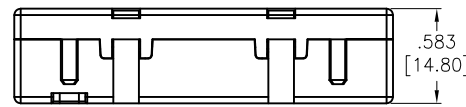
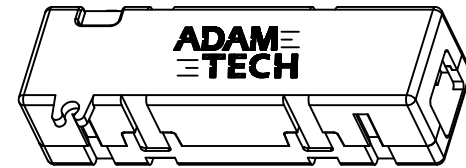

Bottom Cover and Terminal

FH-A-A01
 (1) (2) (3)(4)
 (1). SERIES NO.
 (2). TYPE
 (3). CONTACT TYPE
 A=.250" [6.35mm]
 (4). FUSE TYPE
 01=5x20

SPECIFICATIONS:
 Material:
 Insulator: Thermoplastic, rated UL94V-0
 Insulator color: Black (Top and Bottom)
 Contact: Phosphor Bronze, Tin plated
 Fuse: 5x20mm, 250V, 0.5 Amp
 Temperature Rating:
 Operating temperature: -20°C to +70°C
 Environmental:
 Lead free, RoHS compliant.



UNLESS OTHERWISE SPECIFIED ALL DIMENSIONS ARE INCHES [MM] TOLERANCES: EXCEPT AS NOTED	
INCHES	HOLES
.X ±.10	Ø.X ±.10
.XX ±.020	Ø.XX ±.015
.XXX ±.015	Ø.XXX ±.010
APPROVALS	
DRAWN	AY 1/18/19
CHECKED	TW 1/18/19
APPROVED	

		909 Rahway Avenue, Union, NJ 07083 Phone: 908-687-5000 Fax: 908-687-5710	
TITLE: FUSE HOLDER, .250" QD 5X20 FUSE, 250V 0.5 Amp			
SIZE	PART NO.	REV.	
X	FH-A-A01A	A	
REF:	S00181C	SCALE: NTS	SHEET 1 OF 1

6

5

4

3

2

1