

Weld Field Immune Inductive Proximity Sensors E2AW

Cylindrical Weld Field Immune DC 3-Wire & AC/DC 2-Wire Proximity Sensors Resist Weld Slag Build-up



- Weld field immunity and noise immunity ideal for automotive welding environments
- Coated metal housings resist weld slag
- High-temperature abrasion-resistant coating on sensing face sheds weld slag
- Choose from M12, M18 and M30 connector versions
- DC 3-wire PNP-N.O. or AC/DC 2-wire shielded and unshielded models
- WFI rated to 20,000 Amps @ 1 inch





Ordering Information

Note: Shaded models are normally stocked. Un-shaded models require 2-3 weeks delivery.

■ Sensors With Built-in 4-pin Euro Connector DC 3-Wire, PNP-N.O.

Type	Barrel size	Sensing distance	Connector type	Model PNP N.O.
 Shielded	M12	2mm	4-Pin Euro	E2AW-M12LS02-M1-B1
	M18	5mm	4-Pin Euro	E2AW-M18LS05-M1-B1
	M30	10mm	4-Pin Euro	E2AW-M30LS10-M1-B1
 Unshielded	M12	4mm	4-Pin Euro	E2AW-M12LN04-M1-B1
	M18	8mm	4-Pin Euro	E2AW-M18LN08-M1-B1
	M30	15mm	4-Pin Euro	E2AW-M30LN15-M1-B1

■ Sensors With Built-in 3-pin Micro Connector or Mini Connector AC/DC 2-Wire, N.O.

Type	Barrel size	Sensing distance	Connector type	Model AC/DC 2-Wire N.O.
 Shielded	M18	5mm	3-Pin Micro	E2AW-M18LS05-M4-T1
	M18	5mm	3-Pin Mini	E2AW-M18LS05-MN3-T1
	M18	5mm	3-Pin Mini	E2AW-M18LS05-MN390-T1 See Note
	M30	10mm	3-Pin Micro	E2AW-M30LS10-M4-T1
	M30	10mm	3-Pin Mini	E2AW-M30LS10-MN3-T1
 Unshielded	M18	8mm	3-Pin Micro	E2AW-M18LN08-M4-T1
	M18	8mm	3-Pin Mini	E2AW-M18LN08-MN3-T1
	M18	8mm	3-Pin Mini	E2AW-M18LN08-MN390-T1 See Note
	M30	15mm	3-Pin Micro	E2AW-M30LN15-M4-T1
	M30	15mm	3-Pin Mini	E2AW-M30LN15-MN3-T1

Note: The connector end of the sensor is rotated down 90 degrees. See dimensional drawing.

■ Mating Connector Cordsets

Male views shown

3 Wire DC N.O.

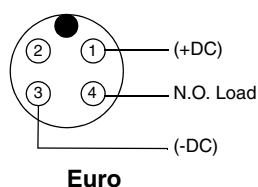

2 Wire AC/DC N.O.

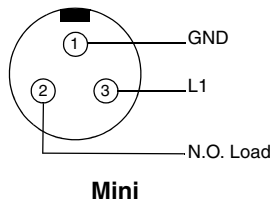

2 Wire AC/DC N.O.

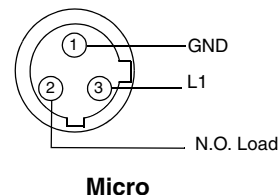

■ Replacement Parts

I.D.	Metal mounting nuts for E2AW			Model	
	Dimensions in millimeters			Clamping locknuts	Black serrated lock washer
	A	B	C		
12mm	(17)	(19.5)	(5.6)	Y92E-80003	Y92E-00139
18mm	(23.8)	(26.9)	(4.1)	Y92E-80002	Y92E-00137
30mm	(36.6)	(42.2)	(4.8)	Y92E-80001	Y92E-00138

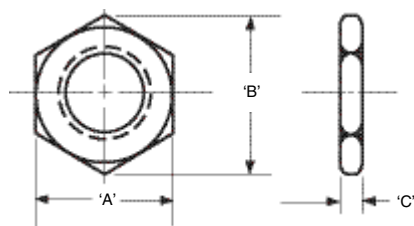

Note: All E2AW Cylindrical Proximity sensors are originally supplied with two (2) clamping locknuts and two (2) serrated lock washers. The replacement hardware listed above is sold in packages of 10.
 Example: Quantity 1 Y92E-80003 consists of 10 12mm mounting nuts only, quantity 1 Y92E-00139 consists of 10 12mm serrated lock washers only.

■ Accessories

Please refer to the Y92E data sheet, publication number D04I-E-01, for a complete listing of proximity sensor accessories.

Specifications

■ DC 3-Wire Sensors

Model	E2AW-M12LS□	E2AW-M12LN□	E2AW-M18LS□	E2AW-M18LN□	E2AWM30LS□	E2AW-M30LN□
Size	M12		M18		M30	
Type	Shielded	Unshielded	Shielded	Unshielded	Shielded	Unshielded
Sensing distance	2mm ± 10%	4mm ± 10%	5mm ± 10%	8mm ± 10%	10mm ± 10%	15mm ± 10%
Sensing object	Ferrous metals approximately the same size as the proximity sensing face for shielded models and twice the size of the sensing face for unshielded models. The specified sensing distances above are based upon tests with mild steel standard targets. Other materials will reduce the sensing range (Sn) as follows: Stainless Steel Sn x 0.85, Brass Sn x 0.5, Copper Sn x 0.46 Aluminum Sn x 0.40					
Hysteresis	10% max. of sensing distance					
Repeatability	< ±1%					
Supply voltage (operating voltage range)	12 to 24 VDC ripple (p-p): 10% max. (10 to 30 VDC) Use a class 2 power source only.					
Current consumption	10 mA max.					
Power-up time	< 45ms					
Response frequency	16Hz (See note)					
Response time	30ms					
Control output	PNP-NO					
Switching capacity	200mA					
Max. switching frequency	15Hz					
Voltage drop	< 2 VDC @ <100mA, < 2.5 VDC @ 200mA					
Leakage current	10µA					
Circuit protection	Reverse Polarity, Short Circuit Protection Non-Latching Type					
Indicators	One bi-color LED Green = Power, Amber = Target, Flashing = SCP		Dual LEDs Green = Power, Amber = Target, Flashing = SCP			
Ambient temperature	Storage: 0 to 70°C Operation: 0 to 70°C					
Temperature drift	10% max. @ 0 to 70°C					
Ambient humidity	Operating and Storage: 35% to 95%					
Voltage influence	±1% max. of sensing distance in rated voltage range ±10%					
Insulation resistance	50 MΩ min. (at 500 VDC) between current carrying parts and case					
Dielectric strength	1,000 VAC at 50/60 Hz for 1 minute between current carrying parts and case					
Vibration resistance	10 to 55 Hz, 1.5-mm double amplitude for 2 hours each in X, Y and Z directions					
Shock resistance	1,000 m/s ² , 10 times each in X, Y and Z directions					
Connection method	M12 4-Pin Euro Connector refer to dimension drawings for pin arrangements					
Standards & listings	—					
Enclosure rating	IEC NEMA	IP67 Degree of protection 1,3,4,6,13				
Material	Body Sensing Face Locknuts	Hard Coat Metal Body PBT with High-Temperature Abrasion-Resistant Coating Anodized Aluminum				
Shipping weight	4 oz.				5 oz.	

Note: The response frequency is an average value. Measurement conditions are as follows: standard target, a distance of twice the standard target distance between targets, and a setting distance of half the sensing distance.

■ AC/DC 2-Wire Sensors

Model	E2AW-M18LS□	E2AW-M18LN□	E2AWM30LS□	E2AW-M30LN□
Size	M18		M30	
Type	Shielded	Unshielded	Shielded	Unshielded
Sensing distance	5mm ± 10%	8mm ± 10%	10mm ± 10%	15mm± 10%
Sensing object	Ferrous metals approximately the same size as the proximity sensing face for shielded models and twice the size of the sensing face for unshielded models. The specified sensing distances above are based upon tests with mild steel standard targets. Other materials will reduce the sensing range (Sn) as follows: Stainless Steel Sn x 0.85, Brass Sn x 0.5, Copper Sn x 0.46 Aluminum Sn x 0.40			
Hysteresis	10% max. of sensing distance			
Repeatability	< ±1%			
Supply voltage	AC/DC 20 to 230V			
Current consumption	N/A			
Power-up time	< 45ms			
Response frequency	16Hz (See note)			
Response time	30ms			
Control output operation	2 Wire Normally Open			
Switching capacity	500mA			
Max. switching frequency	15Hz			
Voltage drop	< 10V			
Leakage current	1.7μA			
Circuit protection	Reverse Polarity, Short Circuit Protection Latching Type			
Indicators	Dual LEDs Red = Power, Green = Target, Flashing = SCP			
Ambient temperature	Storage: 0 to 70°C Operation: 0 to 70°C			
Temperature drift	10% max. @ 0 to 70°C			
Ambient humidity	Operating and Storage: 35% to 95%			
Voltage influence	±1% max. of sensing distance in rated voltage range ±10%			
Insulation resistance	50 MΩ min. (at 500 VDC) between current carrying parts and case			
Dielectric strength	1,000 VAC at 50/60 Hz for 1 minute between current carrying parts and case			
Vibration resistance	10 to 55 Hz, 1.5-mm double amplitude for 2 hours each in X, Y and Z directions			
Shock resistance	1,000 m/s ² , 10 times each in X, Y and Z directions			
Connection method	Micro 3-Pin or Mini 3-Pin (refer to dimension drawings for pin arrangements)			
Standards & listings	UL File E196555 cULus			
Enclosure rating	IEC NEMA	IP67 Degree of protection 1,3,4,6,13		
Material	Body Sensing Face Locknuts	Hard Coat Metal Body PBT with High-Temperature Abrasion-Resistant Coating Anodized Aluminum		
Shipping weight	4 oz.		5 oz.	

Note: The response frequency is an average value. Measurement conditions are as follows: standard target, a distance of twice the standard target distance between targets, and a setting distance of half the sensing distance.

Engineering Data

■ Operating Range (Typical)

Description	Standard size (1008 C.R.S.)	Nominal range ±10%	Recommended	Min.	Max.
M12 Shielded	2" x 2" x .030"	2mm	1.6mm	1mm	1.8mm
M12 Unshielded	2" x 2" x .030"	4mm	3.2mm	1mm	3.6mm
M18 Shielded	2" x 2" x .030"	5mm	4mm	1mm	4.5mm
M18 Unshielded	2" x 2" x .030"	8mm	6.5mm	1mm	7mm
M30 Shielded	2" x 2" x .030"	10mm	8mm	1mm	9mm
M30 Unshielded	2" x 2" x .030"	15mm	12mm	1mm	13mm

■ Influence of Sensing Object Size and Materials

Target size in %	150	125	100 (standard target)	75	50	25	12.5
Deviation from sensing distance in %	+10	+7	0	-7	-14	-27	-45

Operation

■ Timing Chart

	Green LED	Amber LED	Control output
Power off	Off	Off	Off
Power on (no object sensed)	On	Off	Off
Sense object (w/ power on)	On	On	On

■ DC 3-Wire PNP N.O. Output

Output circuit:

(3-wire DC N.O.)

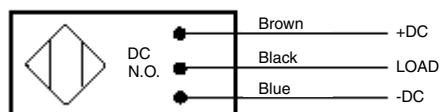

■ AC/DC 2-Wire N.O. Output

Output circuit:

(2-wire AC/DC N.O.)



Connection

Male views shown

3 Wire DC N.O.

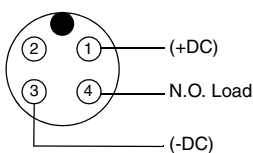

Euro

2 Wire AC/DC N.O.

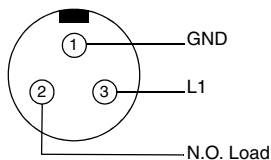

Mini

2 Wire AC/DC N.O.

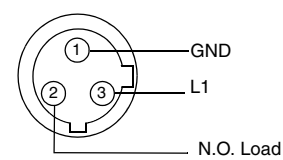

Micro

Sensor Dimensions

Note: Dimensions are in inches and (millimeters).

■ Connector Models (Shielded and Unshielded)

12mm Euro Connector Body threads M12x1

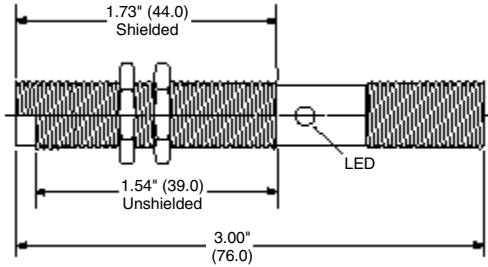

M18 Euro Connector Body threads M18x1

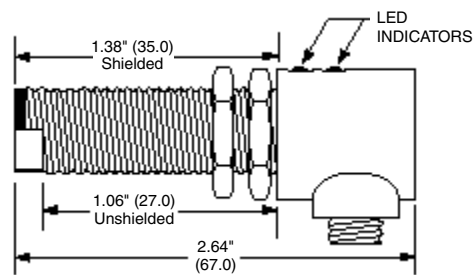
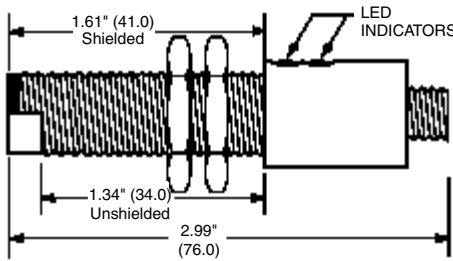

M18 Mini Connector

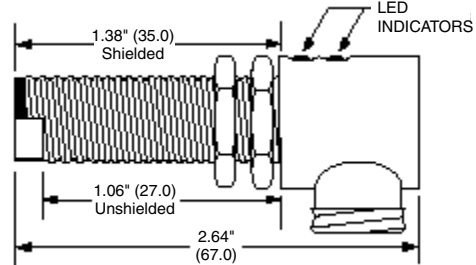
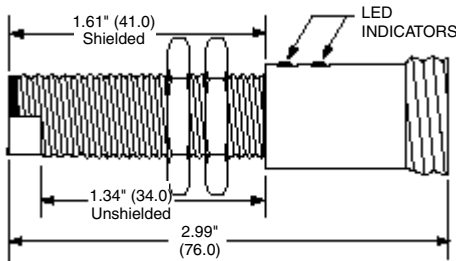

M30 Euro or Micro Connector Body threads M30x1.5

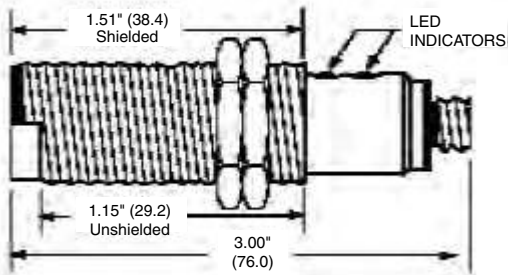

M30 Mini Connector

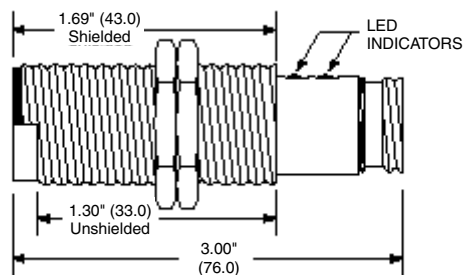

Note: Mounting hole dimensions are in mm and (inches).

■ Mounting Holes

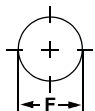

Dimensions	M12	M18	M30
F (mm)	12.5 (0.49) dia.	18.5 (0.73) dia.	30.5 (1.20) dia.

Precautions

■ Sensor Cordsets



Sensor cordsets should never be under tension.



Always allow sufficient slack when connecting.

LED Functions

	10-30V DC		20-230V AC/DC	
	Green	Amber	Red	Green
Power off	Off	Off	Off	Off
Power on load de-energized	On	Off	On	Off
Power on load energized	On	On	Off	On
*SCP mode activated	Both flashing		Both flashing	

Operating Precautions

■ Operating Recommendations

- Always operate the sensor with a resistive load that will limit the current in the circuit to levels that are within the sensor's specifications. Frequent activation of the sensor's short circuit protection could be an indication that a problem exists between the sensor and the load.
- A proximity sensor should not directly control devices such as motors and incandescent bulbs, due to the high inrush currents that typically exceed the maximum load current rating for the sensor.
- Some low voltage control systems may be incompatible with 2-wire AC/DC sensors due to voltage drop or leakage current limitations. Omron recommends careful inspection of the specifications of both the sensor and the system before attempting to install a 2-wire AC/DC sensor in a low-voltage application.
- Never install a sensor such that the target or actuator will make actual contact with the sensing face. Damage to the sensor's face can cause a malfunction or failure.
- Do not attempt to modify the sensor by cutting, grinding, filing, etc.
- All sensors are completely epoxy potted, and as such do not have any serviceable parts inside. Do not remove the cover or tamper with the cable or connector.
- The user should refer to NFPA 70B, RECOMMENDED PRACTICE FOR ELECTRICAL EQUIPMENT MAINTENANCE, published by the National Fire Protection Association, for additional information.

Short Circuit Protection

If the sensor is shorted, the sensor's short circuit protection (SCP) will be activated. SCP is designed to protect the sensor's internal circuitry against damage caused by accidental short circuits. SCP is not intended for protection of external control circuits; the use of short-circuit-protected sensors does **not** eliminate the need for appropriate branch circuit fusing. When a short circuit occurs, both LEDs will flash and the sensor will limit current flow to approximately 2.0mA. The WFI sensors are non-latching type (self-resetting) SCP. The occurrence of a short circuit condition will cause the sensor output to turn off and flash both indicators as long as the shorted condition is present. **This state will automatically self-reset within 120ms after removal of the short circuit.**

LEDs

M12 models have one bi-color LED, but operate the same as the two LED models.

Power Supply

Do not impose an excessive voltage on the E2AW otherwise it may be damaged. Do not impose AC current (100 to 240 VAC) on any DC model otherwise it may be damaged.

Wiring

Be sure to wire the E2AW and load correctly otherwise it may be damaged.

Connection with no loads

Be sure to insert loads when wiring. Make sure to connect a proper load to the E2AW in operation otherwise it may damage internal elements of the sensor.

Do not expose the product to flammable or explosive gases.

Do not disassemble, repair or modify the product.

Tightening torque specifications

Do not tighten locknuts in excess of 10 n.m.

■ Mounting

Sensing Direction

When mounting a sensor it is always preferred to position the target so that it "slides by" the sensor face. This type of mounting will ensure that the sensor face is not damaged by contact with the target. If your application dictates a "head on" approach, it is essential that the target does not use the sensor face as a physical stop. Failure to provide clearance in either the slide-by or head-on modes will result in damage to the sensor and possible failure of the device.

Hysteresis

Hysteresis must be allowed for as the target must move far enough away from the sensing field so that the sensor cannot detect it. If a target is placed within the hysteresis band, vibration of the target can cause the switch to turn on and off rapidly (“chatter”). All sensor manufacturers build in a certain amount of hysteresis to minimize chatter.

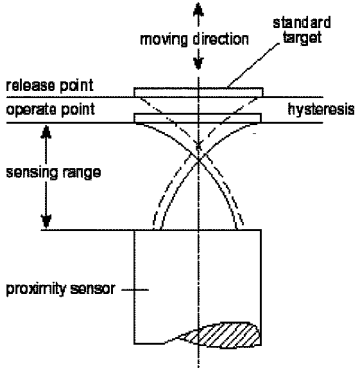

■ Mounting Clearances

Mounting of sensors should follow industry-accepted practices as shown. Failure to properly position the sensor is the single largest cause of field problems.

SHEILDDED SENSORS (FLUSH MOUNTABLE)

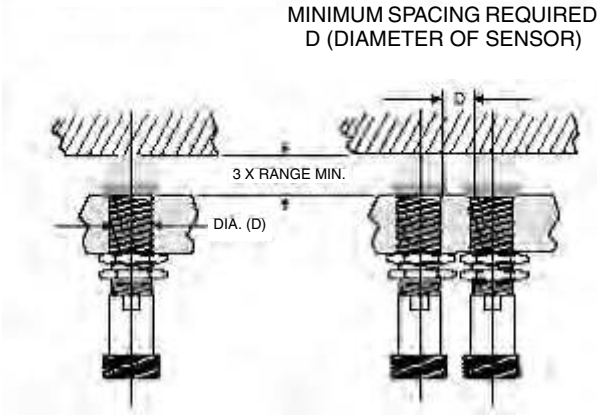

UNSHIELDDED SENSORS (FLUSH MOUNTABLE)

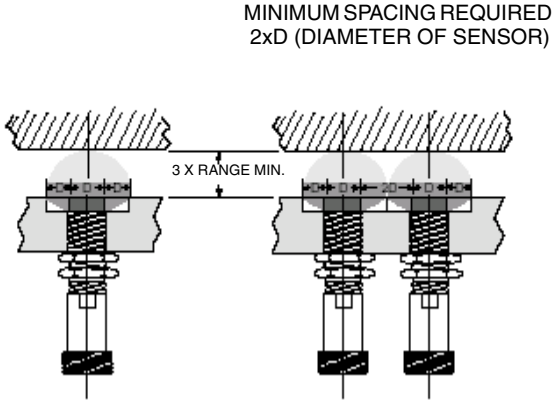

SENSORS MUST BE MOUNTED SUCH THAT SURROUNDING METAL IS NOT IN THE SENSING AREA.

OPPOSING SENSORS

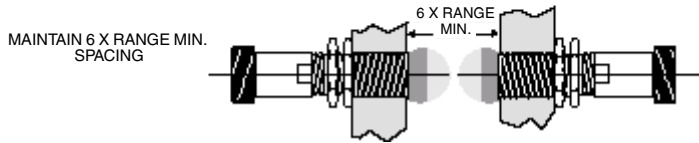

⚠ WARNING
A switch in a protective interlocking circuit should be used with at least one other device that will provide a redundant protective function, and the circuit should be so arranged that either device will interrupt the intended operation of the controlled equipment. (proposed NEMA ICS 2-225.95 St'd.)

⚠ WARNING
Servicing energized industrial control equipment can be hazardous. Severe injury or death can result from electrical shock, burn or unintended actuation of controlled equipment. Recommended practice is to disconnect and lock out control equipment from power sources, and discharge stored energy in capacitors, if present. If it is necessary to work in the vicinity of energized equipment, only qualified personnel should be permitted to perform such work, using all applicable safety practices and protective equipment.

Certain Terms and Conditions of Sale

1. **Offer: Acceptance.** These terms and conditions (these "**Terms**") are deemed part of all catalogs, manuals or other documents, whether electronic or in writing, relating to the sale of goods or services (collectively, the "**Goods**") by Omron Electronics LLC and its subsidiary companies ("**Seller**"). Seller hereby objects to any terms or conditions proposed in Buyer's purchase order or other documents which are inconsistent with, or in addition to, these Terms. Please contact your Omron representative to confirm any additional terms for sales from your Omron company.
2. **Prices.** All prices stated are current, subject to change without notice by Seller. Buyer agrees to pay the price in effect at time of shipment.
3. **Discounts.** Cash discounts, if any, will apply only on the net amount of invoices sent to Buyer after deducting transportation charges, taxes and duties, and will be allowed only if (i) the invoice is paid according to Seller's payment terms and (ii) Buyer has no past due amounts owing to Seller.
4. **Orders.** Seller will accept no order less than \$200 net billing.
5. **Governmental Approvals.** Buyer shall be responsible for, and shall bear all costs involved in, obtaining any government approvals required for the importation or sale of the Goods.
6. **Taxes.** All taxes, duties and other governmental charges (other than general real property and income taxes), including any interest or penalties thereon, imposed directly or indirectly on Seller or required to be collected directly or indirectly by Seller for the manufacture, production, sale, delivery, importation, consumption or use of the Goods sold hereunder (including customs duties and sales, excise, use, turnover and license taxes) shall be charged to and remitted by Buyer to Seller.
7. **Financial.** If the financial position of Buyer at any time becomes unsatisfactory to Seller, Seller reserves the right to stop shipments or require satisfactory security or payment in advance. If Buyer fails to make payment or otherwise comply with these Terms or any related agreement, Seller may (without liability and in addition to other remedies) cancel any unshipped portion of Goods sold hereunder and stop any Goods in transit until Buyer pays all amounts, including amounts payable hereunder, whether or not then due, which are owing to it by Buyer. Buyer shall in any event remain liable for all unpaid accounts.
8. **Cancellation: Etc.** Orders are not subject to rescheduling or cancellation unless Buyer indemnifies Seller fully against all costs or expenses arising in connection therewith.
9. **Force Majeure.** Seller shall not be liable for any delay or failure in delivery resulting from causes beyond its control, including earthquakes, fires, floods, strikes or other labor disputes, shortage of labor or materials, accidents to machinery, acts of sabotage, riots, delay in or lack of transportation or the requirements of any government authority.
10. **Shipping: Delivery.** Unless otherwise expressly agreed in writing by Seller:
 - a. Shipments shall be by a carrier selected by Seller;
 - b. Such carrier shall act as the agent of Buyer and delivery to such carrier shall constitute delivery to Buyer;
 - c. All sales and shipments of Goods shall be FOB shipping point (unless otherwise stated in writing by Seller), at which point title to and all risk of loss of the Goods shall pass from Seller to Buyer, provided that Seller shall retain a security interest in the Goods until the full purchase price is paid by Buyer;
 - d. Delivery and shipping dates are estimates only.
 - e. Seller will package Goods as it deems proper for protection against normal handling and extra charges apply to special conditions.
11. **Claims.** Any claim by Buyer against Seller for shortage or damage to the Goods occurring before delivery to the carrier must be presented in writing to Seller within 30 days of receipt of shipment and include the original transportation bill signed by the carrier noting that the carrier received the Goods from Seller in the condition claimed.
12. **Warranties.** (a) **Exclusive Warranty.** Seller's exclusive warranty is that the Goods will be free from defects in materials and workmanship for a period of twelve months from the date of sale by Seller (or such other period expressed in writing by Seller). Seller disclaims all other warranties, express or implied. (b) **Limitations.** SELLER MAKES NO WARRANTY OR REPRESENTATION, EXPRESS OR IMPLIED, ABOUT NON-INFRINGEMENT, MERCHANTABILITY OR FITNESS FOR A PARTICULAR PURPOSE OF THE GOODS. BUYER ACKNOWLEDGES THAT IT ALONE HAS DETERMINED THAT THE GOODS WILL SUITABLY MEET THE REQUIREMENTS OF THEIR INTENDED USE. Seller further disclaims all warranties and responsibility of any type for claims or expenses based on infringement by the Goods or otherwise of any intellectual property right. (c) **Buyer Remedy.** Seller's sole obligation hereunder shall be to replace (in the form originally shipped with Buyer responsible for labor charges for removal or replacement thereof) the non-complying Good or, at Seller's election, to repay or credit Buyer an amount equal to the purchase price of the Good; provided that in no event shall Seller be responsible for warranty, repair, indemnity or any other claims or expenses regarding the Goods unless Seller's analysis confirms that the Goods were properly handled, stored, installed and maintained and not subject to contamination, abuse, misuse or inappropriate modification. Return of any goods by Buyer must be approved in writing by Seller before shipment. Seller shall not be liable for the suitability or unsuitability or the results from the use of Goods in combination with any electrical or electronic components, circuits, system assemblies or any other materials or substances or environments. Any advice, recommendations or information given orally or in writing, are not to be construed as an amendment or addition to the above warranty.
13. **Damage Limits: Etc.** SELLER SHALL NOT BE LIABLE FOR SPECIAL, INDIRECT OR CONSEQUENTIAL DAMAGES, LOSS OF PROFITS OR PRODUCTION OR COMMERCIAL LOSS IN ANY WAY CONNECTED WITH THE GOODS, WHETHER SUCH CLAIM IS BASED IN CONTRACT, WARRANTY, NEGLIGENCE OR STRICT LIABILITY. Further, in no event shall liability of Seller exceed the individual price of the Good on which liability is asserted.
14. **Indemnities.** Buyer shall indemnify and hold harmless Seller, its affiliates and its employees from and against all liabilities, losses, claims, costs and expenses (including attorney's fees and expenses) related to any claim, investigation, litigation or proceeding (whether or not Seller is a party) which arises or is alleged to arise from Buyer's acts or omissions under these Terms or in any way with respect to the Goods. Without limiting the foregoing, Buyer (at its own expense) shall indemnify and hold harmless Seller and defend or settle any action brought against Seller to the extent that it is based on a claim that any Good made to Buyer specifications infringed intellectual property rights of another party.
15. **Property: Confidentiality.** The intellectual property embodied in the Goods is the exclusive property of Seller and its affiliates and Buyer shall not attempt to duplicate it in any way without the written permission of Seller. Notwithstanding any charges to Buyer for engineering or tooling, all engineering and tooling shall remain the exclusive property of Seller. All information and materials supplied by Seller to Buyer relating to the Goods are confidential and proprietary, and Buyer shall limit distribution thereof to its trusted employees and strictly prevent disclosure to any third party.
16. **Miscellaneous.** (a) **Waiver.** No failure or delay by Seller in exercising any right and no course of dealing between Buyer and Seller shall operate as a waiver of rights by Seller. (b) **Assignment.** Buyer may not assign its rights hereunder without Seller's written consent. (c) **Amendment.** These Terms constitute the entire agreement between Buyer and Seller relating to the Goods, and no provision may be changed or waived unless in writing signed by the parties. (d) **Severability.** If any provision hereof is rendered ineffective or invalid, such provision shall not invalidate any other provision. (e) **Setoff.** Buyer shall have no right to set off any amounts against the amount owing in respect of this invoice. (f) As used herein, "**including**" means "including without limitation".

Certain Precautions on Specifications and Use

1. **Suitability of Use.** Seller shall not be responsible for conformity with any standards, codes or regulations which apply to the combination of the Good in the Buyer's application or use of the Good. At Buyer's request, Seller will provide applicable third party certification documents identifying ratings and limitations of use which apply to the Good. This information by itself is not sufficient for a complete determination of the suitability of the Good in combination with the end product, machine, system, or other application or use. The following are some examples of applications for which particular attention must be given. This is not intended to be an exhaustive list of all possible uses of this Good, nor is it intended to imply that the uses listed may be suitable for this Good:
 - (i) Outdoor use, uses involving potential chemical contamination or electrical interference, or conditions or uses not described in this document.
 - (ii) Energy control systems, combustion systems, railroad systems, aviation systems, medical equipment, amusement machines, vehicles, safety equipment, and installations subject to separate industry or government regulations.
 - (iii) Systems, machines and equipment that could present a risk to life or property. Please know and observe all prohibitions of use applicable to this Good.
2. **Programmable Products.** Seller shall not be responsible for the user's programming of a programmable Good, or any consequence thereof.
3. **Performance Data.** Performance data given in this catalog is provided as a guide for the user in determining suitability and does not constitute a warranty. It may represent the result of Seller's test conditions, and the user must correlate it to actual application requirements. Actual performance is subject to the Seller's Warranty and Limitations of Liability.
4. **Change in Specifications.** Product specifications and accessories may be changed at any time based on improvements and other reasons. It is our practice to change part numbers when published ratings or features are changed or when significant construction changes are made. However, some specifications of the Good may be changed without any notice. When in doubt, special part numbers may be assigned to fix or establish key specifications for your application. Please consult with your Seller's representative at any time to confirm actual specifications of purchased Good.
5. **Errors and Omissions.** The information in this catalog has been carefully checked and is believed to be accurate; however, no responsibility is assumed for clerical, typographical or proofreading errors, or omissions.

NEVER USE THE PRODUCT FOR AN APPLICATION INVOLVING SERIOUS RISK TO LIFE OR PROPERTY WITHOUT ENSURING THAT THE SYSTEM AS A WHOLE HAS BEEN DESIGNED TO ADDRESS THE RISKS, AND THAT THE SELLER'S PRODUCT IS PROPERLY RATED AND INSTALLED FOR THE INTENDED USE WITHIN THE OVERALL EQUIPMENT OR SYSTEM.

Complete "Terms and Conditions of Sale" for product purchase and use are on Omron's website at www.omron.com/oei – under the "About Us" tab, in the Legal Matters section.



OMRON ELECTRONICS LLC

One Commerce Drive
Schaumburg, IL 60173

847-843-7900

For US technical support or other inquiries:

800-556-6766

OMRON CANADA, INC.

885 Milner Avenue
Toronto, Ontario M1B 5V8

416-286-6465

OMRON ON-LINE

Global - <http://www.omron.com>
USA - <http://www.omron.com/oei>
Canada - <http://www.omron.ca>