

SMD Wire Wound Chip Inductors

BWLD Series



BWLD series is the newest open type ferrite wire wound chip inductors. The wire wound ferrite construction supports lower DCR than other open type inductors.

Features

- RoHS compliant
- SMD type wire-wound chip inductor with low DC resistance
- Wide inductance range (0.9uH~100uH)

Applications

- DSC, DVC, MD, PDA
- Portable digital devices

Product Identification

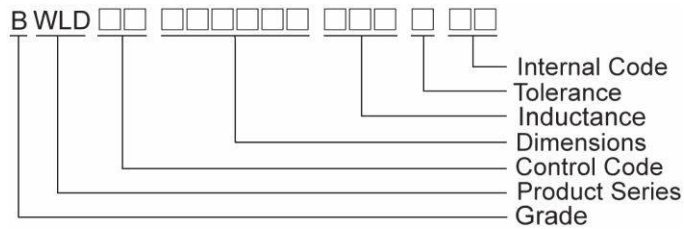

Shape and Dimensions / Recommended Pattern

FIG1

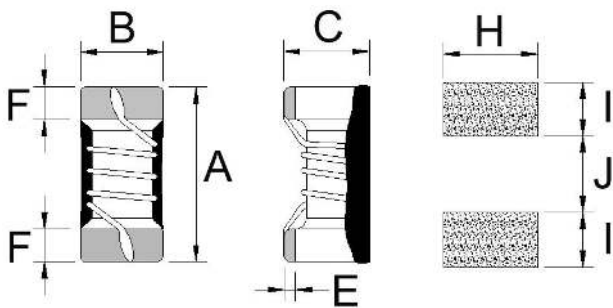
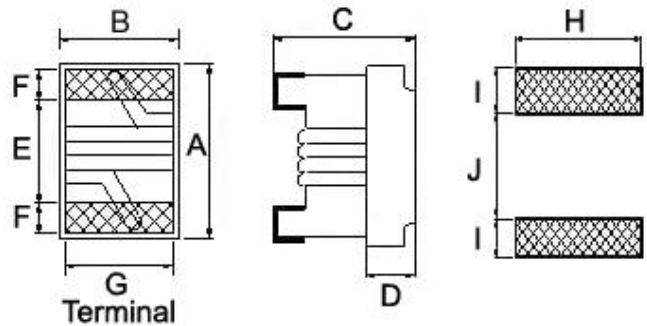

FIG2



Dimensions in mm

TYPE	FIG	A Max	B Max	C Max	D	E	F	G	H	I	J
BWLD00181010	1	1.80±0.1	1.0±0.1	0.95±0.1	-	0.1	0.35	-	1.02	0.64	0.64
BWLD00241715	2	2.4	1.72	1.52	0.70	1.00	0.50	1.27	1.78	1.02	0.76
BWLD00302522	2	2.99	2.50	2.20	0.70	1.52	0.51	2.03	2.54	1.02	1.27

Electrical Characteristics

Part Number	Inductance (uH)	Tolerance (±%)	Test Frequency (MHz)	Q Typ.	SRF (MHz)Typ.	RDC (Ω±30%)	IDC (mA)Typ.	Color
BWLD001810101R0□00	1.0	5 / 10 / 20	7.96	16	390	0.32	700	Black
BWLD001810102R2□00	2.2	5 / 10 / 20	7.96	16	82	0.56	580	Orange
BWLD001810104R7□00	4.7	5 / 10 / 20	7.96	16	51	0.97	420	Violet
BWLD001810106R8□00	6.8	5 / 10 / 20	7.96	16	43	1.5	340	White
BWLD00181010100□00	10	5 / 10 / 20	7.96	14	36	1.85	280	Brown
BWLD00181010150□00	15	5 / 10 / 20	7.96	14	29	2.6	240	Orange
BWLD00181010220□00	22	5 / 10 / 20	2.52	14	24	3.61	200	Green

Note: When ordering, please specify tolerance code. Tolerance: J=±5% , K=±10% , M=±20%

- Operating temperature range - 40°C ~ 105°C(Including self - temperature rise)
- IDC for Inductance drop 10% from its value with current
- Measure Equipment :
 L & Q : Agilent E4991A+Agilent HP16197A(over 1MHz)/Agilent HP4285A(under 1MHz)
 SRF : HP8753D/Agilent E4991A
 RDC : Chroma 16502
 IDC : HP4284A+HP42841A/HP4285A+HP42841A

Test Instruments : Agilent E4991A Material/Impedance Analyzer

Typical L vs. Frequency

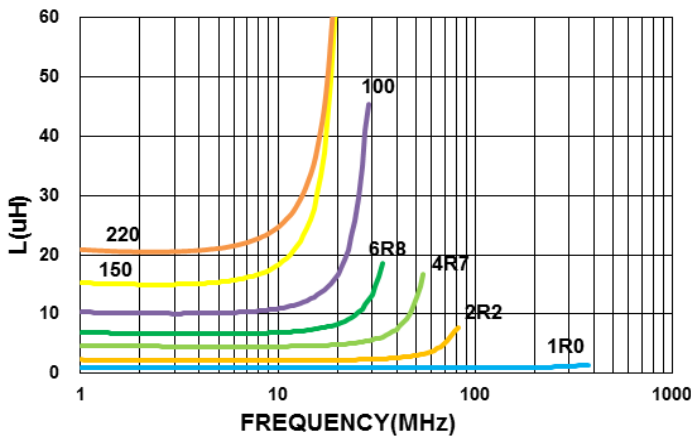

Typical Q vs. Frequency

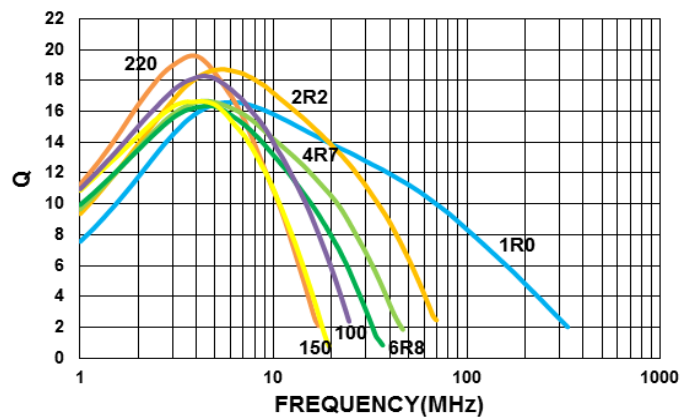

Electrical Characteristics

Part Number	Inductance (uH)	Tolerance (±%)	Test Frequency (MHz)	Q Typ.	SRF (MHz) Min	RDC (Ω±30%)	IDC (mA)	Color
BWLD002417151R0□00	1.0	10 / 20	7.96	18	100	0.10	800	Black
BWLD002417151R5□00	1.5	10 / 20	7.96	18	90	0.18	650	Brown
BWLD002417152R2□00	2.2	10 / 20	7.96	18	70	0.24	550	Red
BWLD002417153R3□00	3.3	10 / 20	7.96	18	55	0.30	450	Orange
BWLD002417154R7□00	4.7	10 / 20	7.96	18	50	0.47	360	Yellow
BWLD002417156R8□00	6.8	10 / 20	7.96	18	60	0.75	290	Green
BWLD00241715100□00	10	10 / 20	2.52	18	25	0.90	290	Blue
BWLD00241715150□00	15	10 / 20	2.52	18	25	1.60	230	Violet
BWLD00241715220□00	22	10 / 20	2.52	18	17	1.95	190	Gray
BWLD00241715330□00	33	10 / 20	2.52	17	15	2.60	120	White
BWLD00241715470□00	47	10 / 20	2.52	17	11	3.90	95	Black
BWLD00241715680□00	68	10 / 20	2.52	17	11	5.50	95	Brown
BWLD00241715101□00	100	10 / 20	1.00	12	9	9.00	70	Red

Note: When ordering, please specify tolerance code. Tolerance: K=±10% , M=±20%

- Operating temperature range - 25°C ~ 105°C(Including self - temperature rise)
- IDC for Inductance drop 10% from its value with current
- Measure Equipment :
 L & Q : Agilent E4991A+Agilent HP16197A(over 1MHz)/Agilent HP4285A(under 1MHz)
 SRF : HP8753D/Agilent E4991A
 RDC : Chroma 16502
 IDC : HP4284A+HP42841A/HP4285A+HP42841A

Test Instruments : Agilent E4991A Material/Impedance Analyzer

Typical L vs. Frequency

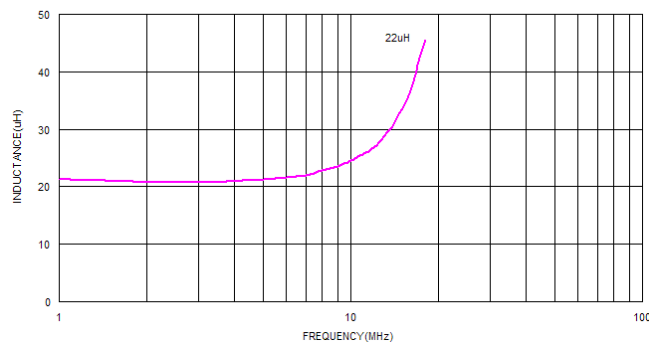

Typical Q vs. Frequency

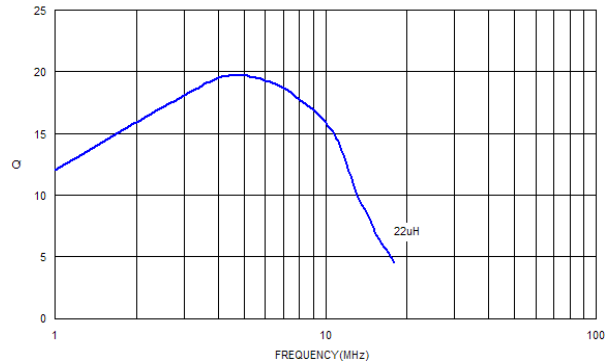

Electrical Characteristics

Part Number	Inductance (uH)	Tolerance (±%)	Test Frequency (MHz)	Q Typ.	SRF (MHz) Min	RDC (Ω) Max	IDC (mA) Typ.	I _{rms} (mA) Max	Color		
									1 ST	2 ND	3 RD
BWLD00302522R90□00	0.9	10	2.5	25	300	0.1	1400	1300	White	Black	Brown
BWLD003025221R1□00	1.1	10	2.5	24	275	0.105	1300	1200	Brown	Brown	Red
BWLD003025221R3□00	1.3	5 / 10	2.5	24	220	0.11	1200	1100	Brown	Orange	Red
BWLD003025221R5□00	1.5	5 / 10	2.5	22	210	0.125	1100	1000	Brown	Yellow	Red
BWLD003025221R9□00	1.9	5 / 10	2.5	22	165	0.14	1000	1000	Brown	White	Red
BWLD003025222R2□00	2.2	5 / 10	2.5	21	75	0.155	950	950	Red	Red	Red
BWLD003025222R7□00	2.7	5 / 10	2.5	22	57	0.19	800	900	Red	Violet	Red
BWLD003025223R3□00	3.3	5 / 10	2.5	21	54	0.21	750	800	Orange	Orange	Red
BWLD003025223R9□00	3.9	5 / 10	2.5	21	50	0.22	700	800	Orange	White	Red
BWLD003025224R7□00	4.7	5 / 10	2.5	27	48	0.435	700	650	Yellow	Violet	Red
BWLD003025225R8□00	5.8	5 / 10	2.5	21	33	0.28	550	750	Green	Gray	Red
BWLD003025226R8□00	6.8	5 / 10	2.5	20	28	0.315	500	700	Blue	Gray	Red
BWLD003025228R2□00	8.2	5 / 10	2.5	20	24	0.395	500	650	Gray	Red	Red
BWLD00302522100□00	10	5 / 10	2.5	22	20	0.48	450	550	Brown	Black	Orange

Note: When ordering, please specify tolerance code. Tolerance: J=±5% , K=±10%

- Operating temperature range - 25°C ~ 105°C(Including self - temperature rise)
- IDC for Inductance drop 10% from its value with current
- I_{rms} for a 40°C temperature rise from 25°C ambient with current
- Measure Equipment :

L : Agilent E4991A/HP4287A+16197A

SRF : HP8753D/Agilent E4991A

RDC : Chroma 16502

IDC : HP4284A+HP42841A/HP4285A+HP42841A

Test Instruments : Agilent E4991A Material/Impedance Analyzer

Typical L vs. Frequency

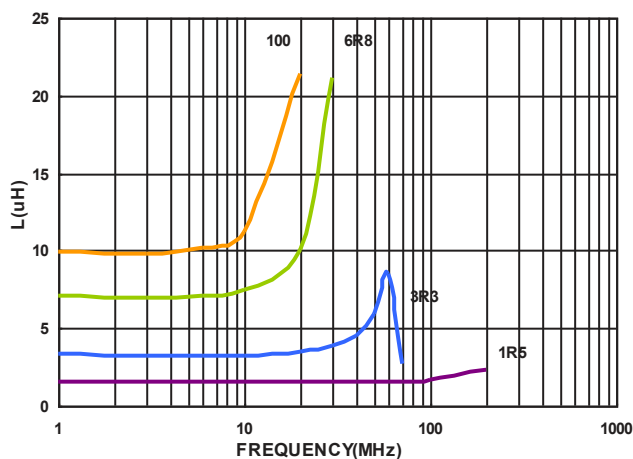

Typical Q vs. Frequency

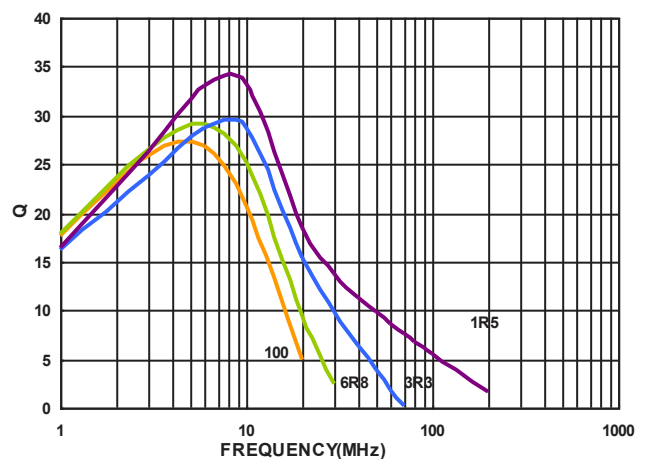

Packaging Specifications

Tape Dimensions

FIG1

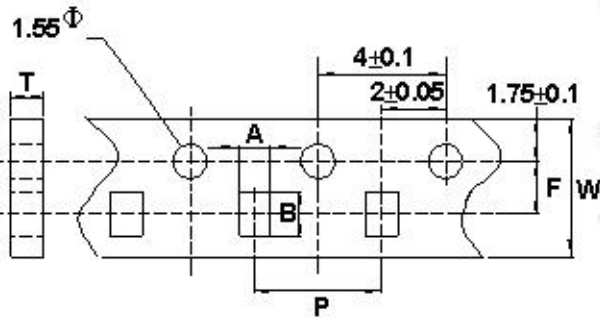

Tape Material

Carrier Tape: Paper
Cover Tape: Polystyrene

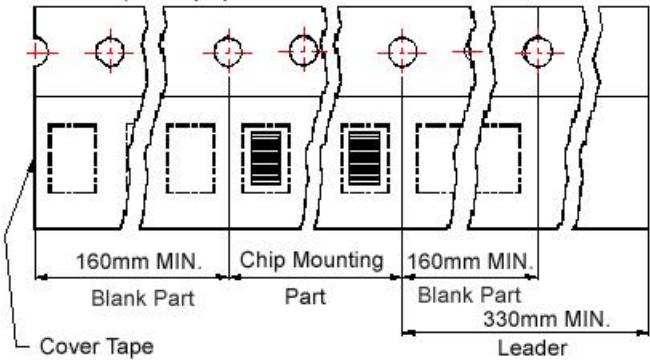

Reel Dimensions

FIG2

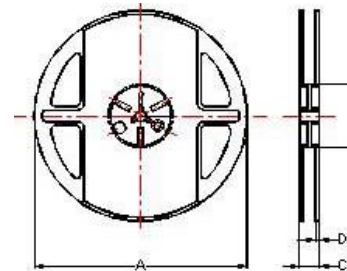
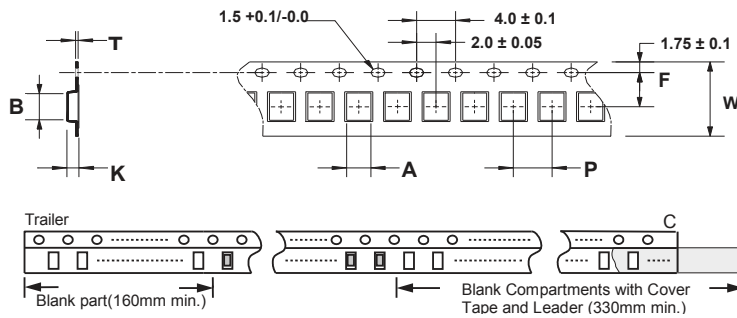

Dimensions in mm

TYPE	FIG	Tape Dimensions							Reel Dimensions				Quantity PCS / REEL
		A	B	T	W	P	F	K	A	B	C	D	
BWLD00181010	1	1.20	2.42	1.1	8	4	3.5	-	178	60	12	1.5	4000
BWLD00241715	2	1.60	2.42	0.22	8	4	3.5	1.45	178	60	12	1.5	2000
BWLD00302522	2	2.40	2.93	0.26	8	4	3.5	2.25	178	60	12	1.5	2000

For More Information:

Americas - prodinfo_power_americas@yageo.com | Europe - prodinfo_power_emea@yageo.com | Asia - prodinfo_power_asia@yageo.com

Performance warranty of products offered on this data sheet is limited to the parameters specified. Data is subject to change without notice. Other brand and product names mentioned herein may be trademarks or registered trademarks of their respective owners. © Copyright, 2022. Pulse Electronics, Inc. All rights reserved.